



DISTRICT OF COLUMBIA

# EROSION AND SEDIMENT CONTROL MANUAL

**September 2017**





**Prepared Under:**

Grant No. 2015-1502-WPD

**Prepared for:**

Department of Energy and Environment  
Watershed Protection Division  
1200 First Street NE  
Washington, DC 20002  
<https://doee.dc.gov/>



**Prepared by:**

Center for Watershed Protection, Inc.  
3290 North Ridge Road, Suite 290  
Ellicott City, MD 21043  
<http://www.cwp.org/>



## Acknowledgements

An extensive accomplishment such as this requires the dedication and cooperative efforts of many individuals. Dr. Hamid Karimi, Director of Natural Resources; Sheila Besse, Associate Director of Watershed Protection; Jeff Seltzer, Associate Director of Water Quality; and Timothy Karikari, Branch Chief of Building Permit Plan Review deserve credit for their overall leadership and support for this project.

### **Project Manager**

Julienne Bautista, E.I.T., DOEE-Building Permit Plan Review

### **Lead Authors**

Julienne Bautista, E.I.T., DOEE-Building Permit Plan Review

Laura Gardner, P.E., Center for Watershed Protection

### **Editor**

Sherry Schwechten, DOEE-Natural Resources

### **Contributors and Peer Reviewers**

Annemarie Abbondanzo, Ecosystem Services

Alit Balk, DDOT-Urban Forestry Division

Nykia Barnes, DOEE-Building Permit Plan Review

Joe Battiatia, P.E., (Center for Watershed Protection)/City of Hopewell, VA

Jerusalem Bekele, DOEE-Monitoring and Assessment

Josh Burch, DOEE-Restoration

Colin R. Burrell, DOEE-Inspection and Enforcement

Deb Caraco, P.E., Center for Watershed Protection

Trevor Cone, P.E., CFM, DOEE-Water Resource Protection and Mitigation

Walter Caldwell, DOEE-Construction and Maintenance

Patrick Cruz, E.I.T., A. Morton Thomas & Associates, Inc.

Ari Daniels, E.I.T., Center for Watershed Protection

Elias Demessie, P.E., CFM, DOEE-Building Permit Plan Review

Jennifer Dietzen, DOEE-Water Resource Protection and Mitigation

Diane Douglas, DOEE-Standards and TMDL

Matthew Espie, DOEE- Water Resource Protection and Mitigation

Earl Eutsler, DDOT-Urban Forestry Division

Greg Hoffmann, P.E., Center for Watershed Protection

Bill Hodgins, P.E., Center for Watershed Protection

Timothy Karikari, P.E., CPESC, CFM, DOEE-Building Permit Plan Review

Massoud Massoumi, P.E., DOEE-Building Permit Plan Review

Markku McGlynn, (DOEE-Construction and Maintenance)/Biohabitats

Kip Mumaw, P.E., Ecosystem Services

Abdi Musse, P.E., CFM, DOEE-Building Permit Plan Review

Peter Nwangwu, DOEE-Construction and Maintenance

Damien Ossi, DOEE-Wildlife Management

Carlos Ostria, P.E., A. Morton Thomas & Associates, Inc.

Ricardo Payne, DOEE-Watershed Protection

Lillian Peterson, DOEE-Illicit Discharge and NPDES

Phetmano Phannavong, P.E., CFM, DOEE-Water Resource Protection and Mitigation

Stephen Reiling, DOEE-Restoration

Steve Saari, DOEE-Restoration

Nicoline Schulerbrandt, DOEE-Monitoring and Assessment

Mary Searing, P.E., (DOEE-Standards and TMDL)/Brudis & Associates, Inc.

Jeff Seltzer, P.E., DOEE-Water Quality

Jose Soliz, A. Morton Thomas & Associates, Inc.

Bill Stack, P.E., Center for Watershed Protection

Chris Tomsic, P.E., Ecosystem Services

Brian VanWye, DOEE-Regulatory Review Division

# Contents

<b>Acknowledgements</b> .....	<b>iv</b>
<b>List of Tables</b> .....	<b>viii</b>
<b>List of Figures</b> .....	<b>x</b>
<b>List of Details</b> .....	<b>xi</b>
<b>Index of Standard Symbols</b> .....	<b>xv</b>
<b>Chapter 1 Introduction</b> .....	<b>21</b>
1.1 Impacts of Erosion .....	21
1.2 Principles of Erosion and Sediment Control.....	21
1.3 The District’s Erosion and Sediment Control Program .....	24
1.4 NPDES Construction General Permit and Stormwater Pollution Prevention Plan .....	30
1.5 Erosion and Sediment Control Principles for the Urban Environment.....	30
<b>Chapter 2 Soil Stabilization</b> .....	<b>35</b>
2.1 Stabilized Construction Entrance.....	35
2.2 Stabilized Construction Entrance with Wash Rack .....	38
2.3 Construction Road Stabilization .....	41
2.4 Construction Debris Ground Cover .....	43
2.5 Land Grading .....	46
2.6 Topsoiling .....	50
2.7 Mulching .....	52
2.8 Compost Blankets .....	56
2.9 Rolled Erosion Control Products .....	59
2.10 Vegetative Stabilization.....	65
2.11 Polyacrylamide .....	84
<b>Chapter 3 Sediment Barriers and Filters</b> .....	<b>89</b>
3.1 Silt Fence .....	89
3.2 Super Silt Fence .....	93
3.3 Filter Sock.....	97
3.4 Organic Filter Berm .....	103
3.5 Straw Bale Dike .....	106
3.6 Culvert Inlet Protection.....	109
3.7 Storm Drain Inlet Protection.....	115
3.8 Stone Check Dams.....	125
3.9 Inlet Filter Bags.....	130

3.10	Silt Fence on Pavement.....	134
<b>Chapter 4</b>	<b>Conveyance .....</b>	<b>137</b>
4.1	Diversion Fence .....	137
4.2	Dike/Swale.....	140
4.3	Earth Dike .....	143
4.4	Temporary Swales .....	150
4.5	Long Term or Permanent Flumes, Chutes .....	155
4.6	Permanent Channel .....	164
4.7	Pipe Slope Drain .....	167
4.8	Temporary Storm Drain Diversion .....	171
<b>Chapter 5</b>	<b>Water Control.....</b>	<b>173</b>
5.1	Rock Outlet Protection.....	173
5.2	Plunge Pool/Stilling Basin .....	186
5.3	Level Spreader .....	190
<b>Chapter 6</b>	<b>Sediment Traps and Basins .....</b>	<b>193</b>
6.1	Sediment Traps .....	193
6.2	Sediment Basins.....	203
<b>Chapter 7</b>	<b>Dewatering .....</b>	<b>227</b>
7.1	Removable Pumping Station.....	227
7.2	Sump Pit.....	231
7.3	Portable Sediment Tank.....	234
7.4	Pumped Water Filter Bags.....	238
<b>Chapter 8</b>	<b>Waterways and Stream Protection .....</b>	<b>243</b>
8.1	Stream Protection Preface.....	243
8.2	Temporary Access Stream Crossings .....	248
8.3	Temporary Access Ford.....	251
8.4	Temporary Access Culvert .....	254
8.5	Temporary Access Bridge.....	258
8.6	Access Roads .....	261
8.7	Temporary Stockpile and Disposal Areas.....	264
8.8	Pump-Around Practice.....	266
8.9	Culvert Pipe with Access Road.....	270
8.10	Diversion Pipe.....	274
8.11	Slotted Pipe Diversion .....	279

8.12	Temporary Channel Diversion.....	283
8.13	Sandbag/Stone Channel Diversion .....	288
8.14	Turbidity Curtain .....	292
8.15	Portable Dams/Barriers .....	299
8.16	Construction Platform.....	303
8.17	Utility Crossing.....	305
8.18	Culvert Installation.....	310
8.19	Dewatering Basins .....	314
<b>Chapter 9</b>	<b>Other Practices .....</b>	<b>317</b>
9.1	Dust Control.....	317
9.2	On-site Concrete Washout Structure .....	320
9.3	Tree Protection and Preservation .....	324
9.4	Flocculants .....	331
9.5	New Products and Procedures .....	335
<b>Chapter 10</b>	<b>References .....</b>	<b>337</b>
<b>Appendix A</b>	<b>Material Specifications.....</b>	<b>A-1</b>
A.1	Geotextile Fabrics .....	A-1
A.2	Silt Fence .....	A-2
A.3	Stone .....	A-3
A.4	Soil Texture.....	A-4
<b>Appendix B</b>	<b>Open Channel Hydraulics .....</b>	<b>B-1</b>
B.1	Introduction.....	B-1
B.2	Manning’s Equations for Open Channel Flow .....	B-1
B.3	Variable Parameters .....	B-2
B.4	Example Design Exercises.....	B-7
<b>Appendix C</b>	<b>Definitions .....</b>	<b>C-1</b>

## List of Tables

Table 1.1 Principles of Erosion and Sediment Control.....	24
Table 1.2 The District’s ESC Plan Requirements.....	27
Table 1.3 Timelines in the Stormwater Rule .....	28
Table 1.4 Inspections during Construction .....	29
Table 1.5 Special ESC Design Considerations in the District’s Urban Environment .....	33
Table 2.1 Temporary Erosion Control Matting Selection Criteria .....	60
Table 2.2 Quality of Seed .....	66
Table 2.3 Temporary Seeding Summary .....	67
Table 2.4 Temporary Seeding for Site Stabilization.....	68
Table 2.5 Permanent Seeding Summary.....	69
Table 2.6 Recommended Permanent Seeding Mixtures by Site Condition or Purpose .....	70
Table 2.7 Selected List of Permanent Herbaceous Seeding Mixtures .....	71
Table 2.8 Recommended Planting Dates for Permanent Cover .....	77
Table 2.9 Maintenance Fertilization for Permanent Seeding.....	83
Table 3.1 Silt Fence Slope Length and Fence Length Constraints .....	89
Table 3.2 Physical Properties of Silt Fence Geotextile.....	90
Table 3.3 Super Silt Fence Slope Length and Fence Length Constraints.....	93
Table 3.4 Filter Sock Sizing, Slope Length Constrains, and Flow-Through Rates .....	98
Table 3.5 Compost Material Specifications.....	98
Table 3.6 Organic Filter Berm Design Constraints .....	104
Table 3.7 Organic Filter Berm Design Criteria .....	104
Table 3.8 Straw Bale Slope Length and Dike Length Constraints .....	106
Table 3.9 Geotextile Material Properties for Inlet Filter Bag.....	131
Table 3.10 Silt Fence on Pavement Slope Length and Fence Length Constraints .....	134
Table 4.1 Perimeter Dike/Swale Design Criteria.....	141
Table 4.2 Earth Dike Design Criteria .....	143
Table 4.3 Earth Dike Selection Criteria.....	145
Table 4.4 Design Criteria Based on Stabilization Type.....	146
Table 4.5 Temporary Swale Design Criteria .....	150
Table 4.6 Temporary Swale Selection Criteria.....	151
Table 4.7 Stone Flume Carrying Capacity (25% Safety Factor) .....	157
Table 4.8 Concrete Flume Carrying Capacity (25% Safety Factor).....	158
Table 4.9 Design Criteria for Pipe Slope Drains .....	168



Table 5.1 Riprap Sizes and Thicknesses.....	175
Table 5.2 Minimum Dimension for Level Spreader.....	190
Table 6.1 Example Sediment Trap Sizing.....	194
Table 6.2 Pipe Outlet Diameter Sizing.....	196
Table 6.3 Weir Length.....	196
Table 6.4 Head Requirements for Skimmer Design.....	205
Table 6.5 Corrugated Metal Pipe Flow (cfs).....	209
Table 6.6 Reinforced Concrete Pipe Flow (cfs).....	210
Table 6.7 Concentric Trash Rack and Anti-Vortex Device.....	212
Table 6.8 Design Data for Earth Spillway (use in conjunction with Detail 602.5).....	217
Table 7.1 Filter Bag Geotextile Criteria.....	239
Table 8.1 Physical Properties of Turbidity Curtain Fabric.....	293
Table 9.1 Spray-on Adhesives Guidance.....	318
Table A.1 Geotextile Fabrics.....	A-2
Table A.2 Stone Size.....	A-3
Table A.3 Stone for Gabion Baskets.....	A-3
Table B.1 Manning’s Roughness Coefficients (n).....	B-3
Table B.2 Steepest Permissible Side Slopes and Minimum Lining Thickness.....	B-5
Table B.3 Maximum Permissible Velocities for Channel Lining Materials.....	B-6

## List of Figures

Figure 1.1 Cover and management factors (Wischmeier and Smith, 1978).....	22
Figure 1.2 Flowchart for determining ESC and stormwater management requirements in the District.....	26
Figure 1.3 New DC, Maryland, and Virginia housing units in 2014.....	30
Figure 2.1 Incremental stabilization – cut.....	81
Figure 2.2 Incremental stabilization – fill.....	82
Figure 3.1 At-grade inlet protection method.....	99
Figure 3.2 Curb inlet protection method.....	99
Figure 3.3 Check dam spacing lookup, based on height and longitudinal slope. ....	127
Figure 4.1 Paved flume with french drain. ....	156
Figure 4.2 Cross section of riprap/gabion flume. ....	157
Figure 4.3 Use of silt fence to increase flow path when discharging to sediment trap. ....	168
Figure 5.1 Design of outlet protection – minimum tailwater condition. ....	176
Figure 5.2 Design of outlet protection – maximum tailwater condition.....	177
Figure 6.1 Sediment basin storage volume.....	204
Figure 6.2 Skimmer orifice design.....	206
Figure 6.3 Principle spillway. ....	207
Figure 6.4 Riser inflow curves.....	211
Figure 6.5 Anti-seep collars.....	214
Figure 6.6 Anti-seep collar design.....	215
Figure 8.1 Construction platform for major streambank restoration. ....	304
Figure 9.1 Critical root zone.....	326
Figure 9.2 Tree protection zone.....	327
Figure A.1 Soil textural triangle. ....	A-4
Figure B.1 Hydraulic parameters of basic channel sections.....	B-2
Figure B.2 Manning’s roughness coefficient (n) based on flow depth and stone size. ....	B-4
Figure B.3 Maximum flow velocity versus depth of flow for concrete-lined channels (image adapted from NRCS, NHCP 2010).....	B-7

## List of Details



Detail 1 – 201.1 Stabilized Construction Entrance .....	37
Detail 2 – 202.1 Stabilized Construction Entrance with Wash Rack .....	40
Detail 3 – 204.1 Construction Debris Ground Cover .....	45
Detail 4 – 205.1 Land Grading .....	49
Detail 5 – 209.1 Rolled Erosion Control Products Slope Stabilization .....	63
Detail 6 – 209.2 Rolled Erosion Control Products Channel Stabilization.....	64
Detail 7 – 301.1 Silt Fence - 1 .....	91
Detail 8 – 301.2 Silt Fence - 2 .....	92
Detail 9 – 302.1 Super Silt Fence - 1 .....	95
Detail 10 – 302.2 Super Silt Fence - 2 .....	96
Detail 11 – 303.1 Filter Sock - 1 .....	101
Detail 12 – 303.2 Filter Sock - 2.....	102
Detail 13 – 304.1 Organic Filter Berm .....	105
Detail 14 – 305.1 Straw Bale Dike .....	108
Detail 15 – 306.1 Culvert Inlet Protection - 1 .....	112
Detail 16 – 306.2 Culvert Inlet Protection - 2.....	113
Detail 17 – 306.3 Culvert Inlet Protection - 3.....	114
Detail 18 – 307.1 Standard Inlet Protection.....	119
Detail 19 – 307.2 At Grade Inlet Protection .....	120
Detail 20 – 307.3 Curb Inlet Protection .....	121
Detail 21 – 307.4 Median Inlet Protection.....	122
Detail 22 – 307.5 Standard Inlet Guard .....	123
Detail 23 – 307.6 Block and Gravel Drop Inlet Protection.....	124
Detail 24 – 308.1 Stone Check Dam.....	129
Detail 25 – 309.1 Inlet Filter Bag Curbed Roadway .....	132
Detail 26 – 309.2 Inlet Filter Bag Roadway Swale or Channel.....	133
Detail 27 – 310.1 Silt Fence on Pavement .....	136
Detail 28 – 401.1 Diversion Fence .....	139
Detail 29 – 402.1 Dike-Swale.....	142
Detail 30 – 403.1 Earth Dike .....	148
Detail 31 – 403.2 Earth Dike Mountable Berm .....	149
Detail 32 – 404.1 Temporary Swales.....	154
Detail 33 – 405.1 Paved Flume.....	161



Detail 34 – 405.2 Energy Dissipator - 1 .....	162
Detail 35 – 405.3 Energy Dissipator - 2 .....	163
Detail 36 – 407.1 Pipe Slope Drain .....	170
Detail 37 – 501.1 Rock Outlet Protection - 1.....	183
Detail 38 – 501.2 Rock Outlet Protection - 2.....	184
Detail 39 – 501.3 Rock Outlet Protection - 3.....	185
Detail 40 – 502.1 Plunge Pool .....	189
Detail 41 – 503.1 Level Spreader .....	192
Detail 42 – 601.1 Pipe Outlet Sediment Trap - ST I.....	201
Detail 43 – 601.2 Stone Outlet Sediment Trap - ST II .....	202
Detail 44 – 602.1 Baffle Boards .....	221
Detail 45 – 602.2 Skimmer .....	222
Detail 46 – 602.3 Concentric Trash Rack and Anti-Vortex Device .....	223
Detail 47 – 602.4 Typical Anti-Seep Collars.....	224
Detail 48 – 602.5 Emergency Spillway .....	225
Detail 49 – 701.1 Removable Pumping Station.....	230
Detail 50 – 702.1 Sump Pit.....	233
Detail 51 – 703.1 Portable Sediment Tank (Horizontal) .....	236
Detail 52 – 703.2 Portable Sediment Tank (Vertical).....	237
Detail 53 – 704.1 Pumped Water Filter Bags .....	241
Detail 54 – 803.1 Temporary Access Ford .....	253
Detail 55 – 804.1 Temporary Access Culvert.....	257
Detail 56 – 805.1 Temporary Access Bridge.....	260
Detail 57 – 806.1 Access Roads .....	263
Detail 58 – 808.1 Pump Around Practice .....	269
Detail 59 – 809.1 Culvert Pipe with Access Road.....	273
Detail 60 – 810.1 Diversion Pipe - 1.....	277
Detail 61 – 810.2 Diversion Pipe - 2.....	278
Detail 62 – 811.1 Slotted Pipe Diversion.....	282
Detail 63 – 812.1 Temporary Channel Diversion.....	287
Detail 64 – 813.1 Sandbag/Stone Channel Diversion.....	291
Detail 65 – 814.1 Turbidity Curtain - 1 .....	296
Detail 66 – 814.2 Turbidity Curtain - 2 .....	297
Detail 67 – 814.3 Turbidity Curtain - 3 .....	298

Detail 68 – 815.1 Portable Dams/Barriers - 1 .....	301
Detail 69 – 815.2 Portable Dams/Barriers - 2.....	302
Detail 70 – 817.1 Utility Crossing - 1.....	308
Detail 71 – 817.2 Utility Crossing - 2.....	309
Detail 72 – 818.1 Culvert Installation Stages 1 & 2 .....	312
Detail 73 – 818.2 Culvert Installation Stages 3 & 4 .....	313
Detail 74 – 819.1 Dewatering Basins .....	316
Detail 75 – 902.1 Onsite Concrete Washout Structure - 1.....	322
Detail 76 – 902.2 Onsite Concrete Washout Structure - 2.....	323
Detail 77 – 903.1 Tree Protection.....	329
Detail 78 – 903.2 Tree Root Protection with Silt Fence .....	330



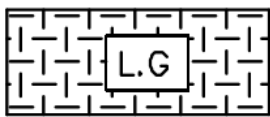
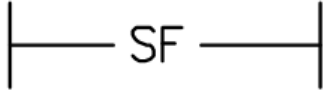
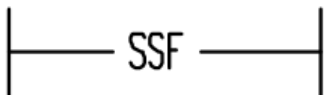
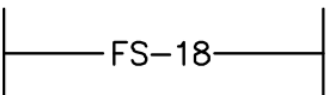
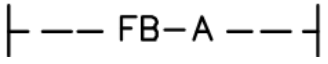
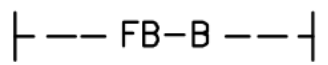

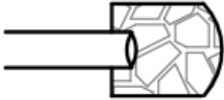
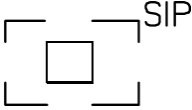
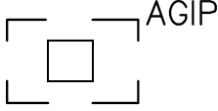
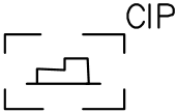
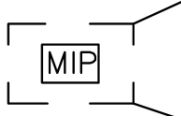
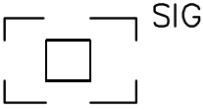

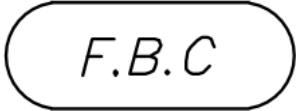
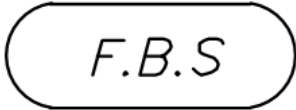





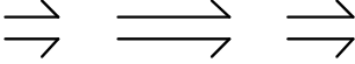
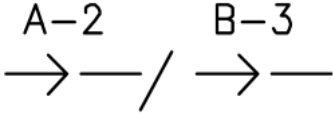

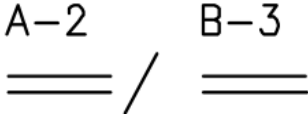
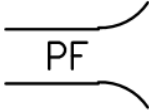
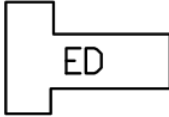
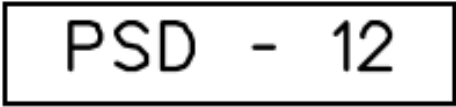

## Index of Standard Symbols



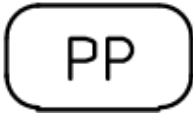
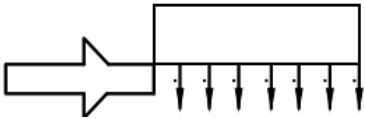

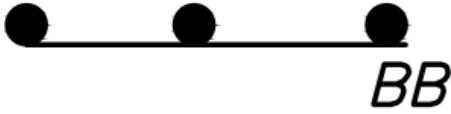
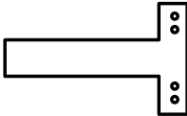

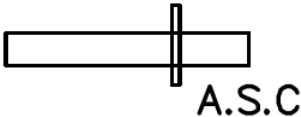

<b>Standard Symbols</b>	
	Stabilized Construction Entrance
	Stabilized Construction Entrance with Wash Rack
	Construction Debris Ground Cover
	Land Grading
<p>RECPS - * lb/ft<sup>2</sup> (* INCLUDE SHEAR STRESS)</p>	Rolled Erosion Control Products Slope/Channel Stabilization
	Silt Fence
	Super Silt Fence
	Filter Sock (designation FS-18 refers to 18-inch diameter filter sock)
	Organic Filter Berm A
	Organic Filter Berm B





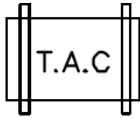

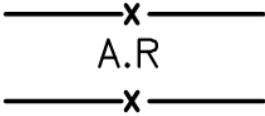
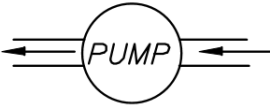
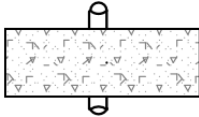
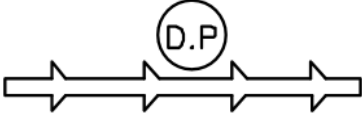

<b>Standard Symbols</b>	
	Straw Bale Dike
	Culvert Inlet Protection
	Standard Inlet Protection
	At-Grade Inlet Protection
	Curb Inlet Protection
	Median Inlet Protection
	Standard Inlet Guard
	Block and Gravel Inlet Protection
	Stone Check Dam
	Inlet Filter Bag (Curbed Roadway)
	Inlet Filter Bag (Roadway Swale or Channel)

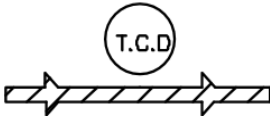

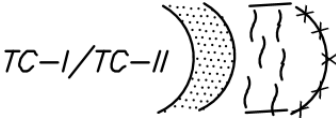
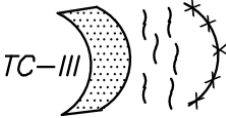
<b>Standard Symbols</b>	
	Silt Fence on Pavement
	Diversion Fence
PD/S-1 OR PD/S-2 	Dike/Swale
A-2      B-3 	Earth Dike
	Mountable Berm
A-2      B-3 	Temporary Swale
	Paved Flume
	Energy Dissipator
	Pipe Slope Drain (designation PSD-12 refers to 12-inch pipe slope drain)
	Rock Outlet Protection (Discharge to Semi-Confined Channel Section)
	Rock Outlet Protection (Discharge to Confined Channel Section)

<b>Standard Symbols</b>	
	Rock Outlet Protection (Discharge to Unconfined Channel or Flat Area)
	Plunge Pool
	Level Spreader
	Pipe Outlet Sediment Trap
	Stone Outlet Sediment Trap
	Baffle Board Sediment Basin
	Skimmer Sediment Basin
	Concentric Trash Rack and Anti-Vortex Device Sediment Basin
	Typical Anti-Seep Collars Sediment Basin
	Emergency Spillway Sediment Basin
	Removable Pumping Station

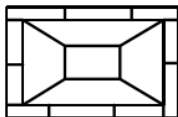
<b>Standard Symbols</b>	
 SP	Sump Pit
 PST	Portable Sediment Tank
 FB	Pumped Water Filter Bag
 T.A.C	Temporary Access Ford
 T.A.C	Temporary Access Culvert
 T.A.B	Temporary Access Bridge
 A.R	Access Roads
 PUMP	Pump Around Practice
	Culvert Pipe with Access Road
 D.P	Diversion Pipe
 S.P.D	Slotted Pipe Diversion

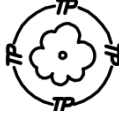
<b>Standard Symbols</b>	
	Temporary Channel Diversion
	Sandbag Channel Diversion
	Turbidity Curtain
	Turbidity Curtain
	Portable Dam/Barrier
	Portable Dam/Barrier
	Utility Crossing
	Dewatering Basin
	On-site Concrete Washout Structure
	Tree Protection; Tree Root Protection with Silt Fence

# Chapter 1 Introduction

## 1.1 Impacts of Erosion

Impacts of erosion and sedimentation from areas undergoing urban land development are well documented nationwide. Suspended solids from urban runoff and construction activities are implicated in each of the District of Columbia's total maximum daily loads and addressed in corresponding implementation plans. Through updated erosion and sediment control (ESC) regulations, inspections, and enforcement, the District intends to achieve 90% sediment load reductions to its streams. Effective ESC Plans are critical components to meeting this goal.

Beyond the environmental benefits to the District's waterways, erosion and sediment control prevents discharge of sediment into city streets and drainage systems. Sediment in streets can be a public safety issue, and sediment in a drainage system can result in lost conveyance capacity and shallow flooding. Dust from construction is also a nuisance and a concern for people with respiratory illnesses.

## 1.2 Principles of Erosion and Sediment Control

### 1.2.1 Factors that Influence Erosion

The Universal Soil Loss Equation (USDA, 2008) has been used to estimate soil erosion since the late 1970s (Wischmeier and Smith, 1978). While this model has been updated, the underlying factors that impact the amount of erosion remain the same: rainfall (or climate), soil, topography, and soil cover.

#### Rainfall

Rainfall intensity influences the rate of soil erosion and varies significantly in the District depending on the season. Monthly rainfall varies from about 2.5 inches in February (6.1% of annual rainfall) to 4.9 inches in August (almost 12% of annual rainfall). In addition, summer storms are typically much more intense, creating greater erosion potential. Regardless of the season, a single intense storm event can create a tremendous amount of erosion. A good ESC Plan will call for stabilizing the site as quickly as possible and ensuring that any cleared land drains to a sediment-capture practice.

#### Soil

Soil types differ in their erodibility, or potential to erode, and an Erodibility Index has been determined for most mapped soil types. Since many District areas are mapped as Urban Soils, which have highly variable soil characteristics, those soils need to be assessed on site in more detail. In general, sites with higher clay or organic content are less erodible. When an initial site investigation identifies highly erodible soils, the ESC Plan may call for enhanced erosion control measures.

Topography

The topography of the site (as measured by a “length-slope” factor) also influences the amount of erosion. In general, longer and steeper slopes result in greater erosion potential, particularly for gully or rill erosion. The District’s regulations and this manual advise minimizing erosion from steep slopes by avoiding clearing or creating these slopes where possible and by utilizing specialized erosion and sediment controls where steep sites are disturbed (see Section 1.3 and Chapters 2 and 4).

Cover and Management Factor

The cover and management factor reflects the potential for erosion based on the type of vegetation or other material placed over soil. Bare ground has far greater erosion potential than soil covered by mulch or grass at various densities (see Figure 1.1). As a result, construction sites have tremendous potential to generate erosion, which must be limited using temporary or permanent stabilization with grasses or mulch.

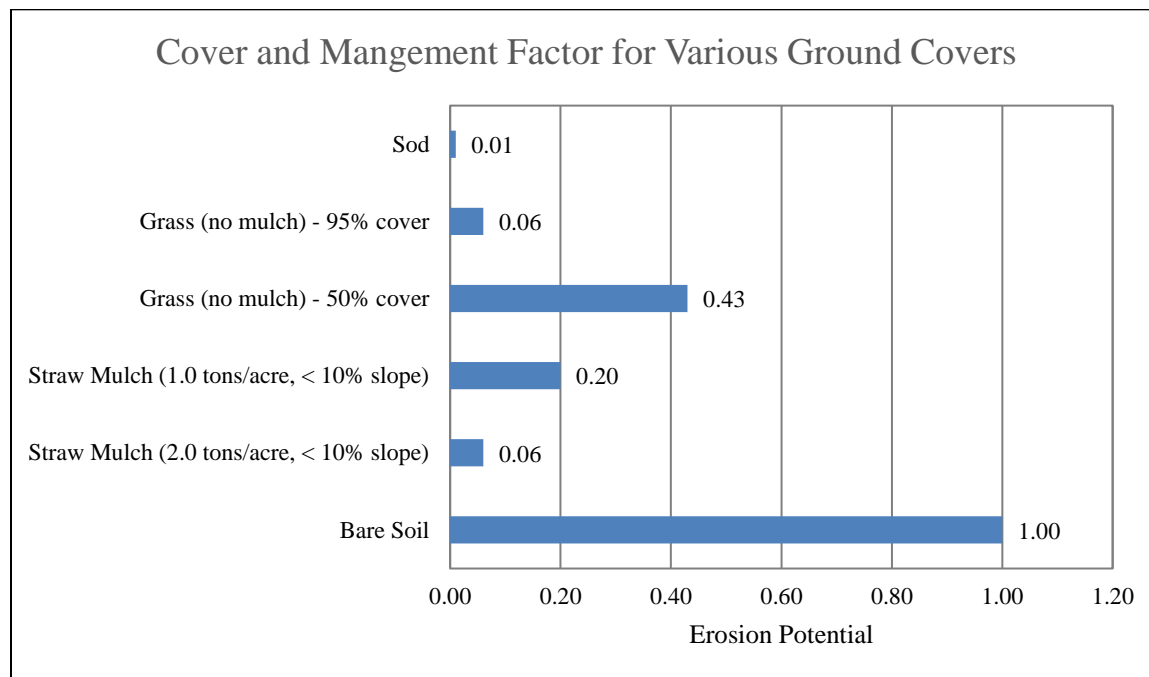

**Figure 1.1 Cover and management factors (Wischmeier and Smith, 1978).**

**1.2.2 Impacts of Land Development on Natural Resources**

Erosion and sedimentation during the construction process has severe impacts on natural resources such as natural habitats, wetlands, and other waterbodies. Sediments and suspended solids cause poor water clarity, loss of beneficial aquatic vegetation, and poor fish habitat in the Anacostia River Basin (MDE and DDOE, 2007). For waterbodies assessed in the 2014 District of Columbia Water Quality Report, total suspended solids were a cause of impairment in 33% of the miles of rivers and streams; 43% of the acres of lakes, reservoirs, and ponds; and 13.5% of the square miles of bays and estuaries (EPA, 2016).

### 1.2.3 Principles for an Effective Erosion and Sediment Control Plan

The following principles are the basis for creating an effective ESC Plan (adapted from CWP, 2000):

#### Minimize clearing and grading

Limiting the amount of clearing and grading reduces the area of bare soil that is exposed. Where site conditions allow, this is the most cost-effective method for reducing soil erosion. It is critical to clearly identify the limits of disturbance on the ESC Plan and to ensure that clearing limits are adhered to in the field.

#### Protect waterways and stabilize drainageways

Construction and the resulting sedimentation can severely impact natural waterways, which need to be protected by a buffer and sufficient sediment controls. Engineered drainageways, such as swales, have the potential to transport sediment if they are not properly designed. Use conveyance practices to divert clean water around disturbed areas and convey runoff with minimal erosion.

#### Phase construction to limit soil exposure

Site construction is often a long process. Plan construction activities in a sequence of phases that minimize the soil area exposed at one time and reduce the length of time between initial exposure and final grading.

#### Immediately stabilize exposed soils

Temporary erosion control measures, such as mulches and temporary grasses, can significantly reduce erosion at a site. Figure 1.1 shows that the erosion potential from bare ground is over 15 times greater than from ground with a heavy mulch cover (2 tons per acre) and 100 times greater than from established sod. Therefore, the construction sequencing plan needs to ensure soil is stabilized as soon as possible.

#### Protect steep slopes and cuts

Topography influences the amount of erosion, particularly for very steep slopes greater than 15%. Minimize the creation and disturbance of steep slopes where possible, or safely convey flows through or around them. According to the District's code (21 DCMR § 543.11), when land development occurs on steep slopes, the ESC Plan "shall be designed, signed, and sealed by a professional engineer, licensed in the District of Columbia, and the applicant shall incorporate additional protection strategies which the Department of Energy and Environment (DOEE) may require in order to prevent erosion or transportation of sediments from the site." The US Environmental Protection Agency's (EPA's) National Pollutant Discharge Elimination System (NPDES) General Permit for Construction Activities also requires minimizing disturbance of steep slopes.

#### Install perimeter controls

Prevent flow from leaving the site by installing silt fences or other barriers/filters at the site boundaries and other exit points, such as storm drains.

#### Employ advanced settling controls

When sediment traps and basins are used to control sediment, design features such as improved outlet devices or settling agents can greatly enhance effectiveness.

Table 1.1 indicates the sections of this manual that address each ESC principle.

**Table 1.1 Principles of Erosion and Sediment Control**

<b>Principle</b>	<b>Chapter or Section in this Manual</b>
Minimize clearing and grading	Section 2.5 Land Grading Section 9.3 Tree Protection and Preservation
Protect waterways and stabilize drainageways	Chapter 4 Conveyance Chapter 5 Water Control Chapter 8 Waterways and Stream Protection
Phase construction to limit soil exposure	Section 2.5 Land Grading Section 9.1 Dust Control
Immediately stabilize exposed soils	Chapter 2 Soil Stabilization
Protect steep slopes and cuts	Chapter 2 Soil Stabilization Chapter 4 Conveyance
Install perimeter controls	Chapter 3 Sediment Barriers and Filters
Employ advanced settling controls	Chapter 5 Water Control Chapter 6 Sediment Traps and Basins Chapter 7 Dewatering Section 9.4 Flocculants

### **1.3 The District's Erosion and Sediment Control Program**

The District's ESC program is regulated by Chapter 5 (Water Quality and Pollution) of Title 21 (Water and Sanitation) of the District of Columbia Municipal Regulations (DCMR), commonly called the Rule on Stormwater Management and Soil Erosion and Sediment Control (Stormwater Rule). This section provides a brief overview of the Stormwater Rule and key resources for compliance.

#### Applicability/Site Size and Disturbance

In the Stormwater Rule, specific elements of ESC and stormwater management are triggered by the type of activity and amount of land being disturbed, and for stormwater management, whether or not there are substantial improvements to buildings on the site regardless of the amount of land disturbed. Therefore, a given site may require stormwater management only, ESC only, or both (see Figure 1.2).

#### Exempt Activities

Some activities such as home gardening, installing a fence or deck, and emergency activities are exempt from the Stormwater Rule and may not require an ESC or Stormwater Plan. See 21 DCMR §§ 517 and 541.



### Area of Disturbance

The area of land disturbed is the primary driver of ESC Plan requirements. Except for exempt activities, any site with at least 50 square feet of land disturbance requires an ESC Plan. In addition to an ESC Plan, activities that disturb at least 5,000 square feet of land (i.e., major land-disturbing activities) are also required to have a Stormwater Management Plan, on-site pollution prevention measures, and a “responsible person” on site to address erosion control problems that arise during construction. Sites that disturb greater than one acre of land are regulated by EPA’s NPDES Construction General Permit and need to submit a Stormwater Pollution Prevention Plan (SWPPP) to both DOEE and EPA Region 3 that is compliant with the requirements of this permit. A SWPPP is a document that identifies potential sources of stormwater pollution at a construction site, describes practices to reduce pollutants in stormwater discharge from the site, and may identify procedures to achieve compliance. More information on SWPPPs can be found in the 2017 EPA Construction General Permit, Chapter 7

([https://www.epa.gov/sites/production/files/2017-06/documents/2017\\_cgp\\_final\\_permit\\_508.pdf](https://www.epa.gov/sites/production/files/2017-06/documents/2017_cgp_final_permit_508.pdf)) and on EPA’s website on developing a SWPPP (<https://www.epa.gov/npdes/developing-stormwater-pollution-prevention-plan-swPPP>).

### Major Substantial Improvement

Sites that improve existing structures must provide a Stormwater Management Plan if the combined footprint of the improvement and associated land disturbance is at least 5,000 square feet and if the cost of construction is at least 50% of the preproject value of the structure (i.e., a major substantial improvement activity). It is possible that some major substantial improvement sites can be required to provide a Stormwater Management Plan but not be required to provide an ESC Plan.

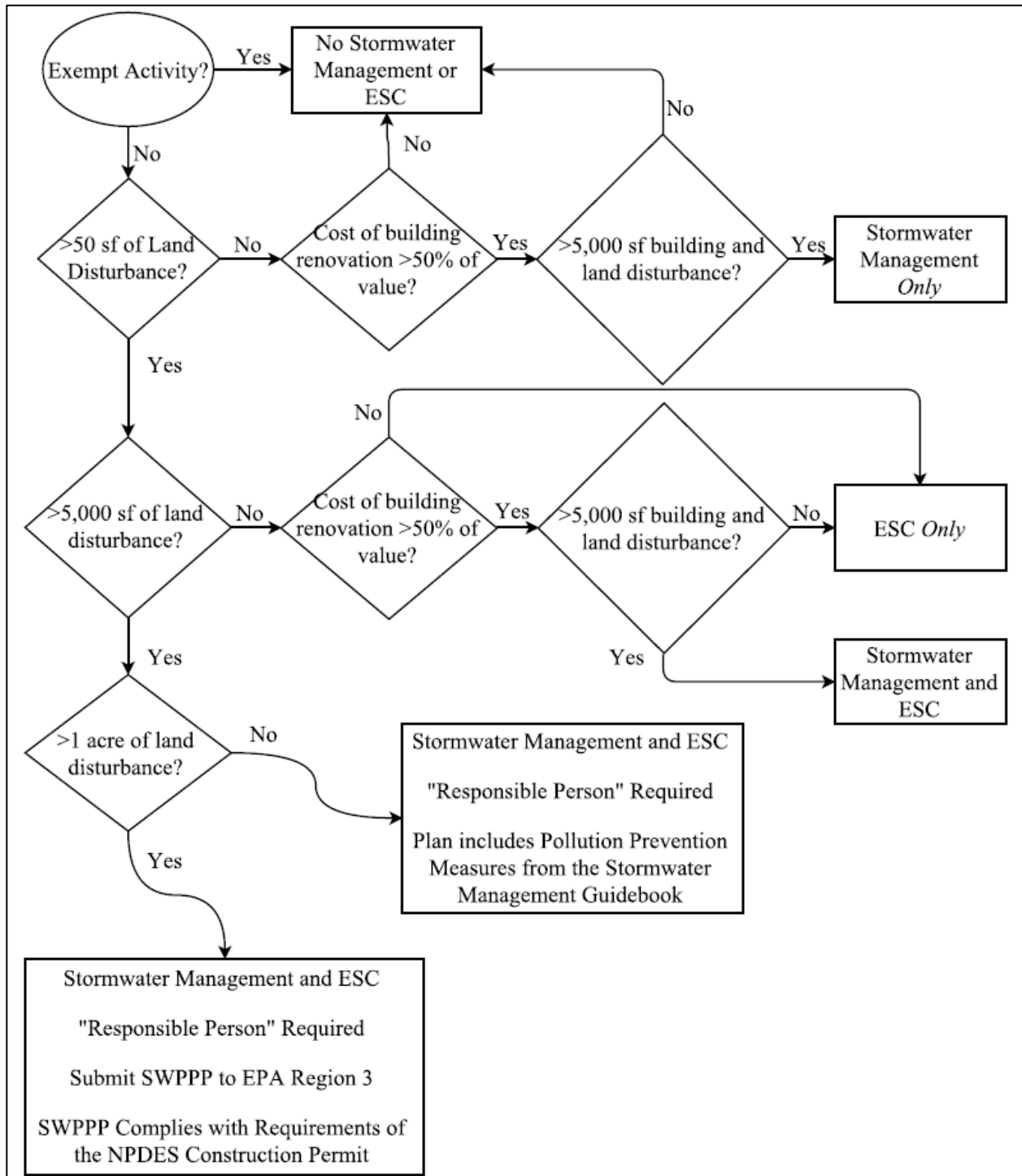

**Figure 1.2** Flowchart for determining ESC and stormwater management requirements in the District.

Plan Review Fees and Submissions

Applicants submit ESC Plans to the Department of Consumer and Regulatory Affairs (DCRA), which assigns the ESC Plans to DOEE for review. DOEE must approve the ESC Plan in order

for the applicant to receive a building permit within the District. ESC Plan review fees are adjusted for inflation annually and updated in the *DC Register*. These fees are based on the area of land disturbed, as well as the volume of excavation and fill. The initial fees are paid at the time the applicant files for a building permit, and other fees are paid before the building permit is granted. Current fee rates are available at <https://doee.dc.gov/esc>.

### ESC Plan Requirements

ESC Plan requirements are specified in 21 DCMR §§ 540–547. They provide a framework to obtain a permit for land disturbance within the District and design specifications for erosion and sediment control in projects that are regulated by the Stormwater Rule. The DOEE website <https://doee.dc.gov/esc> includes a comprehensive plan review checklist, and Table 1.2 includes a summary of ESC plan requirements.

**Table 1.2 The District’s ESC Plan Requirements**

Plan Element	Requirements
Natural Resources/Soils Inventory	<ul style="list-style-type: none"> <li>• Identify existing natural features such as vegetation, wildlife habitat, and waterways, and discuss these features in the ESC Plan notes.</li> <li>• Describe soil types and identify unstable soils.</li> <li>• Include existing site topography.</li> <li>• Identify conditions around site surface water discharge points.</li> </ul>
Special Measures for Steep Slopes and Unstable Soils	<ul style="list-style-type: none"> <li>• Avoid working on steep slopes.</li> <li>• Identify unstable soils and steep slopes (&gt;15%) in both pre-and post-development conditions.</li> <li>• Provide a P.E. seal for any work on steep or unstable soils.</li> </ul>
Construction Sequencing Plan	<ul style="list-style-type: none"> <li>• Provide a detailed construction sequence that ensures minimum timeframes are adhered to (see Table 1.3).</li> </ul>
Grading Plan	<ul style="list-style-type: none"> <li>• Identify the limits of disturbance (LOD) and the surface area within those limits.</li> <li>• Include a project narrative that specifies how the project will ensure land disturbance does not extend beyond the proposed LOD.</li> </ul>
Conveyance and Sediment Capture Devices	<ul style="list-style-type: none"> <li>• Ensure storm flows are routed through areas with ESC measures to an approved point of discharge.</li> </ul>
Site Stabilization Plan	<ul style="list-style-type: none"> <li>• Identify interim and permanent stabilization measures.</li> <li>• Stabilize paved areas permanently with crushed stone or other approved measures.</li> </ul>
Waterways Provisions	<ul style="list-style-type: none"> <li>• Identify waterway crossing and stream bank protection measures.</li> <li>• Ensure these measures are consistent with the standards and specifications for ESC.</li> </ul>

Plan Element	Requirements
Roadways and Utilities	<ul style="list-style-type: none"> <li>• Include interceptor dikes and flumes to control runoff from roadway grading and outlet to an approved drainage structure.</li> <li>• Ensure utility trenching is stabilized daily and less than 500 linear feet is open at any one time.</li> </ul>
Stockpiling	<ul style="list-style-type: none"> <li>• Include perimeter controls around stockpile areas.</li> <li>• Stabilize stockpile areas.</li> </ul>
Excavation and Dewatering	<ul style="list-style-type: none"> <li>• Identify the volume of spoil material (excavation) and the volume of borrow material (fill) based on the disturbance and grading plan.</li> <li>• Filter water prior to discharging to the storm sewer system.</li> </ul>
Pollution Prevention	<ul style="list-style-type: none"> <li>• If a site’s land disturbance is 5,000 square feet or more, include a Stormwater Pollution Prevention Plan composed of “good housekeeping notes.”</li> <li>• For application of fertilizer to turf, comply with the “Anacostia River Clean Up and Fertilizer Protection Act of 2012.”</li> </ul>

Note: For more detailed information, consult the DOEE website, which includes a more detailed plan review checklist. This table does not include many administrative elements such as the name of the property owner, layout of the plans, etc.

**Table 1.3 Timelines in the Stormwater Rule**

Construction Element	Timeline
Permanent or Temporary Stabilization: Slopes Steeper than 3:1	7 days from last disturbance
Permanent or Temporary Stabilization: Other Slopes	14 days from last disturbance
ESC Measures in Place	Before land disturbance; until after land is stabilized
Temporary Stabilization of Stockpile Areas	15 days from last use or addition

Inspections and Meetings during Construction

DOEE inspectors are authorized to conduct on-site inspections of all stormwater management facilities constructed in the District of Columbia to ensure compliance with the approved plans. Inspections are performed at different stages as specified in the sequence of construction. The first step is a preconstruction meeting to discuss the inspection schedule and requirements (see Table 1.4).

At least 72 hours (three business days) before construction begins, the site owner or contractor is responsible for contacting DOEE’s Inspection and Enforcement Division to schedule a preconstruction meeting. The owner or contractor must also schedule a final inspection within two weeks after completing construction of the BMP(s). The registered professional engineer with responsibility to certify the As-Built Plan is required to submit the As-Built Plan for the

stormwater management BMP(s) to DOEE within 21 days after final inspection. DCRA will not issue a Certificate of Occupancy Permit unless the Stormwater Management Plan for the site has been implemented for on-site stormwater management and any required off-site retention.

**Table 1.4 Inspections during Construction**

<b>Inspection Type</b>	<b>When Required</b>	<b>When to Notify DOEE</b>
Preconstruction	Before land disturbance	3 business days before any land disturbing activity begins
Pre-BMP construction	Before construction of a stormwater BMP	3 business days before BMP construction begins
Other phase of construction	As indicated on the plan, or per DOEE request either during the preconstruction meeting or during regular construction inspections	3 business days before inspection
Completion of land disturbing activity	At the completion and stabilization of a land-disturbing activity	Within 2 weeks of completing the activity
Final BMP inspection	After a permanent stormwater BMP is constructed	1 week before completing BMP construction
Final construction inspection	Once the site is entirely stabilized and all permanent practices are in place	1 week before inspection and within 4 weeks of completing site construction
As-Built Plan submission	After final site inspection	Within 21 days of final construction inspection

### Responsible Person

The Stormwater Rule requires that a “responsible person” is present on-site or available at sites that disturb a minimum of 5,000 square feet of land (i.e., major land-disturbing activities). The responsible person will inspect each site at least once biweekly and after every storm event, and will respond to potential or actual ESC problems identified by construction personnel. The responsible person must also be available to discuss solutions to these problems with DOEE inspectors.

The responsible person must be licensed in the District of Columbia as a civil or geotechnical engineer, land surveyor, or architect. Alternatively, the responsible person can be certified through a District-approved training program. Consult the DOEE website for a list of approved courses.

### Plan Changes during Construction

Because of the dynamic nature of site construction and the unpredictability of extreme rainfall events, the ESC Plan often needs to be changed during construction. These changes can be initiated by a DOEE inspector or by a responsible person on-site. DOEE can require a change to the plan at any phase of construction, including changing ESC practices or adding or removing specified site visits.

The regulated person (i.e., the developer, owner, or their agent) may submit a revised ESC plan to DOEE to request a change. The regulated person must receive DOEE’s approval of a plan revision prior to implementing any changes, including changes that affect a site’s compliance or that may result in discharge of additional pollutants to the District’s waters. DOEE may make an on-site determination regarding approval of plan changes.

### 1.4 NPDES Construction General Permit and Stormwater Pollution Prevention Plan

In the District of Columbia, EPA has jurisdiction over the NPDES Construction General Permit, which regulates all activities that have more than one acre of land disturbance alone or as part of a common plan of development. Developers of sites regulated by this permit must submit a Notice of Intent (NOI) and an SWPPP to the EPA Region 3 office. The developer must also submit a copy of the SWPPP to DOEE.

### 1.5 Erosion and Sediment Control Principles for the Urban Environment

While core ESC principles are the same regardless of the development setting, the District of Columbia is unique when compared with the urban character of existing and new development in neighboring states. To begin with, the District is much more intensely developed than the urbanized areas of Maryland and Virginia. In 2010, the District’s impervious cover was estimated at 39% (Comey et al., 2010), while the 2012 estimates for Maryland and Virginia were 19% and 16%, respectively (Nowak and Greenfield, 2012). The data for new development show an even starker contrast. For example, new housing units built in 2014 were dominated by multiple family structures (> 5 units/building) in the District, while single family homes represented the bulk of new construction in Maryland and Virginia (U.S. Census, 2016; see Figure 1.3).

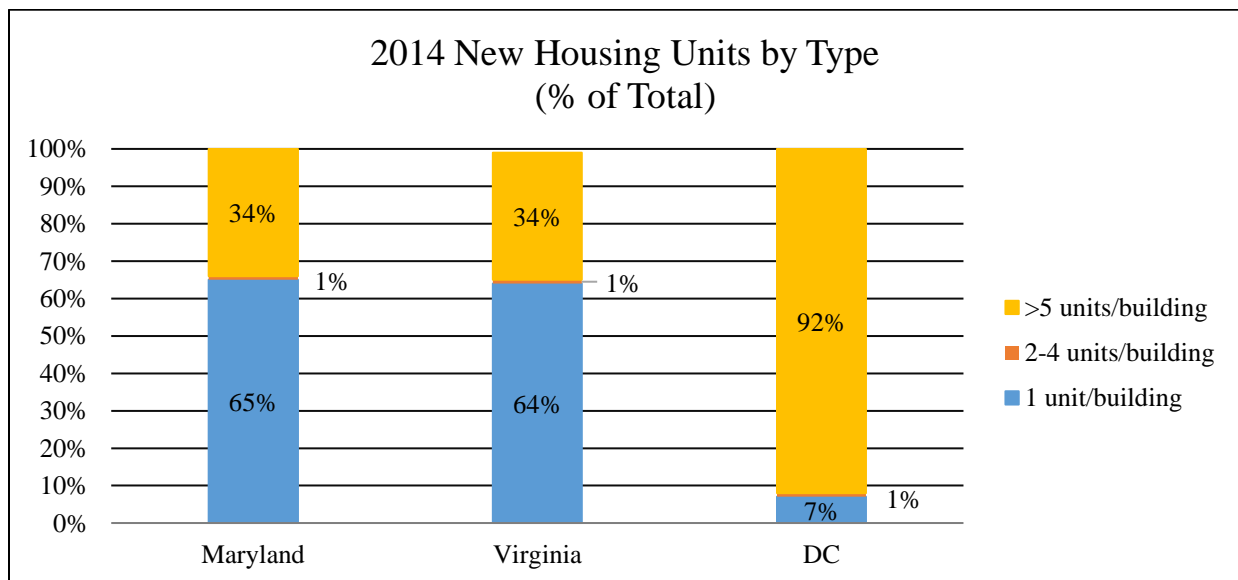

Figure 1.3 New DC, Maryland, and Virginia housing units in 2014.

The characteristics of the District's highly urbanized development create both opportunities and challenges in developing effective ESC Plans and determine which practices and methods are the most effective at reducing erosion and preventing eroded sediment from leaving a site. This section and Table 1.5 describe these characteristics and related design considerations.

### Urban Soils

Most land development sites within the District have been developed previously and are dominated by urban soils, which have unpredictable soil properties and may be contaminated from previous industrial uses. For sites where dewatering is needed, stormwater that had contact with contaminated soils needs to be filtered to meet discharge standards (see the note in Section 3 Conditions Where Practice Applies in Chapter 7 Dewatering).

### Redevelopment Sites

The demolition phase is important for redevelopment sites and materials recovered during demolition can be used for temporary stabilization (see Section 2.4 Construction Debris Ground Cover). When undertaking large-scale redevelopment projects, construction phasing for ESC often needs to consider complex issues related to maintaining access to businesses, residences, and services within the redevelopment area.

### Highly Urbanized Surrounding Areas

In addition to redevelopment, much of the new development in the District occurs as infill. Consequently, the ESC Plan needs to consider the surrounding areas in detail. First, sediment tracking onto roadways can be a major issue in these environments and needs to be managed with an effective construction entrance (see Section 2.1 Stabilized Construction Entrance) and possibly with daily or even more frequent street sweeping. Second, the plan for movement in and out of the site needs to consider the larger neighborhood setting, and this planning may impact the sequencing identified in the ESC Plan.

### Small Sites

In the urban environment, construction sites are on average much smaller than in suburban or rural areas, due to both the cost of land and the limited availability of large areas that are available for development. For large-scale development sites, a greater land area is exposed during construction, and construction phasing can become complicated in an effort to limit the amount of land exposed at any one time. However, small sites also present unique challenges, such as lack of space for stockpile areas or to locate sediment trapping devices (e.g., sediment basins and traps). As a result, the ESC Plan will often need to identify an off-site area for storing stockpiled topsoil and other materials. Small sites rely more heavily on perimeter controls, such as silt fence, and may need to incorporate other practices, such as sediment tanks.

Depending on the site configuration and proposed project, grading a small site can also be problematic. Although land development on or creation of steep slopes is discouraged, these slopes may be difficult to avoid on some sites in the District.

### Lot Line Development

While building codes in suburban areas typically require setbacks, land development in the District may extend to the edge of the property line. This configuration can make it difficult to site perimeter practices because the paved landscape will often extend to the location where the practices are sited. As a result, ESC Plans in the urban landscape need to rely on more durable sediment barriers such as super silt fence (see Section 3.2) or products such as filter socks (see Section 3.3), which can be used adjacent to or on top of paved areas. The plan also needs an explicit sequence that ensures these practices remain in place until the site is entirely stabilized.

### Large Building Footprint

While suburban developments typically incorporate surface parking and turf into site design, the density of development in the District's urban landscape favors maximizing the building footprint. ESC Plans in the District have an initial construction phase focused on excavating the building foundation, including dewatering (Chapter 7) and a plan for safe disposal and possible reuse of excavated soils.

### Permanent Stormwater BMPs

The suite of stormwater BMPs used during development in the District is slightly different than in surrounding jurisdictions. Due to space and site layout constraints and relatively strict requirements for runoff reduction, development projects in the District do not often rely on practices such as ponds and wetlands that capture runoff from large areas. Instead, there is a greater reliance on "zero space consumption" practices such as green roofs, permeable pavements, rainwater harvesting, and underground filtering systems. Consequently, there is little opportunity in this setting to convert temporary practices (such as sediment traps and basins) into permanent stormwater BMPs. In addition, some of these smaller scale practices (particularly permeable pavements) need to be protected during the construction phase to ensure they do not become clogged with eroded sediment.



**Table 1.5 Special ESC Design Considerations in the District’s Urban Environment**

<b>Urban Environment</b>	<b>Special Design Considerations</b>	<b>Useful Practices</b>
Urban Soils	<ul style="list-style-type: none"> <li>Contaminated soils and groundwater may be an issue</li> </ul>	<ul style="list-style-type: none"> <li>Chapter 7 Dewatering</li> </ul>
Redevelopment Sites	<ul style="list-style-type: none"> <li>Complicated construction phasing</li> <li>Use of construction debris as a temporary ground cover</li> </ul>	<ul style="list-style-type: none"> <li>Section 2.4 Debris Ground Cover</li> </ul>
Highly Urbanized Surrounding Areas	<ul style="list-style-type: none"> <li>Sediment tracking onto roadways is a major issue</li> <li>Sequence needs to consider activities outside the site</li> <li>“Microscale” resource protection such as individual street trees</li> </ul>	<ul style="list-style-type: none"> <li>Section 2.1 Stabilized Construction Entrance</li> <li>Section 9.1 Dust Control</li> <li>Section 9.3 Tree Protection and Preservation</li> </ul>
Small Sites	<ul style="list-style-type: none"> <li>Few areas for stockpiling materials and topsoil</li> <li>Greater reliance on sediment barriers and filters</li> <li>Steep cuts may be needed to fit the planned development project within the available space</li> </ul>	<ul style="list-style-type: none"> <li>Chapter 2 Site Stabilization</li> <li>Chapter 3 Sediment Barriers and Filters</li> <li>Section 7.3 Portable Sediment Tank</li> </ul>
Lot Line Development	<ul style="list-style-type: none"> <li>Use of durable sediment barriers</li> </ul>	<ul style="list-style-type: none"> <li>Chapter 3 Sediment Barriers and Filters</li> </ul>
Large Building Footprint	<ul style="list-style-type: none"> <li>Dewatering is critical during the excavation phase</li> <li>Need to identify a plan for proper disposal of excavated sediment</li> </ul>	<ul style="list-style-type: none"> <li>Chapter 7 Dewatering Practices</li> </ul>
Permanent Stormwater BMPs	<ul style="list-style-type: none"> <li>Few opportunities to convert from temporary ESC practices to permanent stormwater BMPs</li> <li>Greater need to stabilize the site completely before installing permanent stormwater BMPs</li> </ul>	<ul style="list-style-type: none"> <li>Chapter 2 Site Stabilization</li> <li>Chapter 3 Sediment Barriers and Filters</li> </ul>



## Chapter 2 Soil Stabilization

### 2.1 Stabilized Construction Entrance

#### 2.1.1 Definition

A stabilized construction entrance (SCE) is a temporary pad of aggregate with a geotextile underliner located where vehicles enter or leave a construction site.

#### 2.1.2 Purpose

Stabilized construction entrances reduce the amount of sediment transported onto streets or public rights-of-way by vehicles exiting the construction site.

#### 2.1.3 Conditions Where Practice Applies

Locate stabilized construction entrances at points where construction vehicles enter and exit the site.

#### 2.1.4 Design Criteria

##### Length

A minimum of 50 feet (30 feet for a single-family residence lot).

##### Width

A minimum of 10 feet and flared at the existing road to provide a turning radius.

##### Geotextile

Place nonwoven Geotextile Class SE over the existing ground prior to placing stone.

##### Stone

Place crushed aggregate 2 inches to 3 inches in size (see Appendix A, Table A.2), or recycled concrete equivalent (without rebar) at least 6 inches deep over the length and width of the entrance.

##### Surface Water

Pipe all surface water flowing to or diverted toward construction entrances under the entrance to maintain positive drainage. Protect pipe installed under the SCE with a mountable berm. Size the pipe with a minimum diameter of 6 inches to convey the 2-year, 24-hour storm. A pipe is not necessary when the SCE is located at a high spot and conveys no drainage.

### Location

Locate a stabilized construction entrance at every point where construction traffic enters or leaves a construction site. Vehicles leaving the site must travel over the entire length of the stabilized construction entrance. Where possible, locate construction entrances at the high side of the project area. Where the stabilized construction entrance creates an opening in perimeter silt fence, securely tie the silt fence into the mountable berm at its centerline to provide a continuous barrier.

#### **2.1.5 Construction Specifications**

1. Place the stabilized construction entrance in accordance with the approved plan. Vehicles must travel over the entire length of the SCE. Use a minimum length of 50 feet (30 feet for single-family residence lot) and a minimum width of 10 feet. Flare the SCE at the existing road to provide a turning radius.
2. Pipe all surface water flowing to or diverted toward the SCE under the entrance maintaining positive drainage. Provide pipe as specified on approved plan. Protect pipe installed through the SCE with a mountable berm with 5:1 slopes and a minimum of 12 inches of stone over the pipe. When the SCE is located at a high spot and has no drainage to convey, a pipe is not necessary. A mountable berm is required when the SCE is not located at a high spot.
3. Prepare subgrade and place nonwoven geotextile.
4. Place crushed aggregate (2 inches to 3 inches in size) or equivalent recycled concrete (without rebar) at least 6 inches deep over the length and width of the SCE.

#### **2.1.6 Maintenance**

Maintain the SCE in a condition that will minimize tracking of sediment onto public rights-of-way. This may require adding stone or other repairs as conditions demand. All sediment spilled, dropped, or tracked onto public rights-of-way must be removed immediately by vacuuming, sweeping, or scraping. Washing the roadway to remove mud tracked onto pavement is not acceptable unless wash water is directed to an approved sediment control practice. Daily inspection and maintenance is required.

Remove sediment from vehicle wheels before driving onto public rights-of-way. When washing is required, it must be done on an area stabilized with stone that drains into an approved sediment-trapping device (see Section 2.2 Stabilized Construction Entrance with Wash Rack).

After construction is complete and the site is stabilized, remove the SCE and stabilize the subsequent area, unless it will be used as an underlayment for a driveway.

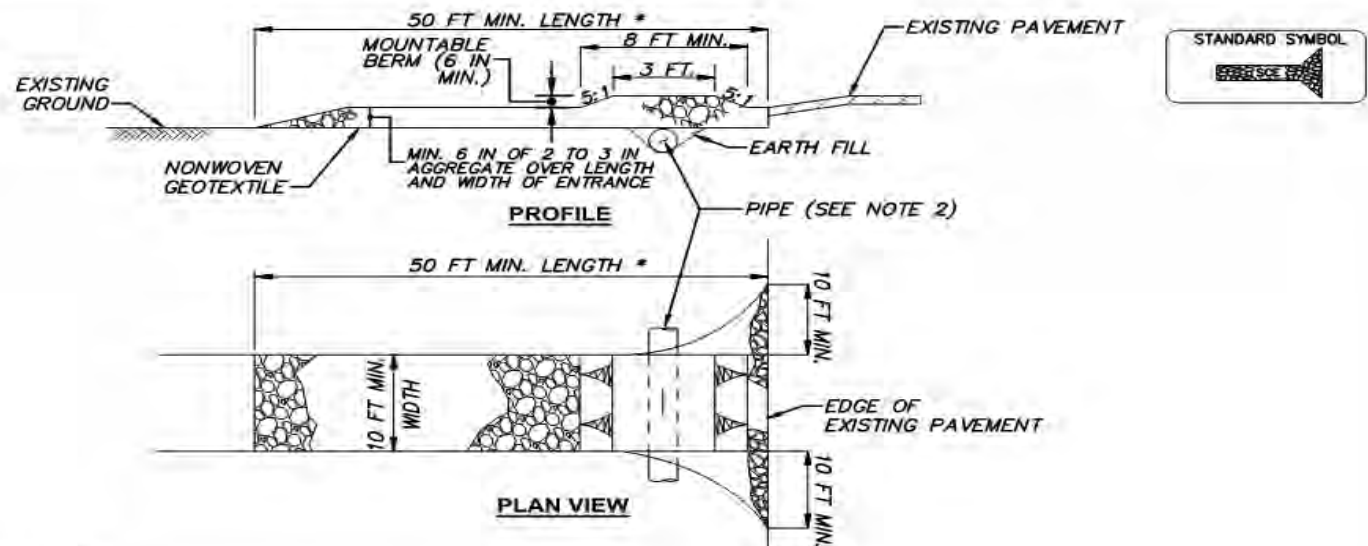

#### CONSTRUCTION SPECIFICATIONS

1. PLACE THE STABILIZED CONSTRUCTION ENTRANCE IN ACCORDANCE WITH THE APPROVED PLAN. VEHICLES MUST TRAVEL OVER THE ENTIRE LENGTH OF THE SCE. USE A MINIMUM LENGTH OF 50 FEET (\*30 FEET FOR SINGLE-FAMILY RESIDENCE LOT) AND A MINIMUM WIDTH OF 10 FEET. FLARE THE SCE AT THE EXISTING ROAD TO PROVIDE A TURNING RADIUS.
2. PIPE ALL SURFACE WATER FLOWING TO OR DIVERTED TOWARD THE SCE UNDER THE ENTRANCE MAINTAINING POSITIVE DRAINAGE. PROVIDE PIPE AS SPECIFIED ON APPROVED PLAN. PROVIDE PIPE INSTALLED THROUGH THE SCE WITH A MOUNTABLE BERM WITH 5:1 SLOPES AND A MINIMUM OF 12 INCHES OF STONE OVER THE PIPE. WHEN THE SCE IS LOCATED AT A HIGH SPOT AND HAS NO DRAINAGE TO CONVEY, A PIPE IS NOT NECESSARY. A MOUNTABLE BERM IS REQUIRED WHEN THE SCE IS NOT LOCATED AT A HIGH SPOT.
3. PREPARE SUBGRADE AND PLACE NONWOVEN GEOTEXTILE.
4. PLACE CRUSHED AGGREGATE (2 TO 3 INCHES IN SIZE) OR EQUIVALENT RECYCLED CONCRETE (WITHOUT REBAR) AT LEAST 6 INCHES DEEP OVER THE LENGTH AND WIDTH OF THE SCE.
5. MAINTAIN ENTRANCE IN A CONDITION THAT MINIMIZES TRACKING OF SEDIMENT, ADD STONE OR MAKE OTHER REPAIRS AS CONDITIONS DEMAND TO MAINTAIN CLEAN SURFACE, MOUNTABLE BERM, AND SPECIFIED DIMENSIONS. IMMEDIATELY REMOVE STONE AND/OR SEDIMENT SPILLED, DROPPED, OR TRACKED ONTO ADJACENT ROADWAY BY VACUUMING, SCRAPING, AND/OR SWEEPING. WASHING ROADWAY TO REMOVE MUD TRACKED ONTO PAVEMENT IS NOT ACCEPTABLE UNLESS WASH WATER IS DIRECTED TO AN APPROVED SEDIMENT CONTROL PRACTICE.

DATE	APPR	
REVISED		
ISSUED:		
	REFERENCE	

### STABILIZED CONSTRUCTION ENTRANCE

★ ★ ★ DISTRICT OF COLUMBIA  
DEPARTMENT OF ENERGY &  
ENVIRONMENT

DWG. NO 201.1

SOURCE: 2011 MARYLAND STANDARDS & SPECIFICATIONS

Detail 1 – 201.1 Stabilized Construction Entrance

## **2.2 Stabilized Construction Entrance with Wash Rack**

### **2.2.1 Definition**

A stabilized construction entrance (SCE) with wash rack is a temporary pad of aggregate with a geotextile underliner that is enhanced using a wash rack embedded in the SCE and located where vehicles enter or leave a construction site.

### **2.2.2 Purpose**

To reduce the amount of sediment transported onto streets or public rights-of-way by vehicles exiting the construction site.

### **2.2.3 Conditions Where Practice Applies**

Consider using stabilized construction entrances with wash racks wherever soil and/or traffic conditions on site require washing the construction vehicle wheels prior to exiting the site to avoid excessive tracking of mud and dirt onto a roadway.

### **2.2.4 Design Criteria**

#### Length

A minimum of 50 feet (30 feet for a single-family residence lot).

#### Width

A minimum of 10 feet and flared at the existing road to provide a turning radius.

#### Geotextile

Place nonwoven Geotextile Class SE over the existing ground prior to placing stone.

#### Stone

Place crushed aggregate 2 inches to 3 inches in size (see Appendix A, Table A.2) or recycled concrete equivalent (without rebar) at least 6 inches deep over the length and width of the entrance.

#### Surface Water

Pipe all surface water flowing to or diverted toward construction entrances under the entrance to maintain positive drainage. Protect the pipe installed under the SCE with a mountable berm. Size the pipe with a minimum diameter of 6 inches to convey the 2-year, 24-hour storm. A pipe will not be necessary when the SCE is located at a high spot and conveys no drainage.

#### Location

Locate a stabilized construction entrance at every point where construction traffic enters or leaves a construction site. Vehicles leaving the site must travel over the entire length of the stabilized construction entrance. Where possible, locate construction entrances at the high side of

the project area. Where the stabilized construction entrance creates an opening in the perimeter silt fence, securely tie the silt fence into the mountable berm at its centerline to provide a continuous barrier.

### Wash Rack

Design the wash rack to withstand anticipated traffic loads and construct with reinforced concrete or metal. The wash rack must have minimum dimensions of 6 feet by 10 feet. Line approaches to the wash rack with 2 inches to 3 inches of crushed aggregate rock (see Appendix A, Table A.2) a minimum of 25 feet on both sides. Discharge the wash rack to a sediment removal BMP, such as a vegetated filter strip, or into a channel leading to a sediment removal device, such as a sediment trap or sediment tank.

### **2.2.5 Construction Specifications**

1. Use a wash rack designed and constructed/manufactured for the anticipated traffic loads. Concrete, steel, or other materials are acceptable. Prefabricated units such as cattle guards are acceptable. Use a minimum dimension of 6 feet by 10 feet. Orient the direction of ribs as shown on the detail. Approaches to the wash rack should be a minimum of 25 feet on both sides.
2. Install prior to, alongside of, or as part of the SCE.
3. Direct wash water to an approved sediment trapping device.

### **2.2.6 Maintenance**

Maintain the entrance in a condition that will minimize tracking of sediment onto public rights-of-way. Maintain stabilized construction entrances with wash racks to the specified dimensions by adding rock when necessary at the end of each workday. Maintain a stockpile of rock material on site for this purpose. Repair damaged wash racks as necessary to maintain their effectiveness.

Immediately remove all sediment spilled, dropped, or tracked onto public rights-of-way by vacuuming, sweeping, scraping, and/or sweeping. Washing roadway to remove mud tracked onto pavement is not acceptable unless wash water is directed to an approved sediment control practice. A stabilized construction entrance without a wash rack is shown in Section 2.1 Stabilized Construction Entrance.

After construction is complete and the site is stabilized, remove the SCE and stabilize the subsequent area unless it will be used as an underlayment for a driveway.

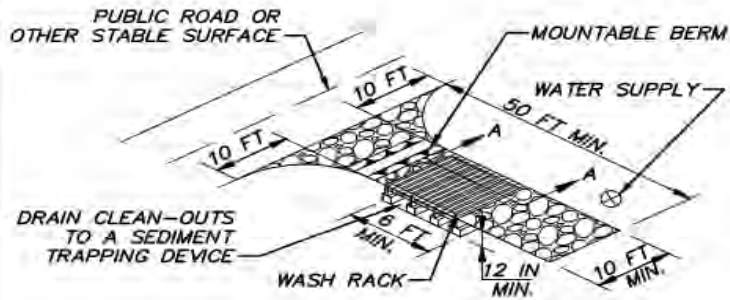

**ISOMETRIC VIEW - WASH RACK IN SCE**

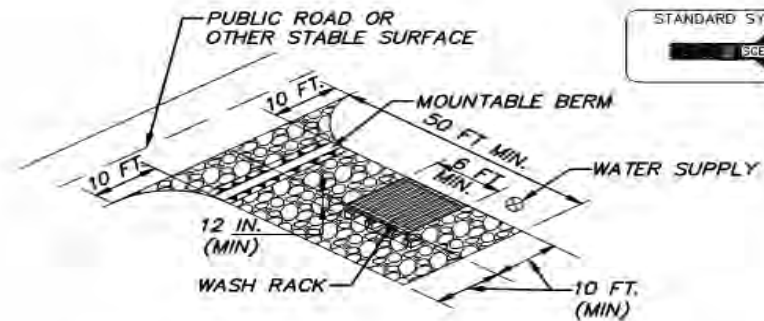

**ISOMETRIC VIEW - WASH RACK ALONG SCE**

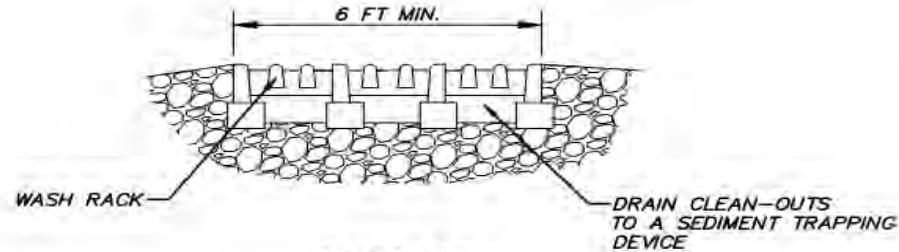

**SECTION A-A**

**CONSTRUCTION SPECIFICATIONS**

1. USE A WASH RACK DESIGNED AND CONSTRUCTED/MANUFACTURED FOR THE ANTICIPATED TRAFFIC LOADS. CONCRETE, STEEL, OR OTHER MATERIALS ARE ACCEPTABLE. PRE-FABRICATED UNITS SUCH AS CATTLE GUARDS ARE ACCEPTABLE. USE MINIMUM DIMENSION OF 6 FEET x 10 FEET. ORIENT DIRECTION OF RIBS AS SHOWN ON THE DETAIL. APPROACHES TO THE WASH RACK SHOULD BE A MINIMUM OF 25 FEET ON BOTH SIDES.
2. INSTALL PRIOR TO, ALONG SIDE OF, OR AS PART OF THE SCE.
3. DIRECT WASH WATER TO AN APPROVED SEDIMENT TRAPPING DEVICE.
4. KEEP AREA UNDER WASH RACK FREE OF ACCUMULATED SEDIMENT. IF DAMAGED, REPAIR OR REPLACE WASH RACK.

DATE	APPR	
REVISED		
ISSUED:		
	REFERENCE	

**STABILIZED CONSTRUCTION  
ENTRANCE WITH WASH RACK**



DISTRICT OF COLUMBIA  
DEPARTMENT OF ENERGY &  
ENVIRONMENT

DWG. NO 202.1

SOURCE: FULL MARYLAND STANDARDS & SPECIFICATIONS



## **2.3 Construction Road Stabilization**

### **2.3.1 Definition**

The temporary stabilization of access roads, haul roads, temporary construction parking areas, and other on-site vehicle transportation routes with stone immediately after grading.

### **2.3.2 Purpose**

To reduce the erosion of temporary roadbeds by construction traffic during wet weather. It also reduces the erosion and subsequent regrading of permanent roadbeds between the time of initial grading and final stabilization.

### **2.3.3 Conditions Where Practice Applies**

Wherever stone-base roads or parking areas are constructed, whether permanent or temporary, for use by construction traffic.

### **2.3.4 Design Criteria**

Areas that are graded for construction vehicle transport and parking purposes are especially susceptible to erosion. The exposed soil surface is continually disturbed, leaving no opportunity for vegetative stabilization. Such areas also tend to collect and transport runoff along their surfaces. During wet weather, they often become muddy and generate significant quantities of sediment that may pollute nearby streams or be transported off site on the wheels of construction vehicles. Dirt roads can become so unstable during wet weather that they are virtually unusable.

Pave permanent roads and parking areas as soon as possible after grading. However, weather conditions or the potential for damage may not make paving feasible in the early phases of a development project. As an alternative, the early application of stone may solve potential erosion and stability problems and eliminate later regrading costs. Some of the stone may also remain in place for use as part of the final base course in the construction of the road.

### **2.3.5 Construction Specifications**

#### Temporary Access Roads and Parking Areas

1. Temporary roads must follow the contour of the natural terrain to the extent possible. Slopes should not exceed 10%.
2. Locate temporary parking areas on naturally flat areas to minimize grading. Grades should be sufficient to provide drainage without causing erosion.
3. Roadbeds must be at least 14 feet wide for one-way traffic and 20 feet wide for two-way traffic.
4. All cuts and fills must be 2:1 or flatter to the extent possible.
5. Drainage considerations are as follows:

- (a) Provide drainage ditches as needed and design and construct in accordance with Section 4.4 Temporary Swales.
  - (b) Provide surface drainage to channel water to an approved location without causing surface erosion.
  - (c) Where water ponds on the surface, use subsurface drains to drain the site and convey this water to an approved location.
6. Clear the roadbed or parking surface of all vegetation, roots, and other objectionable material.
  7. Immediately apply a 6-inch course of 2-inch to 3-inch coarse aggregate after grading or completing utility installation within the right-of-way (see Appendix A, Table A.2). Geotextile fabric may be applied to the roadbed for additional stability.

#### Permanent Roads and Parking Areas

Design and construct permanent roads and parking areas in accordance with applicable DDOT criteria.

#### Vegetation

Stabilize all roadside ditches, cuts, fills, and disturbed areas adjacent to parking areas and roads with appropriate temporary or permanent vegetation according to Section 2.10 Vegetative Stabilization.

#### **2.3.6 Maintenance**

Both temporary and permanent roads and parking areas may require periodic top dressing with new gravel. Periodically check seeded areas adjacent to the roads and parking areas to ensure that a vigorous stand of vegetation is maintained. Regularly check roadside ditches and other drainage structures after a storm event to ensure that they do not become clogged with silt or other debris.

## **2.4 Construction Debris Ground Cover**

### **2.4.1 Definition**

The use of salvaged construction debris as a ground cover.

### **2.4.2 Purpose**

To serve as a temporary ground cover over denuded urban earth to prevent the transportation of sediment from the site.

### **2.4.3 Conditions When Practice Applies**

Sites in need of temporary cover, where acceptable construction debris is available.

### **2.4.4 Design Criteria**

The construction debris must meet the criteria for “clean fill” as dictated by any District or federal regulations applicable on the site. Examples include the following:

- Unpainted, broken concrete without protruding metal bars
- Unpainted bricks
- Rocks
- Stones
- Reclaimed asphalt pavement
- Untreated wood
- Wood that is not painted with lead-based paint

The plans must clearly indicate the fate of the construction debris, either as reuse on site or acceptable reuse/disposal off-site.

In cases where the material is to be used as a gravel subbase for a future paved surface or any other permanent feature of the site, the materials must meet all applicable design criteria in terms of particle size, strength, and other physical properties and must be approved by the design engineer.

When used as a temporary cover, spread the construction debris to a depth of 3 to 4 inches covering the denuded earth on the site, then compact and level.

### **2.4.5 Construction Specifications**

1. During demolition, sort materials, and ensure that materials used for erosion control are approved for this purpose by the design engineer or their representative.
2. Ensure that the bare ground surface is dry and compacted before spreading the debris layer.
3. Spread and compact to a depth of 3 to 4 inches.

### **2.4.6 Maintenance**

During construction, replenish and compact the surface with acceptable material if the surface is disturbed to expose bare soil, or if soil is tracked onto the surface and may be exported off-site. At the close of construction, properly dispose of or reuse the material, as indicated on the construction plans.

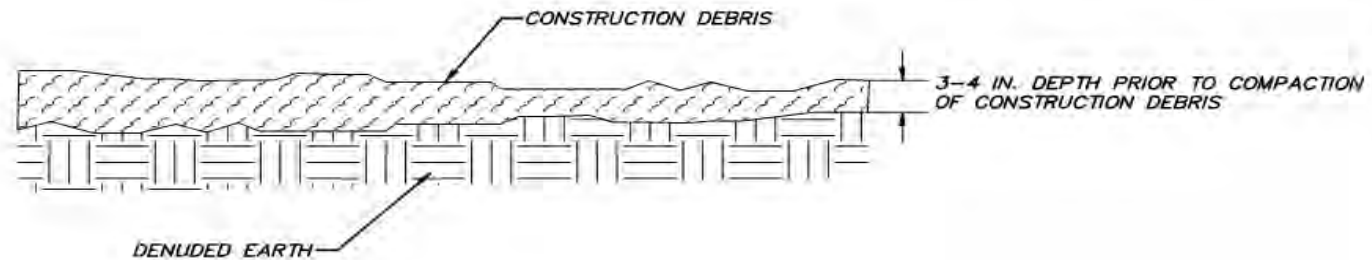

**CONSTRUCTION SPECIFICATIONS**

1. DURING DEMOLITION, SORT MATERIALS, AND ENSURE THAT MATERIALS USED FOR EROSION CONTROL ARE APPROVED FOR THIS PURPOSE BY THE DESIGN ENGINEER OR THEIR REPRESENTATIVE.
2. ENSURE THAT THE BARE GROUND SURFACE IS DRY AND COMPACTED BEFORE SPREADING THE DEBRIS LAYER.
3. SPREAD AND COMPACT TO A DEPTH OF 3 TO 4 INCHES.
4. DURING CONSTRUCTION, REPLENISH AND COMPACT THE SURFACE WITH ACCEPTABLE MATERIAL IF THE SURFACE IS DISTURBED, EXPOSING BARE SOIL, OR IF SOIL IS TRACKED INTO THE SURFACE AND MAY BE EXPORTED OFF SITE. AT THE CLOSE OF CONSTRUCTION, PROPERLY DISPOSE OF OR REUSE THE MATERIAL, AS INDICATED ON THE CONSTRUCTION PLANS.

DATE	APPR	
REVISED		
ISSUED:		
	REFERENCE	

**CONSTRUCTION DEBRIS  
GROUND COVER**

★ ★ ★ DISTRICT OF COLUMBIA  
DEPARTMENT OF ENERGY &  
ENVIRONMENT

DWG. NO 204.1

SOURCE: 2011 MARYLAND STANDARDS & SPECIFICATIONS

Detail 3 – 204.1 Construction Debris Ground Cover

## **2.5 Land Grading**

### **2.5.1 Definition**

Reshaping of the existing land surface in accordance with a plan as determined by the engineering survey and layout.

### **2.5.2 Purpose**

To provide for erosion control and vegetative establishment on areas where the existing land surface is to be reshaped by grading.

### **2.5.3 Condition Where Practice Applies**

Any site where land grading will occur.

### **2.5.4 Design Criteria**

The grading plan should incorporate building designs and street layouts that utilize existing topography, retain desirable natural surroundings, and avoid extreme grade modifications. Information submitted must provide sufficient topographic surveys and soil investigations to determine limitations that must be imposed on the grading operation related to slope stability, effect on adjacent properties and drainage patterns, measures for drainage and water removal and vegetative treatment, etc.

The plan must show existing and proposed contours of the area(s) to be graded. The plan must also include practices for erosion control, slope stabilization, safe disposal of runoff water and drainage, such as waterways, lined ditches, reverse slope benches (include grade and cross section), grade stabilization structures, retaining walls, and surface and subsurface drains. The plan must also include phasing of these practices. The following must be incorporated into the plan:

1. Balance the cut and fill slopes where possible to minimize off-site transport of soils, and minimize the length of time that ungraded slopes are exposed in the construction sequence.
2. Make provisions to safely conduct surface runoff to storm drains, protected outlets, or stable water courses to ensure that surface runoff will not damage slopes or other graded areas.
3. Cut and fill slopes that are to be stabilized with grasses must not be steeper than 2:1. (Where the slope is to be mowed the slope should be no steeper than 3:1; 4:1 slopes are preferred because of safety factors related to mowing steep slopes.) Slopes exceeding 2:1 require special design and stabilization considerations that must be adequately shown on the plans.
4. Provide benched slopes whenever the vertical interval (height) of any 2:1 slope exceeds 20 feet, any 3:1 slope exceeds 30 feet, and any 4:1 slope exceeds 40 feet. Locate benches to divide the slope face as equally as possible and convey the water to a stable outlet. Take into consideration soils, seeps, rock outcrops, and other topographic features when designing benches.

Benches must be a minimum of 6 feet wide to make maintenance easier.

Design benches with a reverse slope of 6:1 or flatter to the toe of the upper slope and with a minimum of 1 foot in depth. Bench gradient to the outlet must be between 2% and 3%, unless accompanied by appropriate design and computations.

The flow length within a bench must not exceed 800 feet unless accompanied by appropriate design and computations. For flow channel stabilization, see Section 4.4 Temporary Swales.

5. Divert surface water from the face of all cut and/or fill slopes using earth dikes, ditches, and swales or convey downslope using a designed structure, except where all the following apply:
  - (a) The face of the slope is stabilized, and the face of all graded slopes is protected from surface runoff until they are stabilized.
  - (b) The face of the slope is not subject to any concentrated flows of surface water such as from natural drainageways, graded swales, downspouts, etc.
  - (c) The face of the slope is protected by special erosion control materials, including, but not limited to, approved vegetative stabilization practices, rip-rap, or other approved stabilization methods.
6. Use serrated slopes (step cuts) to hold moisture, lime, fertilizer, and seed. The steepest allowable slope is 1.5:1 for rippable rocks and 2:1 for other surfaces. Divert overland flow from the top of all serrated cut slopes and carry to a suitable outlet.
7. Provide subsurface drainage where necessary to intercept seepage that would otherwise adversely affect slope stability or create excessively wet site conditions.
8. Do not create slopes so close to property lines as to endanger adjoining properties without adequately protecting such properties against sedimentation, erosion, slippage, settlement, subsidence, or other related damages.
9. Fill material must be uncontaminated and in compliance with all applicable regulations, must meet the engineering properties dictated by the design engineer, and must meet all applicable design standards and regulations.
10. Stabilize all disturbed areas structurally or vegetatively in compliance with other standards in this document.

#### Fill Criteria

1. The fill material must be free of contamination levels of any pollutant that is, or may be considered to represent, a possible health hazard to the public or may be detrimental to surface or ground water quality, or which may cause damage to property or the drainage system.
2. All fill material must be free of hazardous materials and must comply all applicable District and federal regulations.
3. Fill must be compacted in compliance with engineering properties dictated by the site plan.

### **2.5.5 Construction Specifications**

1. Install perimeter controls, diversion ditches, and other erosion control measures before exposing cut and fill slopes.
2. Complete site clearing and grading in compliance with the construction sequence identified on the ESC Plan.
3. Provide erosion and sediment controls on all temporary fill piles generated during construction.
4. Ensure that all supplemental fill created during the grading process is disposed of properly.
5. In cases where fill slopes or soil piles cannot be stabilized before the close of the work day, utilize temporary erosion control measures such as plastic sheeting to ensure that soil is not exposed.
6. Confirm that all fills are compacted in compliance with the standards prescribed in the site plan.
7. Remove temporary diversions and erosion controls once slopes have been stabilized permanently.

### **2.5.6 Maintenance**

Immediately replace any failed diversion measures, and immediately regrade and stabilize any portions of the slopes that have begun to form rills or gullies. Ensure that stockpiles are stabilized with vegetation or with another temporary cover throughout the construction process. Maintain all diversion measures per the details outlined in Chapter 4 Conveyance.



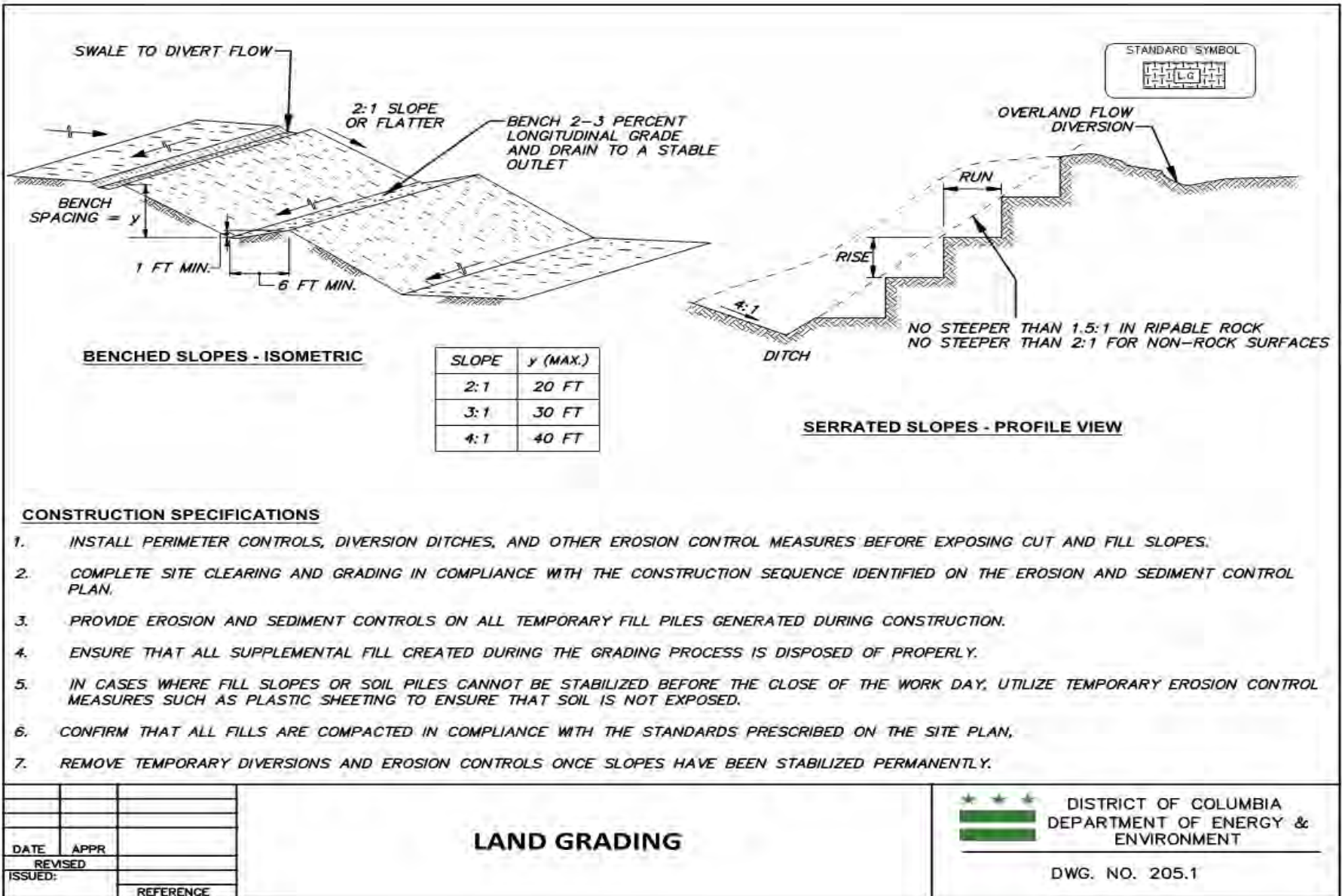

Detail 4 – 205.1 Land Grading

## **2.6 Topsoiling**

### **2.6.1 Definition**

Placement of topsoil over prepared subsoil prior to establishing permanent vegetation.

### **2.6.2 Purpose**

To provide a suitable soil medium for vegetative growth.

### **2.6.3 Conditions Where Practice Applies**

This practice is recommended for areas with 2:1 or flatter slopes where one or more of the following apply:

1. The texture, pH, or nutrient balance of the exposed subsoil/parent material is not adequate to produce vegetative growth.
2. The soil material is so shallow that the rooting zone is not deep enough to support plants or furnish continuing supplies of moisture and plant nutrients.
3. The original soil to be vegetated contains material toxic to plant growth.
4. The soil is so acidic that treatment with limestone is not feasible.

Areas having slopes steeper than 2:1 require special consideration and design for adequate stabilization. These areas must have the appropriate stabilization shown on the plans.

### **2.6.4 Design Criteria**

Topsoil salvaged from the existing site may be used if it meets the standards in these specifications. Place topsoil and apply soil amendments as specified in Section 2.10 Vegetative Stabilization. Soil to be used as topsoil must meet the following specifications:

1. Topsoil must be a loam, sandy loam, clay loam, silt loam, sandy clay loam, or loamy sand. Other soils may be used if recommended by an agronomist or soil scientist and approved by DOEE. Regardless, topsoil must not be a mixture of contrasting textured subsoils and must contain less than 5% by volume of cinders, stones, slag, coarse fragments, gravel, sticks, roots, trash, or other materials larger than 1 inch in diameter.
2. Topsoil must be free of noxious plants or plant parts such as Bermuda grass, quackgrass, Johnsongrass, nutsedge, poison ivy, thistle, other poisonous plants, or others as specified in Section 2.10 Vegetative Stabilization. Topsoil must also be free from invasive plants or plant parts.
3. Where the subsoil is either highly acidic or composed of heavy clays, spread ground limestone at the rate of 4–8 tons per acre (200–400 pounds per 1,000 square feet) prior to the placement of topsoil. Distribute lime uniformly over designated areas and work into the soil in conjunction with tillage operations as described in the next step.

For sites with disturbed areas over 5 acres, obtain test results dictating fertilizer and lime amendments required to bring the soil into compliance with the requirements set forth in Section 2.10 Vegetative Stabilization. Alternatives to natural topsoil and alternative soil amendments, such as composted sewage sludge or other composted materials, may be used in place of fertilizer and lime, as allowed by other applicable regulations and as approved by a certified agronomist or soil scientist.

### **2.6.5 Construction Specifications**

1. When topsoiling, maintain needed erosion and sediment control practices such as diversions, grade stabilization structures, earth dikes, silt fence, and sediment traps and basins.
2. Grades on the areas to be topsoiled, which have been previously established, must be maintained, though now with an additional 4 to 8 inches height in elevation.
3. After the areas to be topsoiled have been brought to grade, and immediately prior to dumping and spreading the topsoil, loosen the subgrade by discing or by scarifying to a depth of a least 4 inches to permit bonding of the topsoil to the subsoil. Pack the subsoil by passing a bulldozer up and down over the entire surface area of the slope to create horizontal erosion check slots to prevent topsoil from sliding down the slope.
4. Uniformly distribute topsoil in a 4-inch to 8-inch layer and lightly compact to a minimum thickness of 4 inches. Perform spreading in such a manner that sodding or seeding can proceed with a minimum of additional soil preparation and tillage. Correct any irregularities in the surface resulting from topsoiling or other operations to prevent the formation of depressions or water pockets.
5. Do not place topsoil while the topsoil or subsoil is in a frozen or muddy condition, when the subsoil is excessively wet, or in a condition that may otherwise be detrimental to proper grading and seedbed preparation.

### **2.6.6 Maintenance**

After precipitation events, confirm that topsoil and subsoil are properly bonded and no sloughing has occurred.

## **2.7 Mulching**

### **2.7.1 Definition**

The application of a protective layer of mulch or other suitable material to the soil surface.

### **2.7.2 Purpose**

To protect the soil surface from the forces of raindrop impact and overland flow. Mulch helps to conserve moisture, reduce runoff and erosion, control weeds, prevent soil crusting, and promote the establishment of desired vegetation. Mulch is frequently used to accent landscape plantings.

### **2.7.3 Conditions Where Practice Applies**

Mulching can be used at any time where protection of the soil surface is desired. The primary purpose of mulching is to protect newly seeded disturbed areas. However, it can also be used for stand-alone protection of the soil surface under adverse weather conditions when seed germination could be jeopardized. Mulch may also be used together with plantings of trees, shrubs, or certain ground cover that do not provide adequate soil stabilization by themselves.

Use mulching in conjunction with temporary seeding operation as specified in Section 2.10 Vegetative Stabilization.

### **2.7.4 Design Criteria**

A surface mulch is the most effective, practical means of controlling runoff and erosion on disturbed land prior to vegetation establishment. Mulch reduces soil moisture loss by evaporation, prevents crusting and sealing of the soil surface, moderates soil temperatures, provides a suitable microclimate for seed germination, and may increase the infiltration rate of the soil.

Organic mulches such as straw, wood chips, and shredded bark have been found to be the most effective. Do not use materials that may be sources of competing weed and grass seeds. Be aware that decomposition of some wood products can tie up significant amounts of soil nitrogen, making it necessary to modify fertilization rates or add fertilizer with the mulch.

Various types of netting materials are available to anchor organic mulches. Chemical soil stabilizers or soil binders are less effective than other types of mulches when used alone. These products are primarily useful for tacking wood fiber mulches.

Choose materials for mulching based on soil conditions, season, type of vegetation, and size of the area. A properly applied and tacked mulch is always beneficial. It is especially important when conditions for germination are not optimum, such as midsummer and early winter, and on difficult areas such as cut slopes and slopes with southern exposures.

#### Mulch Materials

1. Straw must be unrotted small grain straw. Mulch materials must be relatively free of weeds and must be free of noxious weeds such as thistles, Johnsongrass, and quackgrass. Spread

mulch uniformly by hand or mechanically. Straw can be windblown and must be anchored down by an acceptable method.

2. Wood chips are particularly well suited for utility and road rights-of-way, as well as areas that will not be closely mowed or around ornamental plantings. Wood chips do not require tacking. Because they decompose slowly, they must be treated with 12 pounds of nitrogen per ton to prevent nutrient deficiency in plants. Mulch can be inexpensive if chips are obtained from trees cleared on the site.
3. Wood fiber consists of specially prepared wood cellulose processed into a uniform fibrous physical state. It is used in hydroseeding operations and applied as part of a slurry. It creates the best seed-soil contact when applied over top of (as a separate operation) newly seeded areas. These fibers do not require tacking, although tacking agents or binders are sometimes used in conjunction with the application of fiber mulch. The following conditions apply to wood fiber:
  - (a) Wood fiber is to be dyed green or contain a green dye in the package that will provide an appropriate color to facilitate visual inspection of the uniformly spread slurry.
  - (b) Wood fiber, including dye, must contain no germination or growth inhibiting factors.
  - (c) Wood fiber materials are to be manufactured and processed in such a manner that the wood cellulose fiber mulch will remain in uniform suspension in water under agitation and will blend with seed, fertilizer, and other additives to form a homogeneous slurry. The mulch material must form a blotter-like ground cover on application, having moisture absorption and percolation properties, and must cover and hold grass seed in contact with the soil without inhibiting the growth of the grass seedlings.
  - (d) Wood fiber material must not contain elements or compounds at concentration levels that will be phytotoxic.
  - (e) Wood fiber must conform to the following physical requirements: fiber length of approximately 10 millimeters, diameter of approximately 1 millimeter, pH range of 4.0 to 8.5, ash content of 1.6% maximum, and water holding capacity of 90% minimum.

### **2.7.5 Construction Specifications**

1. Prior to mulching, install any needed erosion and sediment control practices such as diversions, grade stabilization structures, berms, channels, and sediment traps and basins.
2. Apply seed and soil amendments at required rates to bring the soil into compliance with the requirements set forth in Section 2.10 Vegetative Stabilization.
3. Apply mulch at required rates. Depending on site conditions, hydraulically applied mulches may be applied in a one-step process where all components may be mixed together in single tank loads. Consult with the manufacturer for further details.
  - (a) Straw – Apply straw mulch over all seeded areas at the rate of 2 tons per acre, or 2 bales per 1,000 square feet, to a uniform loose depth of 1 to 2 inches. Apply so that the soil surface is not exposed.
  - (b) Wood chips – Apply wood chips at the rate of approximately 10-20 tons per acre or 500 to 900 pounds per 1,000 square feet; the depth should be 2 to 7 inches.

- (c) Wood cellulose fiber – Apply wood cellulose fiber at a dry weight rate of 2,000 pounds per acre. Mix the wood cellulose fiber with water to attain a mixture with a maximum of 50 pounds of wood cellulose fiber per 100 gallons of water. Wood cellulose fiber is not typically used on slopes steeper than 5%. For steeper slopes, apply at rates or in conjunction with tackifiers per manufacturer’s specifications based on slope and other site characteristics. In hydroseeding operations, a green dye added to the slurry assures a uniform application.
4. Anchor mulch immediately following application to minimize loss by wind or water. Depending upon the size of the area and erosion hazard, use one of the following methods:
- (a) Mulch anchoring tool – A mulch anchoring tool is a tractor drawn implement designed to punch and anchor mulch into the soil surface a minimum of 2 inches. This practice is most effective on large areas, but is limited to flatter slopes where equipment can operate safely. If used on sloping land, this practice should follow the contour.
  - (b) Liquid mulch binders – Application of liquid mulch binders and tackifiers should be heaviest at the edges of areas and at crests of ridges and banks to resist wind. Apply binder uniformly to the rest of the area. Binders may be applied after mulch is spread, or it may be sprayed into the mulch as it is being blown onto the soil. Applying straw and binder together is the most effective method.
  - (c) Synthetic binders – Synthetic binders must follow the application rates specified by the manufacturer. Application of liquid binders needs to be heavier at the edges where wind catches mulch, such as in valleys and on crests of banks. Use of asphalt binders is strictly prohibited.
  - (d) Netting – Lightweight plastic, cotton, jute, wire, or paper nets may be stapled over the mulch according to the manufacturer’s recommendations.
  - (e) Mats – Mats promote seedling growth in the same way as organic mulches. They are very useful in establishing grass in channels and waterways. A wide variety of synthetic and organic materials are available. “Excelsior” is a wood fiber mat that should not be confused with wood fiber slurry (see Section 2.9 Rolled Erosion Control Products).
5. When installing nets and mats, it is critical to obtain a firm, continuous contact between the material and the soil. Without such contact, the material is useless, and erosion will occur underneath. Any mat or blanket-type product used as a protective mulch should provide cover of at least 30% of the surface where it is applied.
- (a) Apply lime, fertilizer, and seed before laying the net or mat.
  - (b) Start laying the net from the top of the slope and unroll it down the grade. Allow netting to lay loosely on the soil or mulch cover but without wrinkles—do not stretch.
  - (c) To secure the net, bury the upslope end in a slot or trench no less than 6 inches deep, cover with soil, and tamp firmly. Staple the net every 12 inches across the top end and every 3 feet around the edges and bottom. Where 2 strips of net are laid side by side, overlap the adjacent edges 3 inches and staple together. Each strip of netting should also be stapled down the center, every 3 feet. Do not stretch the net when applying staples.
  - (d) To join two strips, cut a trench to anchor the end of the new net. Overlap the end of the previous roll 18 inches, and staple every 12 inches just below the anchor slot.

### **2.7.6 Maintenance**

Periodically inspect all mulches and soil coverings to check for erosion, particularly after precipitation events. Where erosion is observed in mulched areas, apply additional mulch. Inspect nets and mats after rainstorms for dislocation or failure. If washouts or breakage occur, reinstall netting or matting as necessary after repairing damage to the slope or ditch. Inspections should take place until grasses are firmly established. Where mulch is used in conjunction with ornamental plantings, inspect periodically throughout the year to determine if mulch is maintaining coverage of the soil surface; repair as needed.

## **2.8 Compost Blankets**

### **2.8.1 Definition**

Compost is the organic product resulting from the controlled biological decomposition of organic material. The decomposition occurs under aerobic conditions that generate heat to sanitize and stabilize the compost to the point that it is appropriate for its particular application. A compost blanket is a slope stabilization, erosion control, and vegetation establishment practice used on construction sites to stabilize bare, disturbed, or erodible soils.

### **2.8.2 Purpose**

To temporarily control erosion while in the process of providing permanent vegetative cover.

### **2.8.3 Conditions Where Practice Applies**

Consider compost blankets when soil is poor. Compost blankets can be placed on rocky slopes and shallow or infertile soils to improve the growth medium for grasses. Take care not to apply compost where it can raise the nutrient level of streams; do not apply compost blankets in frequently flooded areas. See also Section 2.10 Vegetative Stabilization.

### **2.8.4 Design Criteria**

Compost blankets are similar to mulch and can cover 100% of the soil surface. Therefore, they provide the beneficial effects characteristic to mulches, including reduced raindrop impact and splash erosion, reduced runoff energy and sheet erosion, buffered soil temperature for plants, decreased moisture evaporation, increased moisture holding capacity at the soil surface, reduced runoff volume and velocity, and increased infiltration. Where planned and applied correctly to a properly prepared subgrade, compost blankets can aid in amending the soil. This amendment can provide benefits to the soil's structure by increasing aggregation, aeration, infiltration and percolation, moisture holding capacity, activity of beneficial microbes, availability of nutrients, plant health, and long-term site sustainability and decreasing erosion and runoff volume and velocity.

Compost should possess no objectionable odors. It must not contain substances toxic to plants, and it must not resemble the raw material from which it was derived. Compost is not a fertilizer. It is recommended that compost utilized on construction sites in the District meet the minimum soil compost amendment requirements as set forth by the DOEE Stormwater Management Guidebook, Appendix J.

Most compost contains a wood based fraction (e.g., bark, ground brush, wood chips, etc.), which is typically removed before the compost is used as a soil amendment. However, this coarser, woody fraction of the compost plays an important role in erosion and sediment control. For certain compost applications, it may be advantageous to add fresh, ground bark or composted, properly sized wood-based material to a compost product to improve its efficacy in a particular application.



In conjunction with other methodologies, a compost blanket may be considered appropriate for erosion and sediment control during the construction process. Compost blankets should only be used to control sheet flow from rainfall. Blankets may not be utilized in areas of concentrated runoff. Blankets may not be utilized in areas subject to vehicular traffic and use by heavy equipment. If the slope is to be landscaped or seeded, avoid very coarse compost as it will make planting and crop establishment more difficult.

Compost blankets may be used for temporary erosion and sediment control applications. This application is appropriate for slopes up to a 2:1 grade and may be used only in areas that have sheet flow drainage patterns (not areas that receive concentrated flows). Slopes steeper than 2:1 may require special installation techniques (consult compost supplier for recommendations).

### **2.8.5 Construction Specifications**

Use the following steps for the installation of compost blankets for erosion and sediment control. Include the steps that will be used in the construction sequence on the approved ESC Plan.

1. Apply the compost blanket to 100% of the area as required on the approved ESC Plan.
2. The blanket must cover 100% of the bare or disturbed soil area. Apply it at a depth of 1½ to 2 inches. Thoroughly mix the seed with the compost prior to application or surface apply to the compost blanket at time of application at the appropriate rates as prescribed by the approved plan.
3. Install compost blankets at least 10 feet over and beyond the shoulder of the slope and/or into the edge of existing vegetation to ensure runoff does not undercut the blanket. When installing into the edge of existing vegetation, take care not to disturb the existing root mat.
4. Design and specify compost blanket application rates based on specific site and climatic conditions (e.g., soil characteristics, existing vegetation), as well as project-related requirements and calculated stormwater runoff.
5. Install and track compost blankets on slopes greater than or equal to 4:1. Track and secure blankets on 3:1 slopes and greater with an adequate rolled erosion control product (see Section 2.9 Rolled Erosion Control Products for installation procedure). Where high winds and wind erosion are expected, install RECPs over the compost blanket, regardless of slope. All other installation procedures and specifications will be as shown on the approved plan and described in the approved construction sequence. Uniformly apply compost as described in the approved construction sequence with the appropriate equipment. If required, use thorough watering to improve settling of the blanket.

### **2.8.6 Maintenance**

Inspect compost blankets weekly and within 24 hours of a rainfall event of ½-inch or greater. If failure or damage to the blanket occurs or if vegetation does not establish within the expected germination time of the selected seed type, reapply compost and seed to the affected area to return it to the original condition. Take additional measures as necessary to establish permanent ground cover. Inspect compost blankets until permanent vegetation is established. Repair an

RECP placed over the compost blanket if it has been moved or damaged by wind or stormwater runoff and/or if part of or the whole blanket is not in contact with the soil surface.

## **2.9 Rolled Erosion Control Products**

### **2.9.1 Definition**

Rolled materials (mats) used to stabilize channels or steep slopes until ground cover is established, or mats that permanently reinforce plantings in highly erosive areas.

### **2.9.2 Purpose**

To aid in controlling erosion by providing a microclimate that protects young vegetation and promotes its establishment. In addition, some RECPs are used to raise the maximum permissible velocity of turf grass stands in channelized areas by reinforcing the turf to resist the forces of erosion during storm events.

### **2.9.3 Conditions Where Practice Applies**

RECPs are recommended for the following conditions:

- On short, steep slopes (3:1 or higher) where erosion hazard is high and planting is likely to be too slow in providing adequate protective cover.
- In vegetated channels where the velocity of design flow exceeds the allowable velocity for vegetation alone.
- On streambanks or tidal shorelines where moving water is likely to wash out new plantings.
- In areas where the forces of wind prevent standard mulching practices from remaining in place until vegetation becomes established.

### **2.9.4 Design Criteria**

Stabilization mats can be applied to problem areas to aid in the initial establishment of vegetation and protect the soil from erosion due to high velocity stormwater runoff. These materials have been improved to the point that they are now being used in many applications where structural linings would have been required in the past. Care must be taken to choose the type of material which is most appropriate for the specific needs of a project. With the large selection of materials available today and constant improvements in the technology, it is impossible to cover them all with this standard and specification, or to keep it current. Although some general guidelines are provided, the designer should always consult the manufacturer's recommendations for final selection and design.

RECPs include a wide range of commercially available products, and some of these may include specific design and installation instructions. Regardless of the specific design, RECPs must be composed of non-leaching materials that are non-toxic to humans and wildlife.

There are two categories of RECPs: Temporary Erosion Control Matting (TECM) and Turf Reinforcement Mats (TRMs).

Temporary Erosion Control Matting

Temporary Erosion Control Matting is a degradable soil stabilization blanket, typically consisting of photodegradable plastic netting that covers and may be intertwined with natural organic or manmade mulch. It provides temporary erosion control until vegetation can be established. Since the materials which compose the soil stabilization blankets will deteriorate over time, they should be used in permanent conveyance channels with the realization that the system's resistance to erosion is based on the type of vegetation planted and the existing soil characteristics.

In addition to the matting materials presented in this section, bonded fiber matrices presented in Section 2.7 Mulching may also be appropriate. Requirements for temporary matting are summarized in Table 2.1.

**Table 2.1 Temporary Erosion Control Matting Selection Criteria**

Typical Composition <sup>1</sup>	Lifespan (Degradation Time in Months)	Maximum Slope for Slope Stabilization	Maximum Shear Stress for Temporary Channel Lining (lb/ft <sup>2</sup> )
<ul style="list-style-type: none"> <li>• 100% agricultural straw<sup>2</sup> or wood excelsior fiber<sup>3</sup></li> <li>• Single top netting</li> </ul>	12	3:1	1.55
<ul style="list-style-type: none"> <li>• 100% agricultural straw<sup>2</sup> or wood excelsior fiber<sup>3</sup></li> <li>• Double netting (top and bottom)</li> </ul>	12	2:1	1.65
<ul style="list-style-type: none"> <li>• 70% agricultural straw or wood excelsior fiber</li> <li>• 30% coir fibers</li> <li>• Double woven netting</li> </ul>	12–24	1.5:1	1.80
<ul style="list-style-type: none"> <li>• 100% coir or polypropylene fibers</li> <li>• Double woven plastic or biodegradable nettings with UV stabilization</li> </ul>	18–36	1:1	2.00

<sup>1</sup>Derived from Delaware ESC Handbook

<sup>2</sup>Min. 0.5 lb/sy

<sup>3</sup>Min. 0.8 lb/sy; min. 80% 6-inch or longer fiber length

Turf Reinforcement Mats

Turf reinforcement mats are soil-stabilization matting that consists of non-degradable, 3-dimensional plastic or other durable material structure that can be filled with soil prior to planting. This configuration provides a matrix for root growth where the matting becomes entangled and penetrated by roots, forming a continuous anchorage for surface growth and promoting enhanced energy dissipation. Since TRMs are non-degradable, they can be used in

permanent conveyance channels and can withstand higher velocities of flow than the vegetation and soil would normally allow.

TRMs provide the following benefits (in addition to those noted for TECM):

1. Allows the use of vegetated lining under conditions that would normally require concrete or riprap.
2. Traps soil in stormwater runoff and allows it to fill the matrix, thus becoming a growth medium for the development of roots.
3. When embedded in the soil within stormwater channels, TRMs act with the vegetative root system to form an erosion-resistant cover that resists hydraulic lift and shear forces.
4. For slope stability problems, TRMs can improve the geotechnical performance of the native soil.

The specific materials of TRMs vary by manufacturer. Follow manufacturer specifications when choosing an appropriate TRM for slope and shear stress conditions.

#### Other Materials

1. Apply soil and vegetation in a manner consistent with the guidance provided in Section 2.6 Topsoiling and Section 2.10 Vegetative Stabilization.
2. Construct staples and stakes using 0.125-inch diameter new steel wire formed into a “U” shape, not less than 6 inches in length with a throat of 1-inch in width, or wood stakes that are 2 feet long, 1-inch by 2-inch, with a 45-degree downward notch that is 6 inches from top of the stake, unless a different staple is explicitly recommended by the manufacturer.

### **2.9.5 Construction Specifications**

#### Slope Stabilization

1. Prepare soil before installing matting, including application of lime, fertilizer, and seed. For soil-filled RECPs, the planting bed may be installed after the product is installed.
2. Start laying the protective covering from the top of slope and unroll downgrade.
3. Bury the up-slope ends of the protective covering in an anchor slot no less than 6 inches deep. Tamp earth firmly over the material. Staple the material at a minimum of every 12 inches across the top end.
4. Install edges of parallel mats with a minimum of 2-inch overlap.
5. When mats need to be spliced down the slope, install them end over end, with a minimum 4-inch overlap, and staple every 12 inches. The manufacturers’ specifications will indicate the density of staples.

#### Channel Stabilization

1. Prepare soil before installing matting, including application of lime, fertilizer, and seed. For soil-filled RECPs, the planting bed may be installed after the product is installed.

2. Start laying the protective covering at the channel inlet (i.e., highest elevation) along the bottom of the channel. Unroll in the direction of flow.
3. At the channel inlet, bury the first mats placed in an anchor slot no less than 6 inches deep. Tamp earth firmly over the material. Staple the material at a minimum of every 12 inches across the top end.
4. Lay mats end over end with a 6-inch overlap and secure with a double row of staggered staples 4 inches apart.
5. In high flow applications, install a staple check dam (a double row of staggered staples 4 inches apart across the entire channel width), at 30-foot to 40-foot intervals.
6. Anchor the terminal end of each mat in a 6-inch by 6-inch trench. Backfill and compact after stapling.
7. Mats installed along the side slopes should overlap the center mat by 4 inches. Install with a staple density or spacing per manufacturers' recommendations.

### **2.9.6 Maintenance**

Inspect all RECPs periodically following installation, particularly after rainstorms to check for erosion and undermining. Any dislocation or failure must be repaired immediately. If washouts or breakage occurs, reinstall the material after repairing damage to the slope or ditch. Continue to monitor these areas until they become permanently stabilized; at that time an annual inspection should be adequate.

STANDARD SYMBOL  
 RECPs - \* lb/ft<sup>2</sup>  
 \*(INCLUDE SHEAR STRESS)

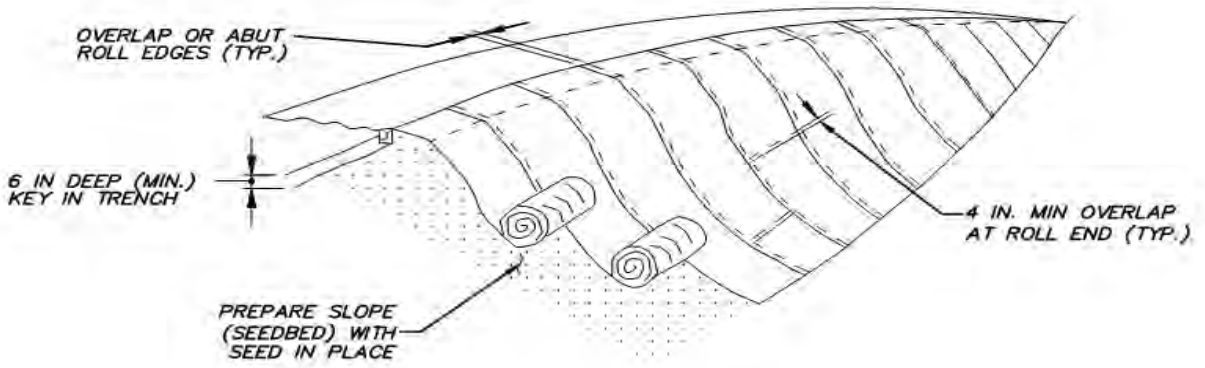

**ISOMETRIC VIEW**

**CONSTRUCTION SPECIFICATIONS**

1. PREPARE SOIL BEFORE INSTALLING MATTING, INCLUDING APPLICATION OF LIME, FERTILIZER, AND SEED. FOR SOIL-FILLED RECPs, THE PLANTING BED MAY BE INSTALLED AFTER THE PRODUCT IS INSTALLED.
2. START LAYING THE PROTECTIVE COVERING FROM THE TOP OF SLOPE AND UNROLL DOWN-GRADE.
3. BURY THE UP-SLOPE ENDS OF THE PROTECTIVE COVERING IN AN ANCHOR SLOT NO LESS THAN 6 INCHES DEEP. TAMP EARTH FIRMLY OVER THE MATERIAL. STAPLE THE MATERIAL AT A MINIMUM OF EVERY 12 INCHES ACROSS THE TOP END.
4. INSTALL EDGES OF PARALLEL MATS WITH A MINIMUM OF 2-INCH OVERLAP.
5. WHEN MATS NEED TO BE SPLICED DOWN THE SLOPE, INSTALL THEM END OVER END, WITH A MINIMUM 4-INCH OVERLAP, AND STAPLE EVERY 12 INCHES. THE MANUFACTURER'S SPECIFICATIONS WILL INDICATE THE DENSITY OF STAPLES.

DATE	APPR	
	REVISED	
ISSUED:		
	REFERENCE	

**ROLLED EROSION CONTROL PRODUCTS  
 SLOPE STABILIZATION**

\*\*\* DISTRICT OF COLUMBIA  
 DEPARTMENT OF ENERGY &  
 ENVIRONMENT

DWG. NO 209.1

SOURCE: 2011 MARYLAND STANDARDS & SPECIFICATIONS

Detail 5 – 209.1 Rolled Erosion Control Products Slope Stabilization

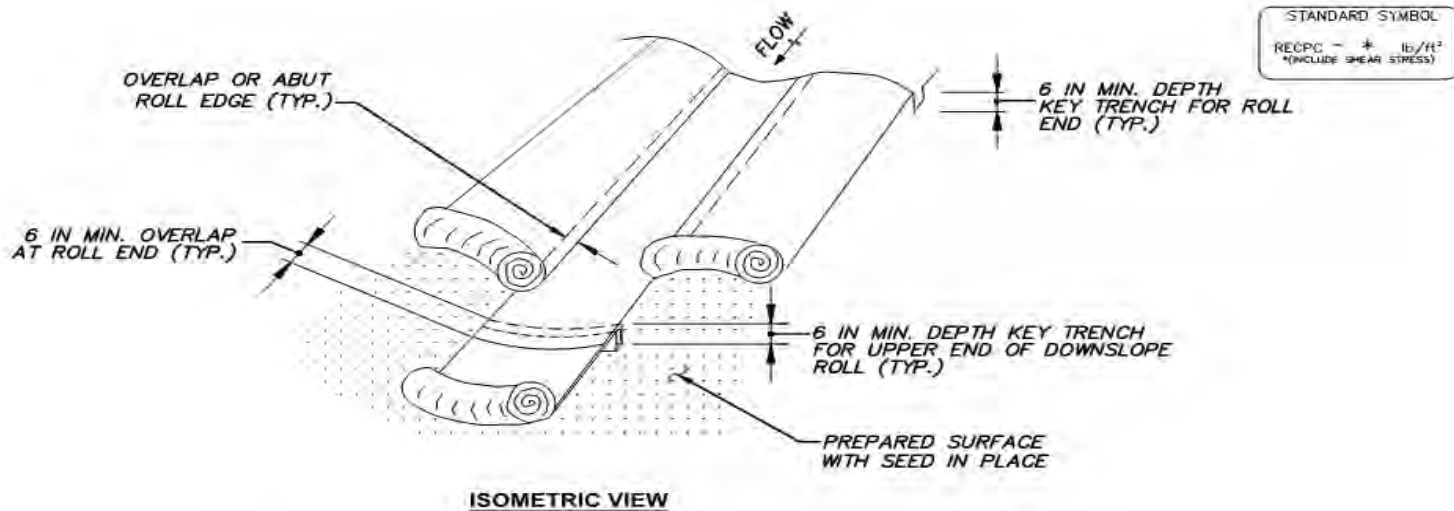

**CONSTRUCTION SPECIFICATIONS**

1. PREPARE SOIL BEFORE INSTALLING MATTING, INCLUDING APPLICATION OF LIME, FERTILIZER, AND SEED. FOR SOIL-FILLED RECPs, THE PLANTING BED MAY BE INSTALLED AFTER THE PRODUCT IS INSTALLED.
2. START LAYING THE PROTECTIVE COVERING AT THE CHANNEL INLET (I.E., HIGHEST ELEVATION) ALONG THE BOTTOM OF THE CHANNEL. UNROLL IN THE DIRECTION OF FLOW.
3. AT THE CHANNEL INLET, BURY THE FIRST MATS IN AN ANCHOR SLOT NO LESS THAN 6 INCHES DEEP. TAMP EARTH FIRMLY OVER THE MATERIAL. STAPLE THE MATERIAL AT A MINIMUM OF EVERY 12 INCHES ACROSS THE TOP END.
4. LAY MATS END OVER END WITH A 6-INCH OVERLAP AND SECURED WITH A DOUBLE ROW OF STAGGERED STAPLES 4 INCHES APART.
5. IN HIGH FLOW APPLICATIONS, INSTALL A STAPLE CHECK DAM (A DOUBLE ROW OF STAGGERED STAPLES 4 INCHES APART ACROSS THE ENTIRE CHANNEL WIDTH), AT 30-FOOT TO 40-FOOT INTERVALS.
6. ANCHOR THE TERMINAL END OF EACH MAT IN A 6-INCH BY 6-INCH TRENCH. BACKFILL AND COMPACT AFTER STAPLING.
7. MATS INSTALLED ALONG THE SIDE SLOPES SHOULD OVERLAP THE CENTER MAT BY 4 INCHES. INSTALL WITH A STAPLE DENSITY OR SPACING PER MANUFACTURERS' RECOMMENDATIONS.

DATE	APPR	
REVISED		
ISSUED:		
		REFERENCE

**ROLLED EROSION CONTROL PRODUCTS  
CHANNEL STABILIZATION**

 DISTRICT OF COLUMBIA  
 DEPARTMENT OF ENERGY &  
 ENVIRONMENT

DWG. NO 209.2

SOURCE: 2011 MARYLAND STANDARDS & SPECIFICATIONS

Detail 6 – 209.2 Rolled Erosion Control Products Channel Stabilization



## **2.10 Vegetative Stabilization**

### **2.10.1 Definition**

Using vegetation as cover for barren soil to protect it from forces that cause erosion. This specification includes both temporary and permanent stabilization.

### **2.10.2 Purpose**

Use vegetative stabilization specifications to promote the establishment of vegetation on exposed soil. When soil is stabilized with vegetation, the soil is less likely to erode and more likely to allow infiltration of rainfall, thereby reducing sediment loads and runoff to downstream areas and improving wildlife habitat and visual resources.

### **2.10.3 Conditions Where Practice Applies**

Use this practice on denuded areas as specified on the ESC and SWM Plans. It may be used on highly erodible or critically eroding areas. This specification is divided into Temporary Seeding, to quickly establish vegetative cover for short duration (up to one year), and Permanent Seeding, for long-term vegetative cover. Examples of applicable areas for temporary seeding are temporary soil stockpiles, cleared areas being left idle between construction phases, and earth dikes or other temporary erosion control measures. Examples of permanent seeding include lawns, dams, cut and fill slopes, and other areas at final grade.

Vegetative stabilization must be in place to stabilize the surface of all perimeter controls, dikes, swales, ditches, perimeter slopes, and all slopes greater than 3:1 within 7 days. All other disturbed or graded areas on the project site must be stabilized within 14 days.

### **2.10.4 Design Criteria**

Design criteria for both temporary and permanent vegetative stabilization includes seed specifications, seed mixtures, and soil amendments.

#### Seed Specifications

For both temporary and permanent soil stabilization, seed must meet the following specifications:

1. All seed must be subject to retesting by a recognized seed laboratory within the 6 months immediately preceding the date of sowing such material on the site.

Note: Seed tags must be made available to the inspector to verify type and rate of seed used.

2. Seed quality must be consistent with the criteria outlined in Table 2.2.
3. The inoculant for treating legume seed in the seed mixtures must be a pure culture of nitrogen-fixing bacteria prepared specifically for the species. Do not use inoculants beyond the date indicated on the container. Add fresh inoculant as directed on the package. Use 4 times the recommended rate when hydroseeding.

Note: It is very important to keep the inoculant as cool as possible until it is used. Temperatures above 75–80°F can weaken bacteria and make the inoculant less effective.

Table 2.2 Quality of Seed

Species	Minimum Seed Purity (%)	Minimum Seed Germination (%)
Cool-Season Grasses		
Barley	98	85
Bentgrass, Creeping	95	85
Bluegrass, Canada	90	80
Bluegrass, Kentucky	97	80
Bluegrass, Rough	96	80
Fescue, Chewings	97	85
Fescue, Creeping Red	97	85
Fescue, Hard	97	85
Fescue, Sheep	97	85
Fescue, Tall	97	85
Oats	98	85
Orchardgrass	90	80
Redtop	92	80
Rye, Cereal	98	85
Ryegrass, Annual or Perennial	97	85
Saltgrass, Alkali	85	80
Wheat	98	85
Wild Rye, Canada	85	70
Warm-Season Grasses		
Bluestem, Big	60	60
Bluestem, Little	55	60
Deertongue	95	75
Indiangrass	60	60
Millet, Foxtail or Pearl	98	80
Panicgrass, Coastal	95	70
Switchgrass	95	75
Legumes/Forbs		
Clover, Alsike	99	85
Clover, Red	99	85
Clover, White	99	90
Flatpea	98	75
Lespedeza, Common	98	80
Pea, Partridge	98	70
Trefoil, Birdsfoot	98	85

### Temporary Stabilization

Use temporary seeding to provide cover on disturbed areas for up to 12 months. Longer duration of vegetative cover requires permanent seeding.

Include in the plan the following Temporary Seeding Summary (Table 2.3) that identifies temporary seeding materials rates, species, and fertilizer/lime rates. Use Table 2.4 to complete the summary table. If Table 2.3 is not put on the plans and completed, then Table 2.4 must be put on the plans.

Soil tests are not required for temporary seeding, but the plan should identify recommended fertilizer and/or lime application rates. If soil testing is completed, report the testing agency's results on the plans. If a soil test has been performed, delete the rates shown in Table 2.3 and write in the rates recommended by the testing agency.

**Table 2.3 Temporary Seeding Summary**

Temporary Seeding Summary					
Seed Mixture				Fertilizer Rate (10-10-10)	Lime Rate
Species	Seeding Rate (indicate units)	Seeding Dates	Seeding Depths		
				436 lb/ac	2 tons/ac
				(10 lb/ 1,000 ft <sup>2</sup> )	(90 lb/ 1,000 ft <sup>2</sup> )

Seed mixtures appropriate to the District of Columbia for temporary seeding are included in Table 2.4, along with appropriate seeding rates, depths, and planting dates.

**Table 2.4 Temporary Seeding for Site Stabilization**

Plant Species	Seeding Rate <sup>1</sup>		Seeding Depth (inches) <sup>2</sup>	Recommended Seeding Dates Plant Hardiness Zone 7a and 7b <sup>3</sup>
	lb/ac	lb/1,000 ft <sup>2</sup>		
Cool-Season Grasses				
Annual Ryegrass	40	1.0	0.5	Feb. 15 to Apr. 30; Aug. 15 to Nov. 30
Barley	96	2.2	1.0	Feb. 15 to Apr. 30; Aug. 15 to Nov. 30
Oats	72	1.7	1.0	Feb. 15 to Apr. 30; Aug. 15 to Nov. 30
Wheat	120	2.8	1.0	Feb. 15 to Apr. 30; Aug. 15 to Nov. 30
Cereal Rye	112	2.8	1.0	Feb. 15 to Apr. 30; Aug. 15 to Dec. 15
Warm-Season Grasses				
Foxtail Millet	30	0.7	0.5	May 1 to Aug. 14
Pearl Millet	20	0.5	0.5	May 1 to Aug. 14

Notes:

<sup>1</sup>Seeding rates for the warm-season grasses are in pounds of pure live seed (PLS). Actual planting rates must be adjusted to reflect percent seed germination and purity, as tested. Adjustments are usually not needed for the cool-season grasses.

Seeding rates listed above are for temporary seedings, when planted alone. When planted as a nurse crop with permanent seed mixes, use 1/3 of the seeding rate listed above for barley, oats, and wheat. For smaller-seeded grasses (annual ryegrass, pearl millet, foxtail millet), do not exceed more than 5% (by weight) of the overall permanent seeding mix. Generally, do not use cereal rye as a nurse crop unless planting will occur in very late fall beyond the seeding dates for other temporary seedings. Cereal rye has allelopathic properties that inhibit the germination and growth of other plants. If it must be used as a nurse crop, seed at 1/3 of the rate listed above.

Oats are the recommended nurse crop for warm-season grasses.

<sup>2</sup>For sandy soils, plant seeds at twice the depth listed above.

<sup>3</sup>The planting dates listed are averages and may require adjustment to reflect local conditions.

### Permanent Stabilization

For permanent seeding, the plan must include the Permanent Seeding Summary with the following information. Use Tables 2.6 and 2.7 to complete the summary table.

**Table 2.5 Permanent Seeding Summary**

Permanent Seeding Summary								
No.	Seed Mixture				Fertilizer Rate (10-20-20)			Lime Rate
	Species	Application Rate (lb/ac)	Seeding Dates	Seeding Depths	N	P <sub>2</sub> O <sub>5</sub>	K <sub>2</sub> O	
					45 lb/ac	90 lb/ac	90lb/ac	2 tons/ac
					(1.0 lb/ 1,000 ft <sup>2</sup> )	(2 lb/ 1,000 ft <sup>2</sup> )	(2 lb/ 1,000 ft <sup>2</sup> )	(90 lb/ 1,000 ft <sup>2</sup> )

### Turfgrass Mixtures

Select a seed mixture from Table 2.6, using Table 2.7 (conditions by mix) as a guideline. Some guidance for common mixes is as follows:

1. Kentucky Bluegrass (full sun mixture) – For use in areas that receive intensive management. The recommended certified Kentucky bluegrass cultivars seeding rate is 1.5 to 2.0 pounds per 1,000 square feet. Choose a minimum of three bluegrass cultivars ranging from a minimum of 10% to a maximum of 35% of the mixture by weight.
2. Kentucky Bluegrass/Perennial Rye (full sun mixture) – For use in full sun areas where rapid establishment is necessary and when turf will receive medium to intensive management. The certified perennial ryegrass cultivars/certified Kentucky bluegrass seeding rate is 2 pounds mixture per 1,000 square feet. A minimum of three Kentucky bluegrass cultivars must be chosen, with each cultivar ranging from 10% to 35% of the mixture by weight.
3. Tall Fescue/Kentucky Bluegrass (full sun mixture) – For use in drought prone areas and/or for areas receiving low to medium management in full sun to medium shade. The recommended mixture includes 95% to 100% certified tall fescue cultivars and 0% to 5% certified Kentucky bluegrass cultivars. The seeding rate is 5 to 8 pounds per 1,000 square feet. One or more cultivars may be blended.
4. Kentucky Bluegrass/Fine Fescue (shade mixture) – For use in areas with shade in bluegrass lawns or for establishment in high quality, intensively managed turf area. The mixture includes 30% to 40% certified Kentucky bluegrass cultivars and 60% to 70% of certified fine fescue. The seeding rate is 1½ to 3 pounds per 1,000 square feet. A minimum of 3 Kentucky bluegrass cultivars must be chosen, with each cultivar ranging from a minimum of 10% to a maximum of 35% of the mixture by weight.

Note: Select turfgrass varieties from those listed in the most current Maryland-Virginia Turfgrass Variety Recommendation Work Group list (<http://www.pubs.ext.vt.edu/>).

**Table 2.6 Recommended Permanent Seeding Mixtures by Site Condition or Purpose**

Site Condition or Purpose of the Planting	Recommended Mix (see Table 2.7)												
	1	2	3	4	5	6	7	8	9	10	11	12	13
Steep Slopes, Roadsides	R	R	R	A	R	A				A	A	R	R
Sand and Gravel Pits, Sanitary Landfills	R	R	R	A	R	A				A	A	R	
Salt-Damaged Areas	A												R
Mine Spoil, Dredged Material, and Spoil Banks	A		R	A	A								
Utility Rights-of-Way	R	R	R	R	R	R	A			R	R	R	
Dikes and Dams	A	A	R	A		R	R	A		R	R	R	
Berms and Low Embankments (not on Ponds)	R	R	R	R	R	R	A	A		R	R	R	A
Pond and Channel Banks, Streambanks	R	R	R	R	A	A	A			A	A		
Grassed Waterways, Diversions, Terraces, Spillways	A				A	R	R	A	R		R		A
Bottom of Drainage Channels, Swales, Detention Basins				A		R	A			A	R		R
Field Borders, Filter Strips, Contour Buffer Strips	R	R	R	A	A	R	A	R	R	R	R	R	A
Wastewater Treatment Strips and Areas								R	A	A			
Heavy Use Areas (Grass Loafing Paddocks for Livestock)								R					
Athletic Fields, Residential and Commercial Lawns							A	R	R		R		
Recreation Areas							R	R	R		R		

R = Recommended mix for this site condition or purpose.

A = Alternative mix, depending on site conditions.

**Table 2.7 Selected List of Permanent Herbaceous Seeding Mixtures**

Mix	Recommended Cultivar	Seeding Rate <sup>1</sup>		Soil Drainage Class <sup>2</sup>	Max. Height (in.)	Maint. Level <sup>3</sup>	Remarks				
		lb/ac	lb/1,000 ft <sup>2</sup>								
<b>Warm-Season/Cool-Season Grass Mixes</b>											
<b>1. SELECT <u>ONE</u> WARM-SEASON GRASS:</b>											
Switch Grass ( <i>Panicum virgatum</i> )	Blackwell, Carthage, Cave-in-the-Rock, or Shelter	10	0.23	E-P	4-7	C-D	All species are native to the area.  Plant this mix with a regular grass drill.  Coastal panicgrass is best adapted to Zones 7a and 7b.  Creeping red fescue is a cool-season grass that will provide erosion protection while the warm-season grass (switchgrass or coastal panicgrass) is becoming established.  Switchgrass, coastal panicgrass, the 'Dawson' variety of creeping red fescue, and partridge pea are moderately salt tolerant. Do not use bush clover or wild indigo on wet sites.				
<b>OR</b> Coastal Panic Grass ( <i>Panicum amarum var. amarulum</i> )	Atlantic	10	0.23								
<b>AND ADD:</b> Creeping Red Fescue ( <i>Festuca rubra var. rubra</i> )	Navigator II	15	0.34								
<b>PLUS <u>ONE</u> OF THE FOLLOWING LEGUMES:</b>											
Partridge Pea ( <i>Chamaecrista fasciculata</i> )	Common	4	0.09								
Bush Clover ( <i>Lespedeza capitata</i> )	Common	2	0.05								
Wild Indigo ( <i>Baptisia tinctoria</i> )	Common	2	0.05								
<b>2. Big Bluestem (<i>Andropogon gerardii</i>)</b>											
Indiangrass ( <i>Sorghastrum nutans</i> )	Niagara or Rountree	6	0.14	E-MW	6-8	C-D	All species are native to the area.  The indiagrass and bluestems have fluffy seeds. Plant with a specialized native seed drill.  Creeping red fescue is a cool-season grass that will provide erosion protection while the warm-season grasses are becoming established.				
Little Bluestem ( <i>Schizachyrium scoparium</i> )	Rumsey	6	0.14								
Creeping Red Fescue ( <i>Festuca rubra var. rubra</i> )	Aldous or Blaze	4	0.09								
	Navigator II	15	0.34								
<b>PLUS <u>ONE</u> OF THE FOLLOWING LEGUMES:</b>											
Partridge Pea ( <i>Chamaecrista fasciculata</i> )	Common	4	0.09								
Bush Clover ( <i>Lespedeza capitata</i> )	Common	2	0.05								
Wild Indigo ( <i>Baptisia tinctoria</i> )	Common	2	0.05								
Showy Tick-Trefoil ( <i>Desmodium canadense</i> )	Common	1	0.05								

Mix	Recommended Cultivar	Seeding Rate <sup>1</sup>		Soil Drainage Class <sup>2</sup>	Max. Height (in.)	Maint. Level <sup>3</sup>	Remarks
		lb/ac	lb/1,000 ft <sup>2</sup>				
<b>Warm-Season/Cool-Season Grass Mixes</b>							
<b>3. SELECT <u>THREE</u> GRASSES:</b> Deertongue ( <i>Dichanthelium clandestinum</i> )  Canada Wild Rye ( <i>Elymus canadensis</i> )  Redtop ( <i>Agrostis gigantean</i> )  <b>PLUS THE FOLLOWING LEGUME:</b>  Common Lespedeza ( <i>Lespedeza striata</i> )	Tioga  Common  Streaker  Kobe	20  3  1  10	0.46  0.07  0.02  0.23	E-MW	4-8	C-D	Excellent for excessively droughty, low pH (acidic) soils.  Canada wild rye and redtop are cool-season grasses that will provide erosion protection while the warm-season grass (deertongue) is becoming established.  Common lespedeza ('Kobe' variety) is a reseeding annual.
<b>4.</b> Deertongue ( <i>Dichanthelium clandestinum</i> )  Creeping Red Fescue ( <i>Festuca rubra</i> var. <i>rubra</i> )  Virginia Wild Rye ( <i>Elymus virginicus</i> )  <u><b>OR</b></u> Canada Wild Rye ( <i>Elymus canadensis</i> )	Tioga  Navigator II  Common  Common	15  20  5  5	0.34  0.46  0.11  0.11	W-P	2-3	C-D	Use Virginia wild rye on moist, shady sites. Use Canada wild rye on droughty sites.
<b>Cool-Season Grass Mixes</b>							
<b>5. SELECT TWO GRASSES:</b> Creeping Red Fescue ( <i>Festuca rubra</i> var. <i>rubra</i> )  <u><b>OR</b></u> Hard Fescue ( <i>Festuca trachyphylla</i> )  Perennial Ryegrass ( <i>Lolium perenne</i> )  <u><b>OR</b></u> Redtop ( <i>Agrostis gigantean</i> )  <b>AND ADD THE FOLLOWING LEGUME:</b>  Flatpea ( <i>Lathyrus sylvestris</i> )	Navigator II  Beacon, Gotham, Spartan II, Sword Blazer (II), Pennfine  Streaker  Lathco	20  20  10  1  15	0.46  0.46  0.23  0.02  0.34	E-SP	2-3	B-D	Use creeping red fescue in heavy shade and on moist sites.  Perennial ryegrass and redtop will establish more rapidly than either fescue. Redtop tolerates wet sites better than ryegrass.  Flatpea will suppress woody vegetation. Plant in the spring, or as a dormant seeding in late fall or winter. It must be incorporated into the soil or covered with mulch. It may not be winter-hardy if planted late summer to fall. Caution: Flatpea can spread aggressively, and can be toxic to livestock.



Mix	Recommended Cultivar	Seeding Rate <sup>1</sup>		Soil Drainage Class <sup>2</sup>	Max. Height (in.)	Maint. Level <sup>3</sup>	Remarks
		lb/ac	lb/1,000 ft <sup>2</sup>				
<b>Cool-Season Grass Mixes</b>							
<b>6.</b> Tall Fescue ( <i>Lolium arundinaceum</i> ) (formerly <i>Festuca arundinacea</i> )  Perennial Ryegrass ( <i>Lolium perenne</i> )  <b>PLUS THE FOLLOWING LEGUME:</b>  White Clover ( <i>Trifolium repens</i> )	Recommended turf-types <sup>4</sup>  Blazer (II), Pennfine  Common	40  25  5	0.93  0.57  0.11	  W-SP  	  2-3  	  C-D  	
<b>7.</b> Creeping Red Fescue ( <i>Festuca rubra</i> var. <i>rubra</i> )  Kentucky Bluegrass ( <i>Poa pratensis</i> )	Navigator II  Recommended turf-types <sup>4</sup>	60  15	1.38  0.34	  W-MW  	  1-2  	  C-D  	This mix has good shade tolerance.
<b>8.</b> Tall Fescue ( <i>Lolium arundinaceum</i> ) (formerly <i>Festuca arundinacea</i> )	Recommended turf-types <sup>4</sup>	100	2.3	E-SP	2-3	A-D	Tall fescue produces a dense turf if frequently mowed, but tends to be clumpy if mowed only occasionally. For best results, recommend using a blend of 3 cultivars. Use low-endophyte cultivars in areas where livestock may graze.
<b>9. SELECT ONE SPECIES OF FESCUE:</b> Tall Fescue ( <i>Lolium arundinaceum</i> ) (formerly <i>Festuca arundinacea</i> )  <b>OR</b> Hard Fescue ( <i>Festuca trachyphylla</i> )  <b>AND ADD:</b>  Kentucky Bluegrass ( <i>Poa pratensis</i> )  Perennial Ryegrass ( <i>Lolium perenne</i> )	Recommended turf-types <sup>4</sup>  Beacon, Gotham, Spartan II, Sword  Recommended turf-types <sup>4</sup> Blazer (II), Pennfine	60  40  40  20	1.38  0.92  0.92  0.46	    W-SP  	    2-3  	    A-B  	Good for highly managed athletic fields.  Tall fescue is more suitable for compacted, high use areas and on moist sites.  Hard fescue produces finer-textured turf with more shade tolerance.  Use tall fescue instead of hard fescue for wastewater treatment strips and areas.  For best results, recommend using a blend of 3 cultivars each for tall fescue and Kentucky bluegrass.

Mix	Recommended Cultivar	Seeding Rate <sup>1</sup>		Soil Drainage Class <sup>2</sup>	Max. Height (in.)	Maint. Level <sup>3</sup>	Remarks
		lb/ac	lb/1,000 ft <sup>2</sup>				
<b>Cool-Season Grass Mixes</b>							
<b>10.</b> Orchardgrass ( <i>Dactylis glomerata</i> )	Any	25	0.57				Low maintenance mix that is easy to establish.  Alsike clover can be toxic to horses.  Omit the clovers if using this mix for wastewater treatment strips and areas.
Creeping Red Fescue ( <i>Festuca rubra</i> var. <i>rubra</i> )	Navigator II	10	0.23				
Redtop ( <i>Agrostis gigantea</i> )	Streaker	1	0.02	W-SP	2-3	C-D	
Alsike Clover ( <i>Trifolium hybridum</i> )	Common	3	0.07				
White Clover ( <i>Trifolium repens</i> )	Common	3	0.07				
<b>11.</b> Creeping Red Fescue ( <i>Festuca rubra</i> var. <i>rubra</i> )	Navigator II	30	0.69				
Chewings Fescue ( <i>Festuca rubra</i> ssp. <i>commutata</i> )	Radar	30	0.69				
Kentucky Bluegrass ( <i>Poa pratensis</i> )	Recommended turf-types <sup>4</sup>	20	0.46	E-MW	2-3	B-D	
<b>OPTIONAL ADDITION</b> Rough Bluegrass ( <i>Poa trivialis</i> )	Common	15	0.34				
<b>12.</b> Creeping Red Fescue ( <i>Festuca rubra</i> var. <i>rubra</i> )	Navigator II	25	0.57				Attractive mix of fine fescues and wildflowers for low maintenance conditions. Once well-established, the grasses may tend to outcompete the wildflowers.  Wildflowers are best established by broadcasting and cultipacking on a prepared seedbed. Drilling can be also used, but care must be taken so that seeds are not drilled too deep.  Hydroseeding is not recommended for this mix if wildflowers are used. (They have very small seeds.)
Hard Fescue ( <i>Festuca trachyphylla</i> )	Beacon, Gotham, Spartan II, Sword	25	0.57				
Sheep Fescue ( <i>Festuca ovina</i> )	Common or Bighorn	25	0.57				
<b>PLUS WILDFLOWER MIX:</b>							
Black-eyed Susan ( <i>Rudbeckia hirta</i> )	Common	2	0.05				
Lance-leaved Coreopsis ( <i>Coreopsis lanceolata</i> )	Common	2	0.05	E-MW	2-3	C-D	
Partridge Pea ( <i>Chamaecrista fasciculata</i> )	Common	5	0.11				
<b>OR ADD CLOVER MIX:</b>							
White Clover ( <i>Trifolium repens</i> )	Common	3	0.07				
Red Clover ( <i>Trifolium pretense</i> )	Any	3	0.07				

Mix	Recommended Cultivar	Seeding Rate <sup>1</sup>		Soil Drainage Class <sup>2</sup>	Max. Height (in.)	Maint. Level <sup>3</sup>	Remarks
		lb/ac	lb/1,000 ft <sup>2</sup>				
<b>Cool-Season Grass Mixes</b>							
13. Alkali Saltgrass ( <i>Puccinellia distans</i> )	Fults or Salty	20	0.46				This is the recommended mix for saline sites. Saltgrass will persist only under saline conditions.  For best results, use only the 'Dawson' variety of creeping red fescue. It is a salt-tolerant variety.  Add bentgrass for wetter conditions.
Creeping Red Fescue ( <i>Festuca rubra</i> var. <i>rubra</i> )	Navigator II	15	0.34				
Fowl Meadowgrass ( <i>Poa palustris</i> )	Common	2	0.05	W-P	2-3	B-D	
<b>OPTIONAL ADDITION</b> Creeping Bentgrass ( <i>Agrostis stolonifera</i> )	Seaside	2	0.05				

Notes:

- Seeding Rates: Seeding rates for the warm-season grasses are in pounds of Pure Live Seed (PLS). Actual planting rates must be adjusted to reflect percent seed germination and purity, as tested. Adjustments are usually not needed for the cool-season grasses, legumes, or wildflowers. All legume seeds must be inoculated before planting with the appropriate Rhizobium bacteria. When feasible, scarify hard-seeded legumes scarified to improve germination.
- Soil Drainage Class (refer to the county soil survey for further information):  
E - Excessively Drained; W - Well Drained; MW - Moderately Well Drained; SP - Somewhat Poorly Drained; P - Poorly Drained.
- Maintenance Level:  
A - Intensive mowing (every 2-4 days), fertilization, lime, insect and weed control, and watering (examples: high maintenance lawns and athletic fields).  
B - Frequent mowing (every 4-7 days), occasional fertilization, lime, pest control, and watering (examples: residential, school, and commercial lawns).  
C - Periodic mowing (every 7-14 days), occasional fertilization and lime (examples: residential lawns, parks).  
D - Infrequent or no mowing, fertilization, or lime after the first year of establishment (examples: wildlife areas, roadsides, steep banks).
- Turf-type cultivars of tall fescue and Kentucky bluegrass must be selected based on recommendations of the Maryland-Virginia Turfgrass Variety Recommendation Work Group.  
Kentucky Bluegrass – Individual varieties selected must make up not less than 10%, nor more than 35% of the total mixture on a weight basis. All varieties must be certified. Selections can be made from Category I alone or various combinations of Categories I and II. Kentucky bluegrasses listed as “Promising” (Category II below) can account for no more than 35% of the blend by weight).  
Category I – Recommended Kentucky Bluegrass Varieties (65% to 100% of blend by weight). Aries, Blue Bank, Blue Coat, Blue Note, Bolt, Full Back, Hampton, Legend, Midnight, Noble, Skye, and Sudden Impact<sup>3</sup>.  
Category II – Promising Kentucky Bluegrasses (10% to 35% on a weight basis). Aramintha, Barvette HGT, Endurance, Heidi, Keeneland, Mazama, Merlot, NuChicago, Oasis, Skye, and Wildhorse<sup>1</sup> (Wildhorse is only for mixing with tall fescue).  
Tall Fescue – Both recommended and promising varieties can be used in the VCIA Sod Certification Program.  
Category I – Recommended Tall Fescue Varieties (90% to 100% on a weight basis). Annapolis, Avenger II, Black Tail, Bladerunner II<sup>4</sup>, Bullseye, Catalyst, Dakota<sup>4</sup>, Embrace, Falcon V, Firecracker SLS<sup>2</sup>, Guardian 41<sup>4</sup>, Gazelle II, Golconda<sup>4</sup>, Gold Medallion, GTO, Hemi<sup>3</sup>, Inferno, Integrity, Justice, Leonardo<sup>2</sup>, Maestro, Michelangelo, Mustang 4, Penn RK4, Persuasion<sup>4</sup>, Raptor III, Rebel IV, Reflection, Regenerate, Rendition RX, Rockwell, Saltillo, Screamer LS, Speedway<sup>4</sup>, Spyder LS, SR 8650<sup>4</sup>, Sunset Gold, Supersonic, Technique, Temple, Thor, Titanium 2LS, Titan Rx, Turbo, Turbo RZ<sup>4</sup>, Xtender, and Xtremegreen.  
Category II – Promising tall fescue varieties (may be 90% to 100% of the mixture on a weight basis): 4th Millennium, Amity, Bloodhound, Crossfire 4, Fantasia, Fayette, Fesnova, Firebird 2, Firewall, Foxhound, Grande 3, Hot Rod, Houndog 8, Hover, Maestro, Nightcrawler, Paramount, Persuasion, Rebel V, Rebounder, Rambler 2 SRP, Rhizing Moon, Rowdy, Swagger, Terrano, Traverse II SRP, Trinity, Turfway, Valkyrie LS, and Wichita.  
Kentucky bluegrass varieties recommended for mixing with tall fescue sod to enhance sod strength (up to 10% of the seed mixture by weight): All cultivars in Categories I and II above. Note recommendation of hybrid bluegrasses as promising varieties for mixtures with turf-type tall fescues in the traditionally warmer climates of Virginia.  
Varieties marked with superscript notations denote the following:
  - To be considered for removal in 2018 due to declining performance relative to other varieties.
  - To be considered for removal in 2018 due to declining seed quality.
  - To be considered for removal in 2018 due to the absence of recent testing of certified seed lots in MD and VA.
  - To be considered for removal in 2018 due to lack of recent testing in MD and VA.

### Sod grass

Use sod grass to provide quick cover on disturbed areas (2:1 grade or flatter).

1. Class of turfgrass sod must comply with the grass varieties listed in Table 2.7. Make sod labels available to the job foreman and inspector.
2. Machine cut sod at a uniform soil thickness of  $\frac{3}{4}$  inches, plus or minus  $\frac{1}{4}$  inches, at the time of cutting. Measurement for thickness must exclude top growth and thatch. Individual pieces of sod must be cut to the supplier's width and length. Maximum allowable deviation from standard widths and lengths is 5%. Broken pads and torn or uneven ends will not be acceptable.
3. Standard size sections of sod must be strong enough to support their own weight and retain their size and shape when suspended vertically with a firm grasp on the upper 10% of the section.
4. Do not harvest or transplant sod when moisture content (excessively dry or wet) may adversely affect its survival.
5. Harvest, deliver, and install sod within a period of 36 hours. Sod not transplanted within this period must be approved by an agronomist or soil scientist prior to its installation.

### Planting Dates

The recommended planting dates for permanent cover can be found in Table 2.8.

**Table 2.8 Recommended Planting Dates for Permanent Cover**

Type of Plant Material	Planting Dates
Seeds - Cool-Season Grasses (includes mixes with forbs and/or legumes)	Feb 15 to Apr 30 Aug 15 to Oct 31 Nov 1 to Nov 30 <sup>3</sup>
Seeds - Warm-Season/Cool-Season Grass Mixes (includes mixes with forbs and/or legumes)	Feb 15 to Apr 30 <sup>4</sup> May 1 to May 31 <sup>5</sup>
Sod - Cool-Season	Feb 15 to Apr 30 May 1 to Sep 30 <sup>5</sup> Oct 1 to Dec 1 <sup>5,6</sup>

## Notes:

1. When seeding toward the end of the listed planting dates, or when conditions are expected to be less than optimal, select an appropriate nurse crop from Table 2.4 Temporary Seeding for Site Stabilization and plant together with the permanent seeding mix.
2. When planted during the growing season, most of these materials must be purchased and kept in a dormant condition until planting.
3. Recommend adding a nurse crop, as noted above, if planting during this period.
4. Warm-season grasses need a soil temperature of at least 50 degrees F in order to germinate. If soil temperatures are colder than 50 degrees, or moisture is not adequate, the seeds will remain dormant until conditions are favorable. In general, planting during the latter portion of this period allows more time for weed emergence and weed control prior to planting. When selecting a planting date, consider the need for weed control vs. the likelihood of having sufficient moisture for later plantings, especially on droughty sites.
5. Additional planting dates during which supplemental watering may be needed to ensure plant establishment.
6. Frequent freezing and thawing of wet soils may result in frost-heaving of materials planted in late fall, if plants have not sufficiently rooted in place. Sod usually needs 4 to 6 weeks to become sufficiently rooted.

Minimum Soil Criteria

Minimum soil conditions required for permanent vegetative establishment include the following:

1. Soil pH must be between 6.0 and 7.0.
2. Soluble salts must be less than 500 parts per million (ppm).
3. The soil must contain less than 40% clay but enough fine grained material (> 30% silt plus clay) to provide the capacity to hold a moderate amount of moisture. As an exception, it is acceptable to plant lovegrass or sercia lespedeza in sandy soil (< 30% silt plus clay).
4. Soil must contain 1.5% minimum organic matter by weight.
5. Soil must contain sufficient pore space to permit adequate root penetration.
6. If these conditions cannot be met by soils on site, topsoil must be added as required in Section 2.6 Topsoiling.

Soil Amendments (Fertilizer and Lime Specifications)

1. Soil tests must be performed to determine the exact ratios and application rates for both lime and fertilizer on sites with disturbed areas over 5 acres. Soil analysis may be performed by

the University of the District of Columbia or a certified commercial laboratory. Soil samples taken for engineering purposes may also be used for chemical analyses.

2. Fertilizers must be uniform in composition, free flowing, and suitable for accurate application by approved equipment. Manure may be substituted for fertilizer with prior approval from DOEE. Deliver all fertilizers to the site fully labeled per applicable laws and bear the name, trade name or trademark, and warranty of the producer.
3. Lime materials must be ground limestone (hydrated or burnt lime may be substituted) containing at least 50% total oxides (calcium oxide plus magnesium oxide). Limestone must be ground to such fineness that at least 50% will pass through a #100 mesh sieve and 98% to 100% will pass through a #20 mesh sieve.

### **2.10.5 Construction Specifications**

#### Site Preparation

1. Install erosion and sediment control structures (either temporary or permanent) such as diversions, grade stabilization structures, berms, waterways, or sediment control basins.
2. Perform all grading operations at right angles to the slope. Final grading and shaping is not usually necessary for temporary seeding.
3. Schedule required soil tests to determine soil amendment composition and application rates for sites having disturbed area over 5 acres.
4. Distribute lime and fertilizer evenly and incorporate them into the top 3 to 5 inches of soil by disking or other suitable means.
5. Where the subsoil is either highly acidic or composed of heavy clays, spread ground limestone at the rate of 4 to 8 tons per acre (200 to 400 pounds per 1,000 square feet) prior to the placement of topsoil.

#### Seedbed Preparation

1. Temporary Seeding
  - (a) Seedbed preparation must consist of loosening soil to a depth of 3 to 5 inches by means of suitable agricultural or construction equipment, such as disc harrows or chisel plows or rippers mounted on construction equipment. After the soil is loosened, do not roll or drag smooth but leave in the roughened condition. Track sloped areas (greater than 3:1) leaving the surface in an irregular condition with ridges running parallel to the contour of the slope.
  - (b) Apply fertilizer and lime as prescribed on the plans.
  - (c) Incorporate lime and fertilizer into the top 3 to 5 inches of soil by disking or other suitable means.
2. Permanent Seeding – Maintain areas previously graded in conformance with the drawings in a true and even grade, then scarified or otherwise loosened to a depth of 3 to 5 inches to permit bonding of the topsoil to the surface area and to create horizontal erosion check slots to prevent topsoil from sliding down a slope.

Apply soil amendments as per soil test or as included on the plans.

Mix soil amendments into the top 3 to 5 inches of topsoil by disking or other suitable means. Rake lawn areas to smooth the surface, remove large objects like stones and branches, and ready the area for seed application. Where site conditions will not permit normal seedbed preparation, loosen surface soil by dragging with a heavy chain or other equipment to roughen the surface. Track steep slopes (steeper than 3:1) by a dozer leaving the soil in an irregular condition with ridges running parallel to the contour of the slope. The top 1 to 3 inches of soil should be loose and friable. Seedbed loosening may not be necessary on newly disturbed areas.

3. Methods of Seeding – Apply seed uniformly with hydroseeder (slurry includes seed, fertilizer and mulch), broadcast or drop seeder, or a cultipacker seeder.

(a) Hydroseeding

- i) If fertilizer is being applied at the time of seeding, the application rates will not exceed the following: nitrogen, maximum of 100 pounds per acre total of soluble nitrogen;  $P_2O_5$  (phosphorous), 200 pounds per acre;  $K_2O$  (potassium), 200 pounds per acre.
- ii) Lime – Use only ground agricultural limestone, (up to 3 tons per acre may be applied by hydroseeding). Normally, not more than 2 tons per acre are applied by hydroseeding at any one time. Do not use burnt or hydrated lime when hydroseeding.
- iii) Seed and fertilizer must be mixed on site and seeding must be done immediately and without interruption.
- iv) Fiber mulch may be incorporated into the hydroseeding mixture. Consult Section 2.7 Mulching for standards and specifications for mulch materials.

(b) Dry Seeding – This includes use of conventional drop or broadcast spreaders.

- i) Incorporate seed spread dry into the subsoil at the rates prescribed on the Temporary or Permanent Seeding Summaries or Tables 2.4 or 2.7. The seeded area must then be rolled with a weighted roller to provide good seed to soil contact.
- ii) Where practical, apply seed in two directions perpendicular to each other. Apply half the seeding rate in each direction.

(c) Drill or Cultipacker Seeding – Mechanized seeders that apply and cover seed with soil.

- i) Cultipacking seeders are required to bury the seed in such a fashion as to provide at least ¼ inches of soil covering. Seedbed must be firm after planting.
- ii) Where practical, apply seed in two directions perpendicular to each other. Apply half the seeding rate in each direction.

4. Sod Installation – During periods of excessively high temperature or in areas having dry subsoil, the subsoil must be lightly irrigated immediately prior to laying the sod.

The first row of sod must be laid in a straight line with subsequent rows placed parallel to and tightly wedged against each other. Lateral joints must be staggered to promote more uniform growth and strength. Ensure that sod is not stretched or overlapped and that all joints are butted tight in order to prevent voids, which would cause air drying of the roots.

Wherever possible, lay sod with the long edges parallel to the contour and with staggering joints. Roll and tamp, peg, or otherwise secure sod to prevent slippage on slopes and to ensure solid contact between sod roots and the underlying soil surface.

Immediately water sod following rolling or tamping until the underside of the new sod pad and soil surface below the sod are thoroughly wet. Complete the operations of laying, tamping and irrigating for any piece of sod within eight hours.

5. Incremental Stabilization – Cut Slopes

Dress, prepare, seed, and mulch all cut slopes as the work progresses. Excavate and stabilize slopes in equal increments not to exceed 15 feet.

The construction sequence is as follows (refer to Figure 2.1):

- (a) Excavate and stabilize all temporary swales, side ditches, or berms that will be used to convey runoff from the excavation.
- (b) Perform phase 1 excavation, dress, and stabilize.
- (c) Perform phase 2 excavation, dress, and stabilize. Overseed phase 1 areas as necessary.
- (d) Perform final phase excavation, dress, and stabilize. Overseed previously seeded areas as necessary.

Note: Once excavation has begun the operation should be continuous from grubbing through the completion of grading and placement of topsoil (if required) and permanent seed and mulch. Any interruptions in the operation or completing the operation out of the seeding season will necessitate the application of temporary stabilization.



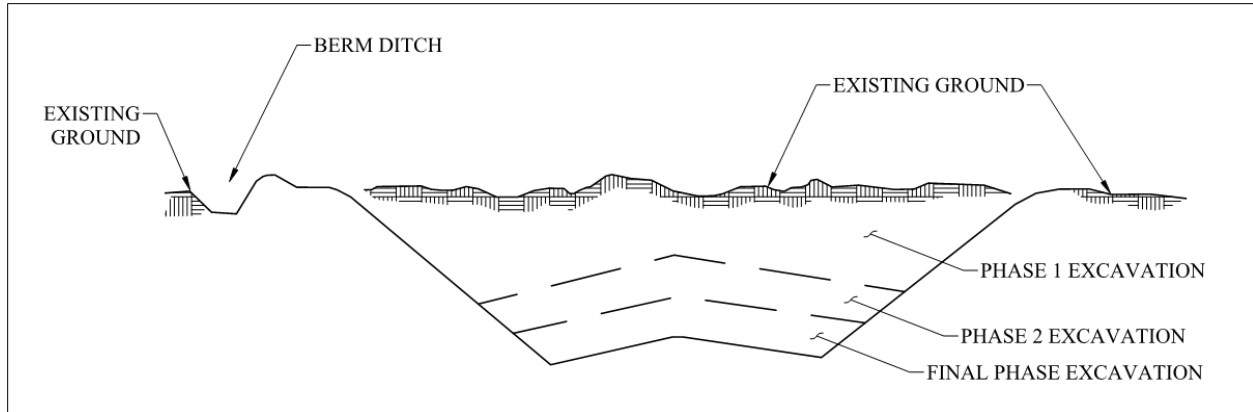

**Figure 2.1 Incremental stabilization – cut.**

## 6. Incremental Stabilization of Embankments – Fill Slopes

Construct embankments in lifts as prescribed on the plans.

Immediately stabilize slopes when the vertical height of the multiple lifts reaches 15 feet, or when the grading operation ceases as prescribed in the plans.

At the end of each day, construct temporary berms and pipe slope drains along the top edge of the embankment to intercept surface runoff and convey it down the slope in a non-erosive manner to a sediment trapping device.

The construction sequence is as follows (refer to Figure 2.2):

- (a) Excavate and stabilize all temporary swales, side ditches, or berms that will be used to divert runoff around the fill. Construct Slope Silt Fence on low side of fill as shown in Figure 2.2, unless other methods shown on the plans address this area.
- (b) Place phase 1 embankment, dress and stabilize.
- (c) Place phase 2 embankment, dress and stabilize.
- (d) Place final phase embankment, dress and stabilize. Overseed previously seeded areas as necessary.

Note: Once the placement of fill has begun the operation should be continuous from grubbing through the completion of grading and placement of topsoil (if required) and permanent seed and mulch. Any interruptions in the operation or completing the operation out of the seeding season will necessitate the application of temporary stabilization.

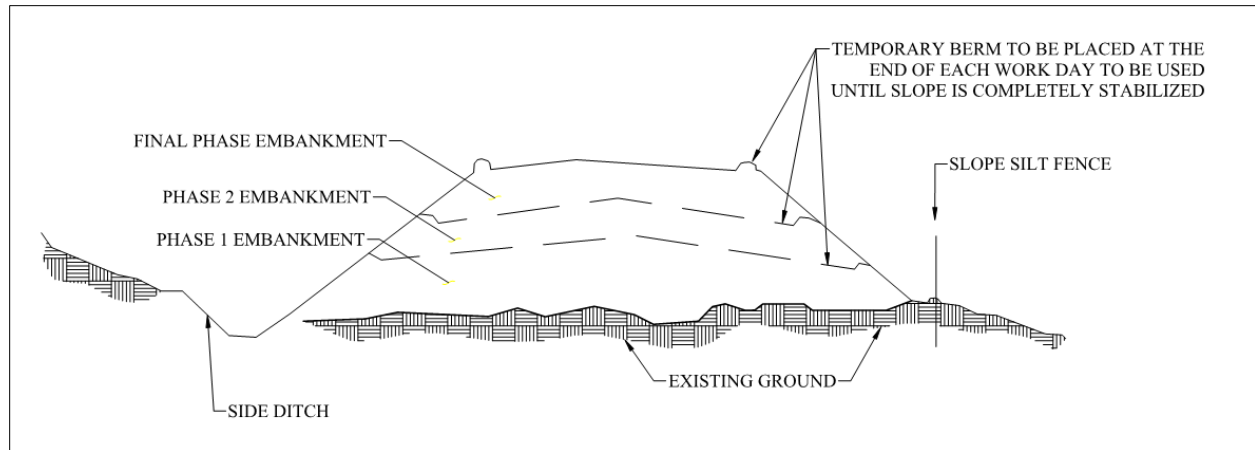

**Figure 2.2 Incremental stabilization – fill.**

### 2.10.6 Maintenance

#### Grass Maintenance

1. Inspect all seeded areas for failures and make necessary repairs, replacements, and reseedings within the planting season.
2. Once the vegetation is established, the site must have 95% ground cover to be considered adequately stabilized.
3. If the stand provides less than 40% ground coverage, reestablish following original lime, fertilizer, seedbed preparation and seeding recommendations.
4. If the stand provides between 40% and 94% ground coverage, overseeding and fertilizing using half of the rates originally applied may be necessary.
5. Maintenance fertilizer rates for permanent seedings are shown in Table 2.9.

**Table 2.9 Maintenance Fertilization for Permanent Seeding**

Seeding Mixture	Type	Seeding Rate		Time	Mowing
		lb/ac	lb/1,000 ft <sup>2</sup>		
Tall fescue makes up 70% or more of cover.	10-10-10	500	11.5	Yearly or as needed.	Not closer than 3 inches, if occasional mowing is desired.
	30-10-10	400	9.2	Fall	
Birdsfoot trefoil.	0-20-0	400	9.2	Spring, the year following establishment, and every 4 to 5 years, after.	Mow no closer than 2 inches.
Fairly uniform stand of tall fescue or birdsfoot trefoil.	5-10-10	500	11.5	Fall, the year following establishment, and every 4 to 5 years, after.	Not required, no closer than 4 inches in the fall after seed has matured.
Weeping lovegrass fairly uniform plant distribution.	5-10-10	500	11.5	Spring, the year following establishment, and every 3 to 4 years, after.	Not required, not closer than 4 inches in fall after seed has matured.
Red & chewings fescue, Kentucky bluegrass, hard fescue mixtures.	20-10-10	250	5.8	September, 30 days later.	Mow no closer than 2 inches for red fescue and Kentucky bluegrass, 3 inches for fescue.
		100	2.3	December, May 20, June 30, if needed.	
Red & chewings fescue, Kentucky bluegrass, hard fescue mixtures.	20-10-10	250	5.8	September, 30 days later.	Mow no closer than 2 inches for red fescue and Kentucky bluegrass, 3 inches for fescue.
		100	2.3	December, May 20, June 30, if needed.	

### Sod Maintenance

1. In the absence of adequate rainfall, perform watering daily or as often as necessary during the first week and in sufficient quantities to maintain moist soil to a depth of 4 inches. Water during the heat of the day to prevent wilting.
2. After the first week, sod watering is required as necessary to maintain adequate moisture content.
3. Do not attempt the first mowing of sod until the sod is firmly rooted. Do not remove more than a third of the grass leaf by the initial cutting or subsequent cuttings. Maintain grass height between 2 to 3 inches unless otherwise specified.

## **2.11 Polyacrylamide**

### **2.11.1 Definition**

The generic term polyacrylamide (PAM) refers to long-chain organic polymers. There are hundreds of specific PAM formulations, and all have unique properties that depend on polymer chain length and number and kinds of functional group substitutions along the chain. PAMs are classified according to their molecular weight and ionic charge and are available in solid, granular, liquid, or emulsion forms.

### **2.11.2 Purpose**

Polyacrylamides enhance particle cohesion, stabilizing soil structure against shear-induced detachment and transport in runoff. In a soil application, PAM aggregates soil particles and increases pore space and infiltration capacity, resulting in reduced runoff. These larger particle aggregates are less susceptible to raindrop and scour erosion, thus reducing the potential to mobilize sediments.

### **2.11.3 Conditions Where Practice Applies**

PAM is intended for use on areas that contain high amounts of fine silt, clay, or colloidal soils. Because of ease in application, PAM is well suited as a short-term erosion prevention BMP, especially for areas with limited access or steep slopes that hinder personnel from applying other cover materials. Use PAM in conjunction with other sediment and erosion control BMPs, and not in place of other BMPs.

PAM can be applied to the following areas:

- Rough graded soils that will be inactive for a period of time.
- Final graded soils before application of final stabilization (e.g., paving, planting, mulching).
- Temporary haul roads prior to placement of crushed rock surfacing.
- Compacted soil road base.
- Construction staging, materials storage, and layout areas.
- Soil stockpiles.
- Areas that will be mulched.
- Newly excavated traps and basins bottom and side slopes to help prevent turbidity from inflow of runoff into the traps and basins.

PAM must only be applied on areas that ultimately drain to a preconstructed sediment trap or basin prior to introduction to surface waters. It is highly encouraged to use PAM in conjunction with the other BMPs specified in the approved ESC Plan.

### 2.11.4 Design Criteria

#### Material

Only anionic PAM and anionic PAM mixtures that comply with the following criteria may be used. The criteria listed below are generally included on the product label and/or Safety Data Sheet (SDS). The specific PAM copolymer formulation must be anionic (negatively charged), with a charge density of 8% to 35% by weight (15% to 18% is typical). Cationic PAM must not be used in any application because of known aquatic toxicity problems.

- Ultra-high molecular weight of 6–24 mg/mole (preferably 12–15 mg/mole).
- Water soluble, “linear,” or “non-cross linked.”
- The highest-grade drinking water grade PAM certified for compliance with ANSI/NSF Standard 60 and FDA residual acrylamide monomer (AMD) with limits of 0.05% for drinking water and food treatment.
- Non-combustible.
- Does not change soil pH.
- Expiration date included.

Anionic PAM must be accompanied by SDS and toxicity information from the manufacturer confirming that the anionic PAM product and any required additives are non-toxic to aquatic biota (acute and chronic toxicity results using EPA protocols approved under the Clean Water Act at 40 CFR 136).

Anionic PAM must also be accompanied by manufacturer’s written instructions to ensure proper product and site preparation, application, maintenance/re-application, storage, and safety, in accordance with Occupational Health and Safety Administration and other applicable guidelines.

#### Site-Specific Testing and Instructions

Users must obtain site-specific soil and water testing and guidance from a qualified manufacturer to ensure that a selected PAM product, additives, and application scheme are tailored to site-specific soil characteristics (type, aggregate size, organic content, and ion content), topography, hydrology, and type of erosion targeted. Manufacturers generally provide this service at no cost. Provide the final site-specific specifications and material specifications to DOEE in the ESC Plan.

### 2.11.5 Construction Specifications

#### Application Conditions

PAM must always be applied above a preconstructed sediment trap or basin inflow structure and never be applied directly to slopes that flow directly into a wetland or waters of the District.

#### General Considerations

- PAM may be applied in dissolved form with water, or it may be applied in dry, granular, or powdered form.

- PAM may not be applied within 25 feet of any natural waterbodies.
- PAM will work when applied to saturated soil but is not as effective as applications to dry or damp soil. PAM is not recommended for application on surfaces of pure sand or gravels with no fines or on snow-covered surfaces.
- Keep the granular PAM supply out of the sun. Granular PAM loses its effectiveness in three months after exposure to sunlight and air.
- PAM, combined with water, is very slippery and can be a safety hazard. Care must be taken to prevent spills of PAM powder onto paved surfaces. During an application of PAM, prevent over spray from reaching pavement, as pavement will become slippery. If PAM powder gets on skin or clothing, wipe it off with a rough towel rather than washing with water.

#### Preferred Application Method

1. The specific PAM formulation and rate of application is unique to each site depending upon the soil types present. Prior to the commencement of site grading, take soil samples and forward to an experienced PAM consultant for laboratory analysis. The PAM consultant should recommend the type of PAM to be utilized, and the application rate and methodologies to be employed. Higher concentrations of PAM than those recommended by the PAM consultant do not provide any additional effectiveness. Forward the PAM recommendations to DOEE for approval.
2. Keep a record of the application, including the date of application, product type, weather conditions, method of application, and the name of the applicator, on site.
3. Do not add water to powdered PAM. Add PAM powder slowly to water to the desired concentration and mix for 3 to 5 minutes. If water is added to PAM, globs may form that can clog dispensers—this indicates incomplete dissolving of the PAM and, therefore, increases the risk of under-application.
4. The application method used should provide uniform coverage to the target area while avoiding drift to non-target areas, especially paved areas.
5. Including tackifiers, mulch, seed, and fertilizer in the final PAM mixture is recommended to improve performance and provide additional permanent protection beyond the useful life of the PAM. However, PAM must always be the final additive to the mixture.
6. Immediately prepare the PAM mixture prior to application as effectiveness decreases if too much time passes between mixing and application.
7. Marking with tracer or colorant to visually track application is recommended.
8. Procedures for application must ensure uniform coverage to the target area and avoid drift to non-target areas.
9. Confirm that the area where PAM is applied is above a preconstructed sediment trap or basin inflow structure.

### 2.11.6 Maintenance

Inspect BMPs prior to forecasted rain, daily during extended rain events, after rain events, weekly during the rainy season, and at two-week intervals during the non-rainy season. PAM may be reapplied in accordance with manufacturer's instructions to disturbed areas after a 48-hour period. Reapplication is not required unless PAM treated soil is disturbed or unless turbidity levels show the need for an additional application. If PAM treated soil is left undisturbed, a reapplication may be necessary after 6–8 weeks. More PAM applications may be required for steep slopes, silty and clayey soils (USDA Classification Type "C" and "D" soils), long grades, and high precipitation areas. When PAM is applied first to bare soil and then covered with straw or mulch, a reapplication may not be necessary for several months.

Discharges from PAM treated areas must be monitored for non-visible pollutants. Maintain all equipment to provide the application rates recommended by the manufacturer. Rinse all equipment used to mix and apply PAM thoroughly with water to avoid formation of residues. Discharge rinse water to soil areas where PAM stabilization may be helpful. If using a liquid application system, pump a surfactant through the injection system before and after injecting concentrated liquid PAM into sprinkler irrigation systems to help prevent valves and tubing from clogging.

PAM may enhance precipitation of fine sediments in downstream pipes, channels, and detention basins. Accordingly, periodically inspect these structures and remove sediment when it exceeds 10% of the structure's mean depth or in accordance with the clean out schedule recommended for the particular measure. Reuse or dispose of excess material as well as recovered sediments containing PAM in accordance with District and federal regulations.





## Chapter 3 Sediment Barriers and Filters

### 3.1 Silt Fence

#### 3.1.1 Definition

Temporary barriers of woven geotextile fabric used to intercept, reduce velocity, and filter surface runoff from disturbed areas.

#### 3.1.2 Purpose

Silt fences intercept sediment-laden sheet flow runoff so that deposition of the transported sediment can occur. Silt fences can be used to intercept sheet flow only. Do not use silt fence as velocity checks in ditches or swales, or place where it will intercept concentrated flow.

#### 3.1.3 Conditions Where Practice Applies

Silt fence is limited to intercepting sheet flow runoff from limited distances according to slope. Silt fence provides filtering and velocity dissipation to promote gravity settling of sediments.

#### 3.1.4 Design Criteria

1. Use silt fence with caution in areas of rocky soils that may prevent full and uniform depth of anchoring of the barrier.
2. Place silt fence parallel to contours, and extend the ends at least 5 horizontal feet upslope at 45-degree angles relative to the main fence alignment to prevent runoff from flowing around the ends of the silt fence.
3. The length of flow contributing to silt fences, and fence length, must conform to the following:

**Table 3.1 Silt Fence Slope Length and Fence Length Constraints**

Slope Steepness	Slope Length (maximum) (feet)	Silt Fence Length (maximum) (feet)
Flatter than 50:1 (2 %)	unlimited	unlimited
> 50:1 to 10:1 (2% to 10%)	125	1,000
> 10:1 to 5:1 (10% to 20%)	100	750
> 5:1 to 3:1 (20% to 33%)	60	500
> 3:1 to 2:1 (33% to 50%)	40	250
> 2:1 (> 50%)	20	125

4. In areas of less than 2% slope and sandy soils (USDA general classification system, soil class A), maximum slope length and silt fence length will be unlimited. In these areas, a silt fence may be the only perimeter control required.
5. When and where feasible, place silt fence 8 feet past the toe of fill slopes on level ground or as far up to 8 feet as site constraints allow. This allows slowing of runoff and greater volume of settled sediment behind silt fence.
6. Downslope from the silt fence must be undisturbed ground.

### 3.1.5 Construction Specifications

1. Fence posts must be a minimum of 36 inches long driven 16 inches minimum into the ground. Wood posts must be of sound quality hardwood with 1½ inches minimum width when square cut or 1¾ inches minimum diameter when round. Steel posts must be standard T or U section weighing not less than 1 pound per linear foot.
2. Fasten geotextile securely to each fence post with wire ties or staples at top and mid-section. Geotextile must meet the following requirements (Geotextile Class F):

**Table 3.2 Physical Properties of Silt Fence Geotextile**

Property	Value	Test Method
Tension Strength	50 lb/in. (minimum)	ASTM D-4595
Tensile Modulus	20 lb/in. (minimum)	ASTM D-4595
Flow Rate	0.3 gal/ft <sup>2</sup> /minute (maximum)	ASTM D-5141
Filtering Efficiency	75% (minimum)	ASTM D-5141

3. Where ends of geotextile fabric come together, overlap, fold, and staple them to prevent sediment bypass.

### 3.1.6 Maintenance

Inspect silt fence after each rainfall event, at least daily during sustained rainfall events, and maintain when bulges occur or when sediment accumulation reaches 30% of the fabric height.

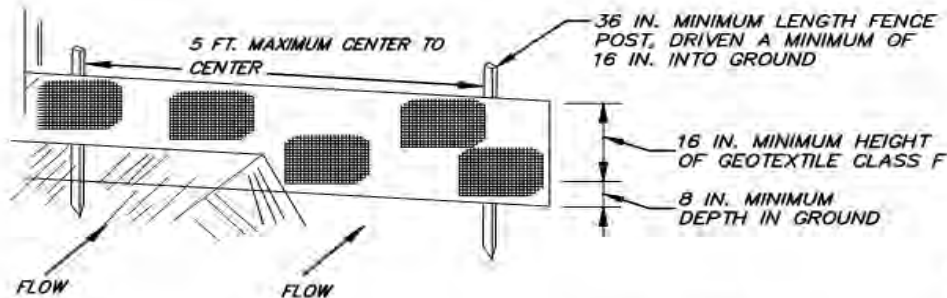

**PERSPECTIVE VIEW**

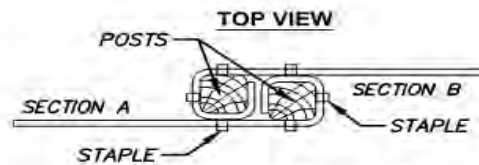

**JOINING TWO ADJACENT SILT FENCE SECTIONS**

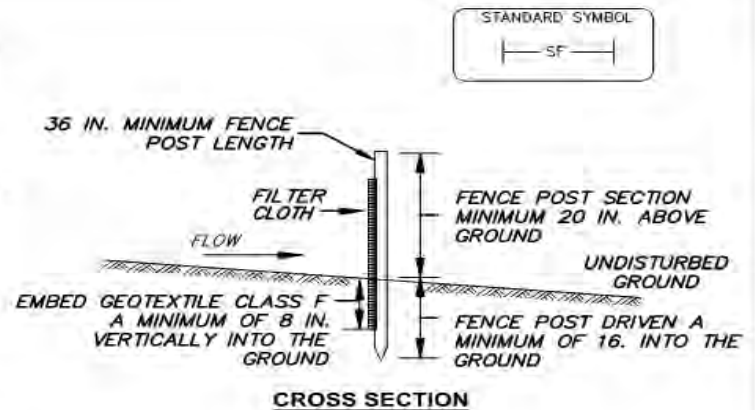

**CONSTRUCTION SPECIFICATIONS**

1. FENCE POSTS MUST BE A MINIMUM OF 36 IN. LONG DRIVEN 16 IN. MINIMUM INTO THE GROUND. WOOD POSTS MUST BE OF SOUND QUALITY HARDWOOD WITH 1-1/2 IN. MINIMUM WIDTH WHEN SQUARE CUT, OR 1-3/4 IN. MINIMUM DIAMETER WHEN ROUND. STEEL POSTS MUST BE STANDARD T OR U SECTION WEIGHING NOT LESS THAN 1.00 POUND PER LINEAR FOOT.
  2. FASTEN GEOTEXTILE SECURELY TO EACH FENCE POST WITH WIRE TIES OR STAPLES AT TOP AND MID-SECTION. GEOTEXTILE MUST MEET THE FOLLOWING REQUIREMENTS (GEOTEXTILE CLASS F):
- | PROPERTY             | VALUE                                  | TEST METHOD |
|----------------------|--|-------------|
| TENSILE STRENGTH     | 50 LBS/IN (MIN.)                       | ASTM D-4595 |
| TENSILE MODULUS      | 20 LBS/IN (MIN.)                       | ASTM D-4595 |
| FLOW RATE            | 0.3 GAL/FT <sup>2</sup> /MINUTE (MAX.) | ASTM D-5141 |
| FILTERING EFFICIENCY | 75% (MIN.)                             | ASTM D-5141 |
3. WHERE ENDS OF GEOTEXTILE FABRIC COME TOGETHER, OVERLAP, FOLD, AND STAPLE THEM TO PREVENT SEDIMENT BYPASS.
  4. INSPECT SILT FENCE AFTER EACH RAINFALL EVENT, AT LEAST DAILY DURING SUSTAINED RAINFALL EVENTS, AND MAINTAIN WHEN BULGES OCCUR OR WHEN SEDIMENT ACCUMULATION REACHES 30% OF THE FABRIC HEIGHT.

DATE	APPR	
REVISED		
ISSUED:		
	REFERENCE	

**SILT FENCE-1**

★ ★ ★ DISTRICT OF COLUMBIA  
DEPARTMENT OF ENERGY & ENVIRONMENT

DWG. NO 301.1

(SOURCE: 011 MARYLAND STANDARDS & SPECIFICATIONS)

**SILT FENCE DESIGN CRITERIA:**

TABLE 3.1: SILT FENCE SLOPE LENGTH AND FENCE LENGTH CONSTRAINTS		
SLOPE STEEPNESS	SLOPE LENGTH (MAXIMUM) (FEET)	SILT FENCE LENGTH (MAXIMUM) (FEET)
FLATTER THAN 50:1 (2%)	UNLIMITED	UNLIMITED
> 50:1 TO 10:1 (2% to 10%)	125	1,000
> 10:1 TO 5:1 (10% to 20%)	100	750
> 5:1 TO 3:1 (20% to 33%)	60	500
> 3:1 TO 2:1 (33% to 50%)	40	250
> 2:1 (> 50%)	20	125

**NOTE:**

- IN AREAS OF LESS THAN 2% SLOPE AND SANDY SOILS (USDA GENERAL CLASSIFICATION SYSTEM, SOIL CLASS A) MAXIMUM SLOPE LENGTH AND SILT FENCE LENGTH WILL BE UNLIMITED. IN THESE AREAS A SILT FENCE MAY BE THE ONLY PERIMETER CONTROL REQUIRED.
- TO AVOID CIRCUMVENTION, EXTEND THE ENDS OF THE SILT FENCE UPSLOPE TO PREVENT WATER AND SEDIMENT FROM FLOWING AROUND THE ENDS OF THE FENCE.

DATE	APPR	
ISSUED:		
		REFERENCE

**SILT FENCE-2**



DISTRICT OF COLUMBIA  
DEPARTMENT OF ENERGY &  
ENVIRONMENT

DWG. NO 301.2

## 3.2 Super Silt Fence

### 3.2.1 Definition

A temporary barrier of woven geotextile fabric over chain link fence used to intercept, reduce velocity, and filter runoff from disturbed areas.

### 3.2.2 Purpose

To reduce runoff velocity and intercept sediment-laden water to allow the deposition of transported sediment to occur. Do not use super silt fence as velocity checks in ditches or swales or placed where it will intercept concentrated flow.

### 3.2.3 Conditions Where Practice Applies

Where the slope steepness or slope length criterion for silt fence cannot be met or where additional protection is warranted such as adjacent to wetlands, streams, or other sensitive areas. The use of super silt fence is based on the slope length and steepness of the contributing drainage area.

### 3.2.4 Design Criteria

1. Super silt fence provides a barrier that can collect and hold debris and soil, preventing the material from entering streams, streets, etc.
2. Place super silt fence parallel to contours, and extend the ends at least 5 horizontal feet upslope at 45-degree angles relative to the main fence alignment to prevent runoff from flowing around the ends of the silt fence. No section of fence should exceed a grade of 5% for a distance of more than 50 feet.
3. Where ends of the geotextile fabric come together, overlap, fold, and staple the ends to prevent sediment bypass.
4. Limits imposed by ultraviolet light stability of the fabric will dictate the maximum period that the silt fence may be used.
5. Length of the flow contributing to super silt fence must conform to the following limitations:

**Table 3.3 Super Silt Fence Slope Length and Fence Length Constraints**

Slope Steepness	Maximum Slope Length (feet)	Maximum Silt Fence Length (feet)
Flatter than 10:1 (10%)	unlimited	unlimited
> 10:1 to 5:1 (10% to 20%)	200	1,500
> 5:1 to 3:1 (20% to 33%)	150	1,000
> 3:1 to 2:1 (33% to 50%)	100	500
> 2:1 (> 50%)	50	250

### 3.2.5 Construction Specifications

1. Fencing must be at least 42 inches in height and constructed in accordance with the latest District Department of Transportation (DDOT) Details for Chain Link Fencing. The DDOT specification for a 6-foot fence must be used, substituting minimum 42-inch fabric and 6-foot length posts. Posts do not need to be set in concrete.
2. Securely fasten chain link fence to the fence posts with wire ties. The lower tension wire, brace and truss rods, drive anchors and post caps are not required except on the ends of the fence.
3. Securely fasten geotextile to the chain link fence with ties spaced every 24 inches at the top and mid-section.
4. Embed geotextile a minimum of 8 inches into the ground.
5. When two sections of geotextile fabric adjoin each other, fold and overlap by 6 inches.
6. Geotextile must meet the following requirements for Geotextile Class F (from Table 3.2):

Property	Value	Test Method
Tension Strength	50 lb/in. (minimum)	ASTM D-4595
Tensile Modulus	20 lb/in. (minimum)	ASTM D-4595
Flow Rate	0.3 gal/ft <sup>2</sup> /minute (maximum)	ASTM D-5141
Filtering Efficiency	75% (minimum)	ASTM D-5141

### 3.2.6 Maintenance

Inspect super silt fence after each rainfall event, at least daily during sustained rainfall events, and maintain when bulges occur or when sediment accumulation reaches 30% of the fabric height.

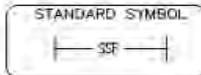

**PERSPECTIVE VIEW**

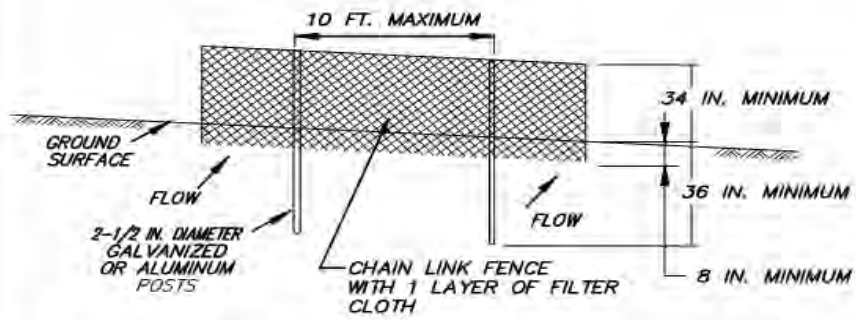

**CROSS SECTION**

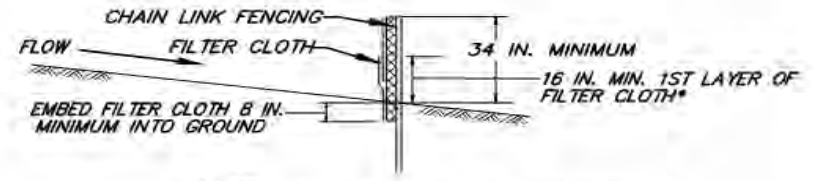

- NOTE:**
- IF MULTIPLE LAYERS ARE REQUIRED TO ATTAIN NECESSARY HEIGHT.
  - FENCE POST SPACING SHALL NOT EXCEED 10 FT. CENTER TO CENTER.

**CONSTRUCTION SPECIFICATIONS**

1. FENCING MUST BE AT LEAST 42 INCHES IN HEIGHT AND CONSTRUCTED IN ACCORDANCE WITH THE LATEST DISTRICT DEPARTMENT OF TRANSPORTATION (DDOT) DETAILS FOR CHAIN LINK FENCING. THE DDOT SPECIFICATION FOR A 6-FOOT FENCE MUST BE USED, SUBSTITUTING MINIMUM 42-INCH FABRIC AND 6-FOOT LENGTH POSTS. POSTS DO NOT NEED TO BE SET IN CONCRETE.
2. SECURELY FASTEN CHAIN LINK FENCE TO THE FENCE POSTS WITH WIRE TIES. THE LOWER TENSION WIRE, BRACE AND TRUSS RODS, DRIVE ANCHORS AND POST CAPS ARE NOT REQUIRED EXCEPT ON THE ENDS OF THE FENCE.
3. SECURELY FASTEN GEOTEXTILE TO THE CHAIN LINK FENCE WITH TIES SPACED EVERY 24 INCHES AT THE TOP AND MID-SECTION.
4. EMBED GEOTEXTILE A MINIMUM OF 8 INCHES INTO THE GROUND.
5. WHEN TWO SECTIONS OF GEOTEXTILE FABRIC ADJOIN EACH OTHER, FOLD AND OVERLAP BY 6 INCHES.
6. GEOTEXTILE MUST MEET THE FOLLOWING REQUIREMENTS FOR GEOTEXTILE CLASS F (FROM TABLE 3.2-SEE BELOW):

PROPERTY	VALUE	TEST METHOD
TENSILE STRENGTH	50 LBS/IN (MIN.)	ASTM D-4595
TENSILE MODULUS	20 LBS/IN (MIN.)	ASTM D-4595
FLOW RATE	0.3 GAL/FT <sup>2</sup> /MINUTE (MAX.)	ASTM D-5141
FILTERING EFFICIENCY	75% (MIN.)	ASTM D-5141

7. INSPECT SUPER SILT FENCE AFTER EACH RAINFALL EVENT, AT LEAST DAILY DURING SUSTAINED RAINFALL EVENTS, AND MAINTAIN WHEN BULGES OCCUR OR WHEN SEDIMENT ACCUMULATION REACHES 30% OF THE FABRIC HEIGHT.

DATE	APPR	
REVISED		
ISSUED:		
	REFERENCE	

**SUPER SILT FENCE-1**

 DISTRICT OF COLUMBIA  
 DEPARTMENT OF ENERGY &  
 ENVIRONMENT

DWG. NO 302.1

SOURCE: 2011 MARYLAND STANDARDS & SPECIFICATIONS

Detail 9 – 302.1 Super Silt Fence - 1







### **3.3 Filter Sock**

#### **3.3.1 Definition**

A filter sock is a tubular casing of geotextile filter fabric filled with compost filter media or comparable filter media (in terms of performance characteristics).

#### **3.3.2 Purpose**

Filter socks are meant to temporarily pond sediment-laden water to allow settling, as well as actively and directly filtering sediment and other pollutants from water that is flowing through them. The filter media specifications may vary based on the pollutants expected to be in the runoff water.

#### **3.3.3 Conditions Where Practice Applies**

Filter socks are an alternative to silt fence and can be used in hard to reach areas, on frozen ground and pavement, and near or over tree roots where trenching would be detrimental. Filter socks are effective when installed perpendicular to sheet or low concentrated flow, and in areas that silt fence is normally considered appropriate.

They are useful on steep and even rocky slopes if sufficient preparation is made to ensure good contact of the sock with the underlying ground along its entire length. They may also be used on pavement as a perimeter control, storm drain inlet protection measure, sediment containment border for temporary stockpiles, and anywhere silt fence on pavement or super silt fence might be prescribed.

Although compost socks can withstand occasional crossing with construction equipment if absolutely necessary, it is not recommended, and any crossing areas must be inspected immediately and repaired or replaced if necessary.

#### **3.3.4 Design Criteria**

1. The effective height of the filter sock and the flow-through rate must be sufficient to keep the design storm flow from over-topping the filter sock, or it will be rendered ineffective.
2. Due to expected slump, the effective height of the filter sock is 80% of the diameter.
3. Maximum slope preceding the filter sock is 50% (2:1).
4. Slope length, steepness, and filter sock design parameters must conform to the specification in Table 3.4.

**Table 3.4 Filter Sock Sizing, Slope Length Constrains, and Flow-Through Rates**

Design Diameter	Effective Height (inches)	Max Slope Length or Sock Spacing, by Slope Steepness (feet)						Hydraulic Flow-Through Rate (gpm/ft)
		< 50:1	50:1 to 20:1	20:1 to 10:1	10:1 to 5:1	5:1 to 3:1	3:1 to 2:1	
8 inches	6.5	300	200	100	50	30	20	7.5
12 inches	9.5	450	300	150	75	45	30	11.3
18 inches	14.5	675	450	225	113	68	45	15.0
24 inches	19	900	600	300	150	90	60	22.5
32 inches	26	1200	800	400	200	120	80	30.0

- Compost must conform to the specifications in Table 3.5, per the DOEE Stormwater Management Guidebook, Appendix J.

**Table 3.5 Compost Material Specifications**

Parameter	Value Range
pH	6.0–8.0
Particle size	100% must pass ½-inch screen
Organic matter content	35% to 65%
Manufactured inert material content	less than 1% by weight
Dry bulk density	40–50 lb/ft <sup>3</sup>

- For long-term or permanent installations, native plant seeds may be added to the compost filler media or applied after installation for vegetative establishment.

### 3.3.5 Construction Specifications

- Before installing, clear all obstructions including rocks, clods, and debris greater than 1-inch that may interfere with proper function of the filter sock.
- Fill sock uniformly with compost or alternate filter media to desired length, with enough material that the socks do not deform.
- Place socks along contours, with the ends turned upslope at 30 to 45 degrees for a length of at least 5 feet to prevent runoff bypass.
- For entrenched installation, backfill mulch or compost on the upstream side of the sock and tamp to prevent undercutting and piping.
- Anchoring stakes must conform to the following list:
  - Minimum 2-inch square cross section hardwood

- (b) Driven at least 12 inches below grade, or 8 inches if in dense clay soils
  - (c) Protrude above filter socks at least 3 inches
  - (d) Driven in at 45-degree angle upslope
  - (e) Spaced at no more than 4 feet apart, or 8 feet apart if the filter sock is entrenched 4 inches in to the ground
6. Do not use entrenched installation on filter socks smaller than 12 inches in diameter.
  7. For hard surface installation, such as on pavement, anchoring may be necessary where straight sections exceed 4 feet. Where the curvature of the filter sock and solid structures such as curbs do not naturally anchor the filter sock, concrete blocks, sandbags, or piles of aggregate must be used for anchoring. Anchors must be placed on the downstream side (opposite the incoming flow) at no more than 4-foot spacing. The ends of the socks must be anchored. Number 1 or number 2 aggregate (refer to Appendix A, Table A.2) must be used for the stone option. Figures 3.1 and 3.2, below, demonstrate applications where block or stone anchoring is not necessary due to physical constraints of the site. When no anchoring is used, the practice must be checked daily, regardless of whether rainfall occurs. Anchored installation is always preferred to non-anchored installation, if possible.
  8. For at-grade inlet protection, filter socks must completely enclose the drain (Figure 3.1). If used as curb inlet protection, the effective height of the filter sock must not be higher than the height of the curb (Figure 3.2); use 8-inch diameter filter sock for standard highway applications.



**Figure 3.1 At-grade inlet protection method.**

Source: Filtrexx



**Figure 3.2 Curb inlet protection method.**

Source: Filtrexx

9. If multiple sections of filter sock are needed for a continuous run, overlap ends of separate sections a minimum 2 feet and stake ends. If the filter socks are placed on a longitudinal slope, the downstream end of the higher filter sock must overlap the upstream end of the lower filter sock. If multiple sections are to be joined, fit beginning of new sock over the end of original sock, overlapping at least 2 feet, and stake the joint where applicable.

10. To reach taller heights, it is possible to stack filter socks such that the bottom layer of filter socks has at least one more row of filter socks than the next layer moving up, and each subsequent layer has one fewer row of socks. For example, a three-layer pile would have at least three adjacent rows, the second layer would have at least two, and the top layer would be a single sock or have no more than one less sock than the second layer.
11. If using filter socks of multiple sizes, larger socks go beneath smaller socks.

### **3.3.6 Maintenance**

Remove sediment when it has accumulated to a depth of half the exposed height of sock and replace sock. Replace filter sock if torn. Reinstall filter sock if undermining or dislodging occurs. Replace clogged filter socks.

For vegetated, permanent or semi-permanent installations, maintain the plants as is appropriate for the species used.

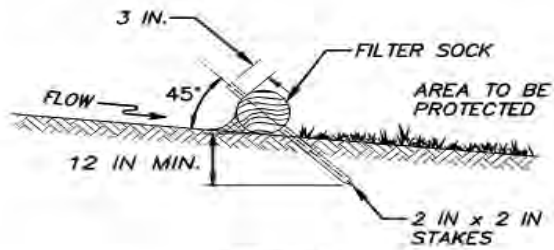

**SECTION**

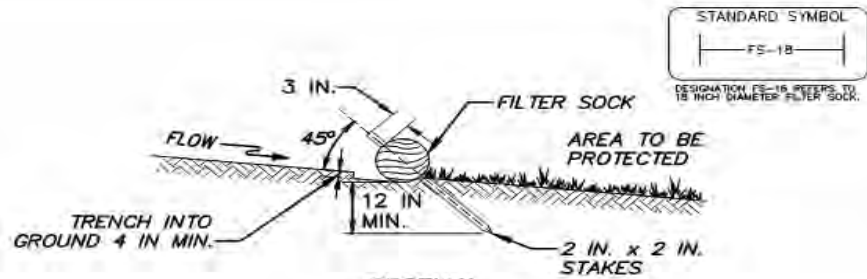

**SECTION**

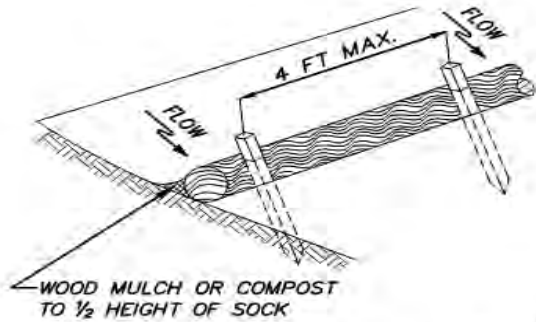

**UNTRENCHED INSTALLATION**

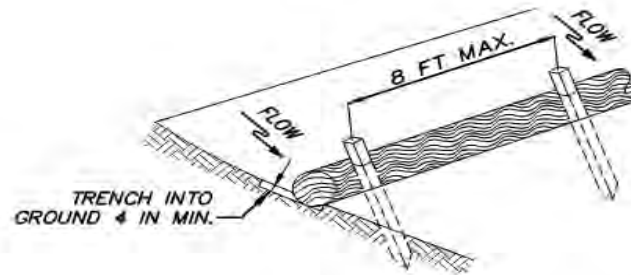

**\*ENTRENCHED INSTALLATION**

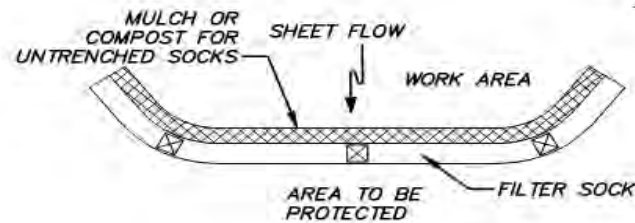

**PLAN VIEW**

**\*NOTE:**  
 • THIS APPLICATION MAY NOT BE USED WITH SOCKS SMALLER THAN 12 IN.

DATE	APPR	
REVISED		
ISSUED:		
	REFERENCE	

**FILTER SOCK - 1**

★ ★ ★ DISTRICT OF COLUMBIA  
 DEPARTMENT OF ENERGY &  
 ENVIRONMENT

DWG. NO 303.1

SOURCE: 2011 MARYLAND STANDARDS & SPECIFICATIONS



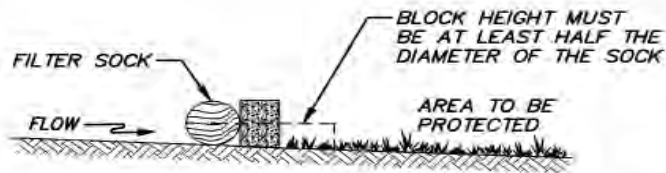

**HARD SURFACE INSTALLATION SECTION**

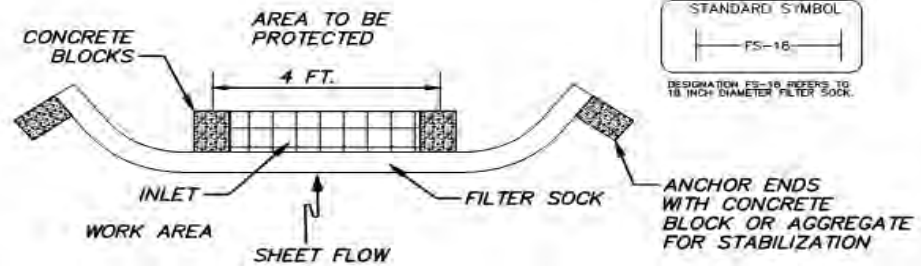

**HARD - SURFACE INSTALLATION PLAN VIEW**

**CONSTRUCTION SPECIFICATIONS**

1. BEFORE INSTALLING, CLEAR ALL OBSTRUCTIONS INCLUDING ROCKS, CLOUDS, AND DEBRIS GREATER THAN 1-INCH THAT MAY INTERFERE WITH PROPER FUNCTION OF THE FILTER SOCK.
2. FILL SOCK UNIFORMLY WITH COMPOST OR ALTERNATE FILTER MEDIA TO DESIRED LENGTH, WITH ENOUGH MATERIAL THAT THE SOCKS DO NOT DEFORM.
3. PLACE SOCKS ALONG CONTOURS, WITH THE ENDS TURNED UPSLOPE AT 30 TO 45 DEGREES FOR A LENGTH OF AT LEAST 5 FEET TO PREVENT RUNOFF BYPASS.
4. FOR UNTRENCHED INSTALLATION, BACKFILL MULCH OR COMPOST ON THE UPSTREAM SIDE OF THE SOCK AND TAMP TO PREVENT UNDERCUTTING AND PIPING.
5. ANCHORING MUST CONFORM TO THE FOLLOWING LIST: (a) MINIMUM 2-INCH SQUARE CROSS SECTION HARDWOOD; (b) DRIVEN AT LEAST 12 INCHES BELOW GRADE, OR 8 INCHES IF IN DENSE CLAY SOILS; (c) PROTRUDE ABOVE FILTER SOCKS AT LEAST 3 INCHES; (d) DRIVEN IN AT 45-DEGREE ANGLE UPSLOPE; (e) SPACED AT NO MORE THAN 4 FEET APART, OR 8 FEET APART IF THE FILTER SOCK IS ENTRENCHED 4 INCHES INTO THE GROUND.
6. DO NOT USE ENTRENCHED INSTALLATION ON FILTER SOCKS SMALLER THAN 12 INCHES IN DIAMETER.
7. FOR HARD SURFACE INSTALLATION, SUCH AS ON PAVEMENT, ANCHORING MAY BE NECESSARY WHERE STRAIGHT SECTIONS EXCEED 4 FEET. SEE DETAIL ABOVE, AND GREATER INSTRUCTION IN THE FILTER SOCK SPECIFICATION. WHEN NO ANCHORING IS USED, THE PRACTICE MUST BE CHECKED DAILY, REGARDLESS OF WHETHER RAINFALL OCCURS. ANCHORED INSTALLATION IS ALWAYS PREFERRED TO NON-ANCHORED INSTALLATION, IF POSSIBLE.
8. FOR AT-GRADE INLET PROTECTION, FILTER SOCKS MUST COMPLETELY ENCLOSE THE DRAIN. IF USED AS CURB INLET PROTECTION, THE EFFECTIVE HEIGHT OF THE FILTER SOCK MUST NOT BE HIGHER THAN THE HEIGHT OF THE CURB; USE 8-INCH DIAMETER FILTER SOCK FOR STANDARD HIGHWAY APPLICATIONS.
9. IF MULTIPLE SECTIONS OF FILTER SOCK ARE NEEDED FOR A CONTINUOUS RUN, OVERLAP ENDS OF SEPARATE SECTIONS A MINIMUM OF 2 FEET AND STAKE ENDS.
10. TO REACH TALLER HEIGHTS, IT IS POSSIBLE TO STACK FILTER SOCKS. SEE SPECIFICATION FOR MORE DETAIL.
11. REMOVE SEDIMENT WHEN IT HAS ACCUMULATED TO A DEPTH OF HALF THE EXPOSED HEIGHT OF SOCK AND REPLACE SOCK. REPLACE FILTER SOCK IF TORN. REINSTALL FILTER SOCK IF UNDERMINING OR DISLODGING OCCURS. REPLACE CLOGGED FILTER SOCKS.
12. FOR VEGETATED, PERMANENT OR SEMI-PERMANENT INSTALLATIONS, MAINTAIN THE PLANTS AS IS APPROPRIATE FOR THE SPECIES USED.

DATE	APPR	
	REVISED	
ISSUED:		
	REFERENCE	

**FILTER SOCK - 2**

 DISTRICT OF COLUMBIA  
 DEPARTMENT OF ENERGY &  
 ENVIRONMENT

DWG. NO 303.2

## 3.4 Organic Filter Berm

### 3.4.1 Definition

Organic filter berms are dikes or berms constructed out of compost and/or wood chips, designed to intercept sheet flow and filter out sediment and other pollutants.

### 3.4.2 Purpose

To slow and filter sediment-laden runoff and maintain sheet flow.

### 3.4.3 Conditions Where Practice Applies

Organic filter berms are appropriate where sheet flow is anticipated, and ground penetration or soil disturbance is undesirable or impossible, making entrenched practices such as silt fences and straw bale dikes not applicable.

### 3.4.4 Design Criteria

1. Filter berms are designed to intercept and discharge runoff as sheet flow. They are not a substitute for earth dikes, and are not designed to divert or convey runoff. They are not to be placed in channels or anywhere channelized or concentrated flow is expected.
2. Any compost used must conform to the following specifications, per the DOEE Stormwater Management Guidebook, Appendix J (from Table 3.5):

Parameter	Value Range
pH	6.0–8.0
Particle size	100% must pass ½-inch screen
Organic matter content	35% to 65%
Manufactured inert material content	less than 1% by weight
Dry bulk density	40–50 lb/ft <sup>3</sup>

3. To minimize damaging velocities and overly fast deposition of sediment, the slope length leading to the filter berms must be limited as follows:

**Table 3.6 Organic Filter Berm Design Constraints**

Average Slope Steepness	Maximum Contributing Slope Length (feet)		Length of Berm (feet)
	Berm A	Berm B	
Flatter than 50:1 (2%)	500	1000	unlimited
> 50:1 to 10:1 (2% to 10%)	250	500	1000
> 10:1 to 5:1 (10% to 20%)	100	200	500
> 5:1 to 3:1 (20% to 33%)	25	50	500

4. The berm design criteria are as follows and also shown in Detail 304.1:

**Table 3.7 Organic Filter Berm Design Criteria**

Design Criteria	Berm A	Berm B
Berm Height (A)	30 inches	42 inches
Berm Top Width (B)	36 inches	48 inches
Side Slopes	2:1 or flatter	2:1 or flatter

### 3.4.5 Construction Specifications

1. Place berm on the contour with ends turned upslope to prevent bypass. Do not exceed grades of 5% along the berm for a distance greater than 50 feet.
2. Use clean wood chips with a minimum size of 1 by 2 inches and maximum size of 3 by 3 inches.
3. Compact and shape material to conform to dimensions specified on the approved plans.
4. Do not place un-chipped tree pieces, brush, or stumps in the berm. Berm must be free of bank projections or other irregularities.
5. The berm may contain up to 50% compost as specified in Design Criterion #2.

### 3.4.6 Maintenance

Maintain line, grade, and cross section. Add wood chips or make other repairs as conditions demand to maintain specified dimensions. Remove accumulated sediment and debris when they reach 25% of berm height, and dispose at permitted site.



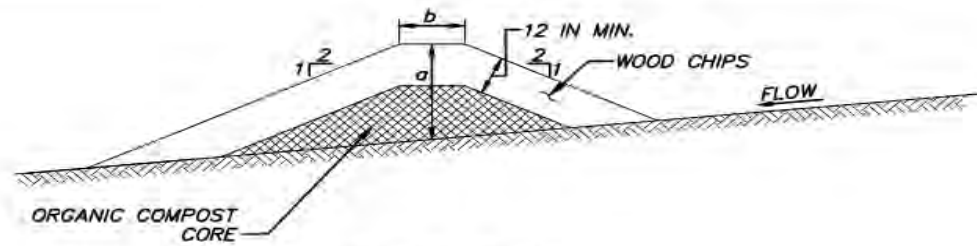

**CROSS SECTION**

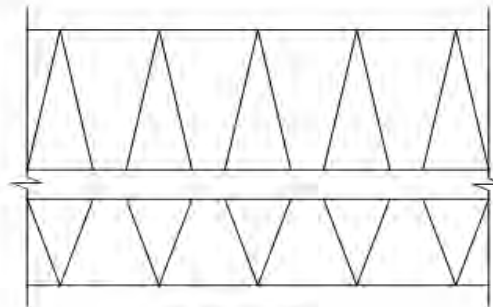

**PLAN VIEW**

DESIGN CRITERIA	BERM A	BERM B
BERM HEIGHT (a)	30 INCHES	42 INCHES
BERM TOP WIDTH (b)	36 INCHES	48 INCHES
SIDE SLOPES	2:1 OR FLATTER	2:1 OR FLATTER

**CONSTRUCTION SPECIFICATIONS**

1. PLACE BERM ON THE CONTOUR WITH ENDS TURNED UPGRADE TO PREVENT BYPASS. DO NOT EXCEED GRADES OF 5 PERCENT ALONG THE BERM FOR A DISTANCE GREATER THAN 50 FEET.
2. CONSTRUCT BERM OF CLEAN WOOD CHIPS A MINIMUM SIZE OF 1 x 2 INCHES AND A MAXIMUM SIZE OF 3 x 3 INCHES.
3. COMPACT AND SHAPE MATERIAL TO CONFORM TO DIMENSIONS SPECIFIED ON THE APPROVED PLAN.
4. DO NOT PLACE UN-CHIPPED TREE PIECES, BRUSH, OR STUMPS IN THE BERM. BERM MUST BE FREE OF BANK PROJECTIONS OR OTHER IRREGULARITIES.
5. THE BERM MAY CONTAIN UP TO 50% COMPOST MATERIAL AS SPECIFIED IN DESIGN CRITERION #2.
6. MAINTAIN LINE, GRADE, AND CROSS SECTION. ADD WOOD CHIPS OR MAKE OTHER REPAIRS AS CONDITIONS DEMAND TO MAINTAIN SPECIFIED DIMENSIONS. REMOVE ACCUMULATED SEDIMENT AND DEBRIS WHEN THEY REACH 25% OF BERM HEIGHT, AND DISPOSE AT PERMITTED SITE.

DATE	APPR
REVISED	
ISSUED:	
	REFERENCE

**ORGANIC FILTER BERM**

 DISTRICT OF COLUMBIA  
 DEPARTMENT OF ENERGY &  
 ENVIRONMENT

DWG. NO 304.1

(SOURCE: 2011 MARYLAND STANDARDS & SPECIFICATIONS)

## 3.5 Straw Bale Dike

### 3.5.1 Definition

Straw bale dikes are temporary barriers of straw or similar material used to intercept and direct surface runoff.

### 3.5.2 Purpose

The straw bale dike intercepts sediment-laden runoff so that deposition of transported sediment can occur.

### 3.5.3 Conditions Where Practice Applies

Straw bale dikes are used as a secondary practice controlling local areas of minor disturbance and/or minor dewatering operations. Use them in areas where there is sheet runoff.

### 3.5.4 Design Criteria

1. The use of straw bale dikes is not recommended as a primary sediment control device. Straw bale dikes clog and deteriorate rapidly, and require frequent maintenance.
2. They cannot be used as velocity checks in swales, or placed where they will intercept concentrated flow.
3. Straw bale dikes can be used only on projects that will be completed within three months.
4. Straw bale dikes must not be used on slopes exceeding 5:1 horizontal to vertical.
5. The length of straw bale dikes must conform to the following limitations:

**Table 3.8 Straw Bale Slope Length and Dike Length Constraints**

Slope Steepness	Slope Length (feet)	Dike Length (feet)
Flatter than 50:1 (2%)	300	500
> 50:1 to 10:1 (2% to 10%)	125	500
> 10:1 to 5:1 (10% to 20%)	100	500

### 3.5.5 Construction Specifications

1. Place bales in a row on the contour with the ends of each bale tightly abutting the adjacent bales.
2. Entrench each bale 4 inches minimum into the soil and place so the bindings are horizontal. Some of the excavated soil must be built up and compacted at the upstream edge of the dike to prevent piping and undercutting.

3. Securely anchor bales in place by either two stakes or rebars driven through the bale 12 inches to 18 inches into the ground. Drive the first stake in each bale toward the previously laid bale at an angle to force the bales together. Drive the stakes flush with the top of the bale.
4. Remove all bales when the site has been stabilized. Grade flush and stabilize the trench where the bales were located.

### **3.5.6 Maintenance**

Immediately inspect straw bale barriers after each rainfall and at least daily during prolonged rainfall events. Redrive the anchoring stakes if they become exposed. Pay close attention to the repair of damaged bales, end runs, and undercutting beneath bales. Necessary repairs to barriers or replacement of bales must be completed promptly.

Remove sediment when the level of deposition reaches approximately one half the height of the barrier. Any sediment deposits remaining in place after the straw bale barrier is no longer required must be dressed to conform to the existing grade, prepared, and seeded.

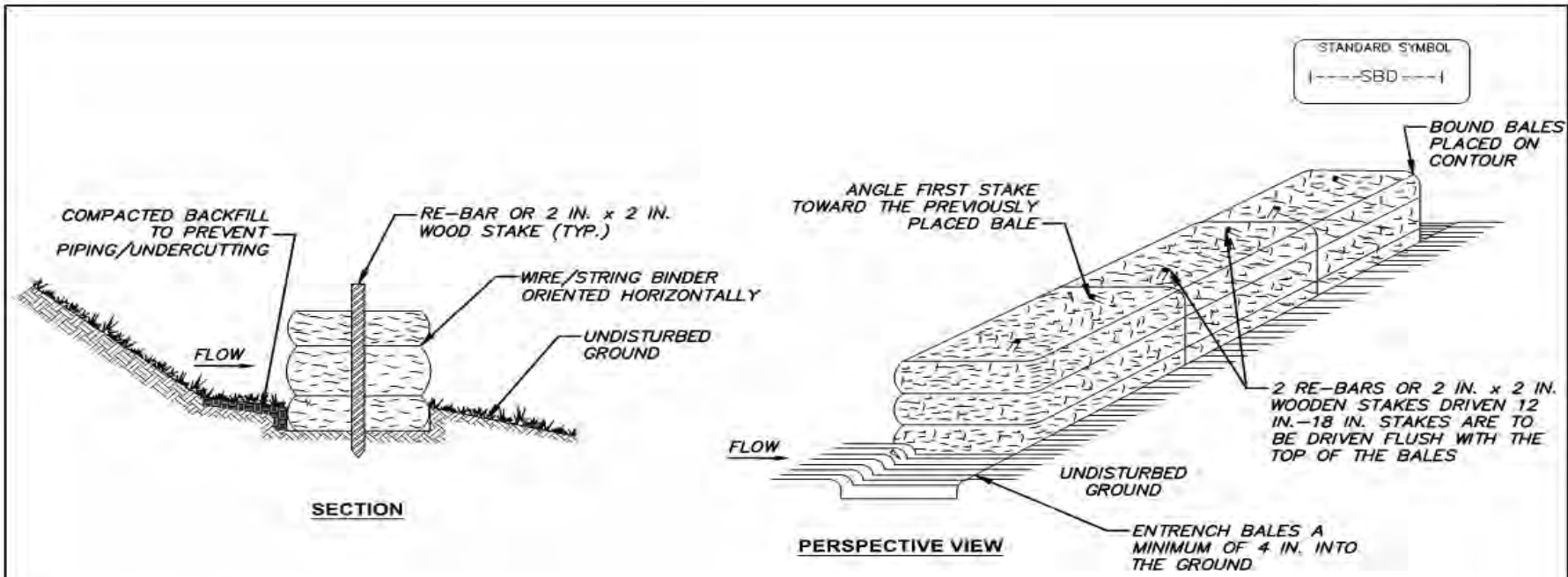

**CONSTRUCTION SPECIFICATIONS**

1. PLACE BALES IN A ROW ON THE CONTOUR WITH THE ENDS OF EACH BALE TIGHTLY ABUTTING THE ADJACENT BALES.
2. ENTRENCH EACH BALE 4 INCHES MINIMUM INTO THE SOIL AND PLACE SO THE BINDINGS ARE HORIZONTAL. SOME OF THE EXCAVATED SOIL MUST BE BUILT UP AND COMPACTED AT THE UPSTREAM EDGE OF THE DIKE TO PREVENT PIPING AND UNDERCUTTING.
3. SECURELY ANCHOR BALES IN PLACE BY EITHER TWO STAKES OR RE-BARS DRIVEN THROUGH THE BALE 12 TO 18 INCHES INTO THE GROUND. DRIVE THE FIRST STAKE IN EACH BALE TOWARD THE PREVIOUSLY LAID BALE AT AN ANGLE TO FORCE THE BALES TOGETHER. DRIVE THE STAKES FLUSH WITH THE TOP OF THE BALE.
4. IMMEDIATELY INSPECT STRAW BALE BARRIERS AFTER EACH RAINFALL AND AT LEAST DAILY DURING PROLONGED RAINFALL EVENTS. RE-DRIVE THE ANCHORING STAKES IF THEY BECOME EXPOSED. REMOVE SEDIMENT WHEN THE LEVEL OF DEPOSITION REACHES APPROXIMATELY ONE HALF THE HEIGHT OF THE BARRIER.
5. REMOVE ALL BALES WHEN THE SITE HAS BEEN STABILIZED. GRADE FLUSH AND STABILIZE THE TRENCH WHERE THE BALES WERE LOCATED.

DATE	APPR	
REVISED		
ISSUED:		
	REFERENCE	

**STRAW BALE DIKE**

★ ★ ★ DISTRICT OF COLUMBIA  
DEPARTMENT OF ENERGY & ENVIRONMENT

DWG. NO 305.1

(SOURCE: 2011 MARYLAND STANDARDS & SPECIFICATIONS)

Detail 14 – 305.1 Straw Bale Dike

## **3.6 Culvert Inlet Protection**

### **3.6.1 Definition**

A barrier installed across a culvert entrance to temporarily pond sediment-laden water, thereby reducing the sediment content.

### **3.6.2 Purpose**

To prevent sediment from entering, accumulating in, and being transferred by a culvert and associated drainage system prior to permanent stabilization of a disturbed project area.

To provide erosion control at culvert inlets during the phase of a project where elevation and drainage patterns change, causing original control measures to be ineffective or in need of removal.

### **3.6.3 Conditions Where Practice Applies**

Where culvert and associated drainage system is to be made operational prior to permanent stabilization of the disturbed drainage area. Different types of structures are applicable to different conditions (see Details 306.1 and 306.2).

### **3.6.4 Design Criteria**

#### Planning Considerations

When construction on a project reaches a stage where culverts and other storm sewer appurtenances are installed and many areas are brought to a desired grade, the erosion control measures used in the early stages normally need to be modified or may need to be removed altogether. At that time, there is a need to provide protection at the points where runoff will leave the area via culverts and drop or curb inlets.

Similar to drop and curb inlets, culverts which are made operational prior to stabilization of the associated drainage areas can convey large amounts of sediment to natural drainageways. In case of extreme sediment loading, the pipe or pipe system itself may clog and lose a major portion of its capacity. To avoid these problems, it is necessary to prevent sediment from entering the culvert by using one of the methods noted in this section.

#### General Guidelines (All Types)

1. Construct the inlet protection device in a manner that will facilitate cleanout and disposal of trapped sediment and minimize interference with flow paths and construction activities.
2. Construct the inlet protection devices in such a manner that any resultant ponding of stormwater will not cause damage or nuisance to adjacent areas or structures.
3. Design criteria more specific to each particular inlet protection device are found in Details 306.1 and 306.2.

#### Silt Fence/Filter Sock Culvert Inlet Protection

1. No formal design is required.
2. Silt fence culvert inlet protection has an expected maximum usable life of 3 months. Filter sock option has a maximum usable life of 6 months.
3. The maximum area draining to this practice must not exceed 1 acre.
4. Section 3.3 Filter Socks may be used instead of silt fence.

#### Culvert Inlet Sediment Trap

1. Runoff storage requirements must be in accordance with information outlined under Section 6.1 Sediment Traps.
2. Contains trenched "wet" retention storage area.
3. Culvert inlet sediment traps have a maximum expected useful life of 18 months unless otherwise directed by inspection.
4. The maximum area draining to this practice must not exceed 3 acres.
5. 67 cubic yards of dry storage and 67 cubic yards of wet storage must be provided for each acre of drainage area. See Details 306.2 and 306.3.

### **3.6.5 Construction Specifications**

#### Silt Fence Culvert Inlet Protection

1. The height of the silt fence (in front of the culvert opening) must be a minimum of 16 inches and must not exceed 34 inches.
2. Class PE, Type I, woven geotextile with a maximum spacing of stakes of 3 feet must be used to construct the measure. This is not the same geotextile fabric which is normally used in Silt Fence.
3. Place the silt fence approximately 6 feet from the culvert in the direction of incoming flow, creating a "horseshoe" shape as shown in Detail 306.1.
4. If silt fence cannot be installed properly or the flow and/or velocity of flow to the culvert protection is excessive and may breach the structure, utilize the Filter Sock option, or Stone Combination noted in Detail 306.1.

#### Filter Sock Option

1. See Section 3.3 Filter Sock.
2. Filter Socks may be used in place of silt fence for culvert inlet protection.
3. At minimum, place one 18-inch filter sock or two layers of 12-inch filter sock. At maximum, one base layer of 24-inch filter socks and a topping layer of 18-inch filter sock may be applied.
4. In addition to normal stake spacing requirements, filter socks must be staked at the toe of the fill slope.

### Culvert Inlet Sediment Trap

1. Geometry of the design will be a "horseshoe" shape around the culvert inlet (see Detail 306.2).
2. The toe of riprap (composing the sediment filter dam) must be no closer than 24 inches from the culvert opening in order to provide an acceptable emergency outlet for flows from larger storm events.
3. The toe of the upstream aggregate face of the sediment filter dam must be no closer than 12 inches from the edge of the sediment storage area in order to provide stability to the dam.
4. All other Construction Specifications found within Section 6.1 Sediment Traps also apply to this practice.

### **3.6.6 Maintenance**

1. Inspect the structure after each rain and make repairs as needed.
2. Replace or clean the aggregate when inspection reveals that clogged voids are causing ponding problems which interfere with on-site construction.
3. Remove the sediment and restore the impoundment to its original dimensions when sediment has accumulated to half the volume of the wet storage zone. Deposit removed sediment in a suitable area and in such a manner that it will not erode and cause sedimentation problems.
4. Remove temporary structures when they have served their useful purpose and stabilize the area, but not before the upslope area has been permanently stabilized.





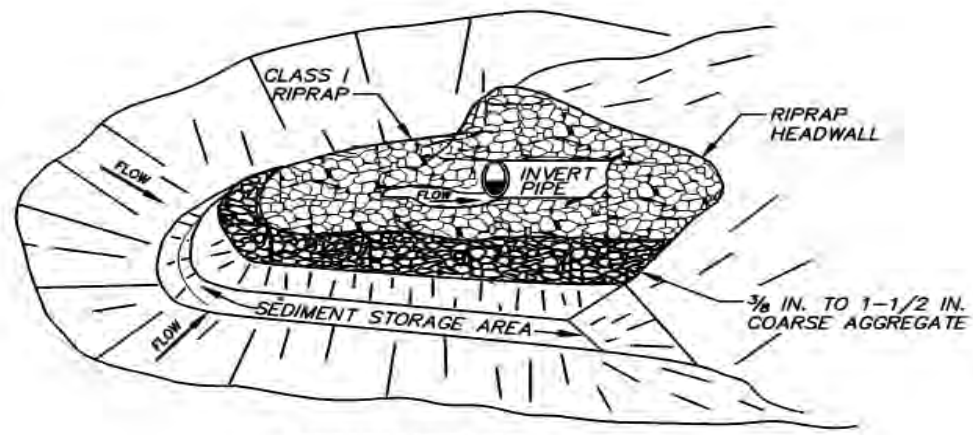
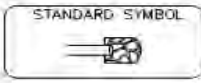

**PERSPECTIVE VIEW**

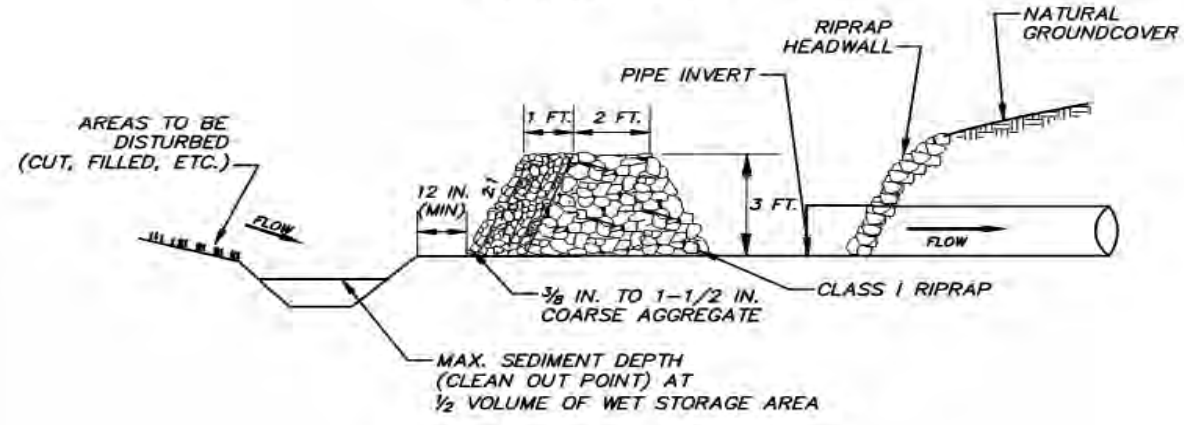

**ELEVATION VIEW**

- NOTE:**
- THE MAXIMUM AREA DRAINING TO THIS PRACTICE SHALL NOT EXCEED 3 ACRES.
  - 67 C.Y./ACRE WET STORAGE (BELOW BASE OF STONE)
  - 67 C.Y./ACRE DRY STORAGE (BASE OF STONE TO TOP OF STONE BERM)

DATE	APPR	
REVISED		
ISSUED:		
	REFERENCE	

**CULVERT INLET PROTECTION-2**

★ ★ ★ DISTRICT OF COLUMBIA  
DEPARTMENT OF ENERGY &  
ENVIRONMENT

DWG. NO 306.2

© SOURCE: 2011 MARYLAND STANDARDS & SPECIFICATIONS

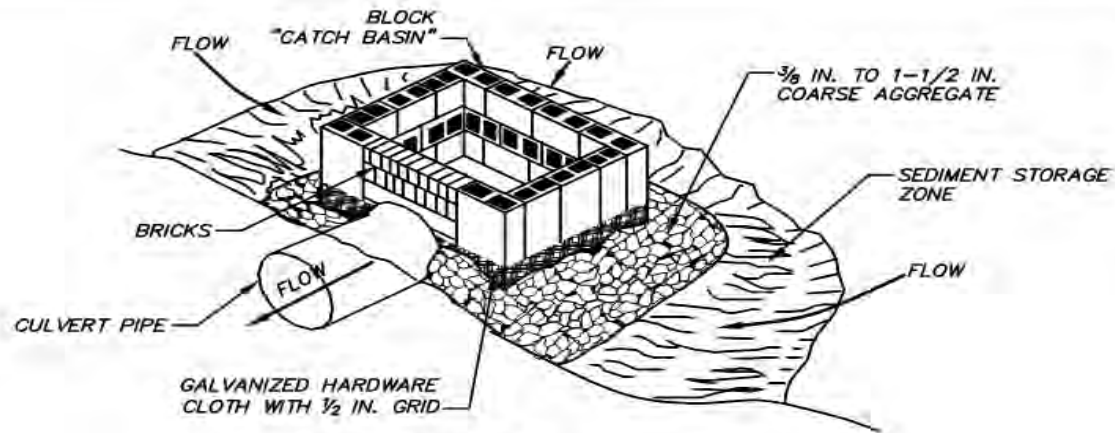

**PERSPECTIVE VIEW**

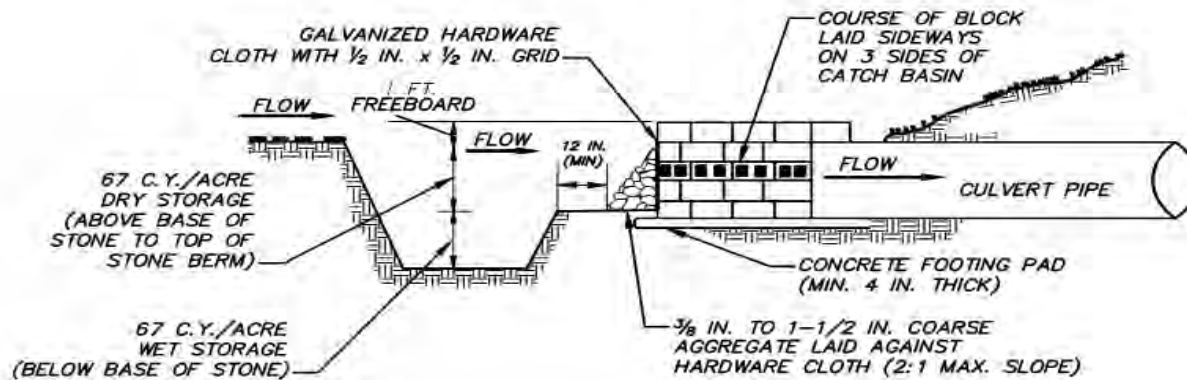
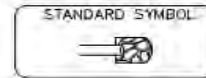

**CROSS SECTION THROUGH "CATCH BASIN"**

**NOTE:**  
 • ALL BLOCKS AND BRICKS MORTARED SIMILAR TO BUILDING FOUNDATION.

DATE	APPR	
REVISED		
ISSUED:		
	REFERENCE	

**CULVERT INLET PROTECTION-3**

★ ★ ★ DISTRICT OF COLUMBIA  
 DEPARTMENT OF ENERGY &  
 ENVIRONMENT

DWG. NO 306.3

(SOURCE: 2011 MARYLAND STANDARDS & SPECIFICATIONS)

## **3.7 Storm Drain Inlet Protection**

### **3.7.1 Definition**

A filter constructed around a storm drain inlet.

### **3.7.2 Purpose**

Storm drain inlet protection is used to filter sediment-laden runoff before it enters the storm drain system.

### **3.7.3 Conditions Where Practices Applies**

Storm drain inlet protection is a secondary sediment control device and is not to be used in place of a sediment trapping device unless approved by the appropriate approval authority.

### **3.7.4 Design Criteria**

Use storm drain inlet protection when the drainage area to an inlet is disturbed and the following conditions prevail:

1. It is not possible to temporarily divert the storm drain outfall into a sediment trapping device;
2. Watertight blocking of inlets is not advisable; and
3. Drainage area is  $\frac{1}{4}$  acre (maximum) for curb, standard inlet protection, and standard inlet guard. Drainage area is 1 acre (maximum) for median, at grade, or block and gravel drop inlet protection.

Where site conditions necessitate use of inlet protection for sediment trapping of 3,600 cubic feet per acre, excavation may be created around the block and gravel drop inlet protection for such storage (see Construction Specifications).

### **3.7.5 Construction Specifications**

#### **Standard Inlet Protection (SIP) (Elevated or Yard Inlet)**

1. Excavate completely around the inlet to a depth of 18 inches below the notch elevation.
2. Drive 2-inch  $\times$  4-inch construction grade lumber posts 1 foot into the ground at each corner of the inlet. Place nail strips between the posts on the ends of the inlet. Assemble the top portion of the 2-inch  $\times$  4-inch frame using the overlap joint shown on Detail 307.1. The top of the frame (weir) must be 6 inches below adjacent roadways where flooding and safety issues may arise.
3. Stretch  $\frac{1}{2}$ -inch  $\times$   $\frac{1}{2}$ -inch wire mesh tightly around the frame and fasten securely. The ends must meet and overlap at a post.
4. Stretch the Geotextile Class E (refer to Appendix A, Table A.2) tightly over the wire mesh with the geotextile extending from the top of the frame to 18 inches below the inlet notch

elevation. Fasten the geotextile firmly to the frame. The ends of the geotextile must meet at a post, be overlapped and folded, then fastened down.

5. Backfill around the inlet in compacted 6-inch layers until the layer of earth is level with the notch elevation on the ends and top elevation on the sides.
6. If the inlet is not in a sump, construct a compacted earth dike across the ditch line directly below it. The top of the earth dike should be at least 6 inches higher than the top of the frame.
7. The structure must be inspected periodically and after each rain and the geotextile replaced when it becomes clogged.

#### At Grade Inlet Protection (AGIP)

1. Lift grate and wrap with Geotextile Class E to completely cover all openings, secure with wire ties, then set grate back in place.
2. Place  $\frac{3}{4}$ -inch to  $1\frac{1}{2}$ -inch stone or equivalent recycled concrete (refer to Appendix A, Table A.2), 4 to 6 inches thick on the grate to secure the fabric.
3. If there are any signs of street flooding or water ponding, this structure must be cleaned or replaced, or redesigned with a viable alternative.

#### Curb Inlet Protection (CIP)

1. Attach a continuous piece of  $\frac{1}{2}$ -inch  $\times$   $\frac{1}{2}$ -inch wire mesh (30 inches minimum width by throat length, plus 4 feet) to the 2-inch  $\times$  4-inch weir (measuring throat length plus 2 feet) as shown on the standard drawing.
2. Place a continuous piece of approved Geotextile Class E of the same dimensions as the wire mesh over the wire mesh and securely attach it to the 2-inch  $\times$  4-inch weir.
3. Securely nail the 2-inch by 4-inch weir to a 9-inch long vertical spacer to be located between the weir and the inlet face (maximum 4 feet apart).
4. Place the assembly against the inlet throat and nail (minimum 2-foot lengths of 2 inches by 4 inches to the top of the weir at spacer locations). Extend these 2-inch by 4-inch anchors across the inlet top and be held in place by sandbags or alternate weight.
5. Place the assembly so that the end spacers are 1 foot beyond both ends of the throat opening.
6. Form the  $\frac{1}{2}$ -inch by  $\frac{1}{2}$ -inch wire mesh and the geotextile fabric to the concrete gutter and against the face of the curb on both sides of the inlet. Place clean  $\frac{3}{4}$ -inch to  $1\frac{1}{2}$ -inch stone over the wire mesh and geotextile in such a manner as to prevent water from entering the inlet under or around the geotextile.
7. This type of protection must be inspected frequently and the geotextile fabric and stone replaced when clogged with sediment.
8. Assure that storm flows do not bypass the inlet by installing a temporary earth or asphalt dike to direct the flow to the inlet.
9. If there are any signs of street flooding or water ponding, this structure must be cleaned or replaced, or redesigned with a viable alternative such as Section 3.3 Filter Sock.

Note: Section 3.3 Filter Sock is an alternative which is easier to install and maintain than this standard design.

#### Median Inlet Protection (MIP)

1. Construct standard silt fence appropriate for the slopes leading to the inlet and having 5-foot post spacing 1.5 feet away from the existing inlet only on the sides of the inlet receiving sheet flow and in the location of the "wings".
2. In the location of concentrated flow, construct a stone check dam using 4 to 7-inch stone for the base faced on the upstream side with  $\frac{3}{4}$ -inch to  $1\frac{1}{2}$ -inch aggregate, 1 foot thick. The stone check dam must be 16 inches high with the weir 10 inches above the invert of the ditch or valley gutter and must be the same width as the ditch or gutter bottom or 2 feet (minimum). Where the end of the "wings" meet the ground must be at or above the weir elevation.
3. If there are any signs of street flooding or water ponding, this structure must be cleaned or replaced or redesigned with a viable alternative.

#### Standard Inlet Guard (SIG)

1. Position guard sections to cover inlet with at least 2 inches of overlap on each end of inlet.
2. Overlap guards at least 2 inches at their intersections.
3. Position the desired filter cloth around guard so that it can be tucked in at the bottom.
4. Position the cloth so that the horizontal metal strip can hold the cloth in place.
5. Do not cover the 2-inch overflow holes with cloth.
6. Attach horizontal strip with sheet metal screws.
7. Place end clips into position so that the triangular end gap is covered and bend covers the face.
8. Place 2-inch attaching clips at the ends and intersections of the guards.
9. Insert the attaching bolt, nail, or screw as shown in Detail 307.5.
10. Make a watertight connection along the sides and bottom of the inlet guard with the street and curb.
11. If there are any signs of street flooding or water ponding, this structure must be cleaned or replaced or redesigned with a viable alternative.

#### Block and Gravel Drop Inlet Protection

1. Excavate completely around the inlet to a depth of 2 inches below the crest of the storm drain.
2. The bottom row of blocks is placed against the edge of the storm drain for lateral support and to avoid washouts when overflow occurs. One block is placed on each side of the structure on its side in the bottom row to allow pool drainage. If needed, lateral support may be given to subsequent rows by placing 2-inch by 4-inch wood studs through block openings.

3. Hardware cloth or comparable wire mesh with ½-inch openings must be fitted over all block openings to hold gravel in place.
4. Place clean #57 gravel 2 inches below the top of the block on a 2:1 slope or flatter and smooth to an even grade.
5. For sediment storage, provide a minimum excavated depth of 1.5 feet. Side slopes should not be steeper than 2:1. Include the following information when using this inlet protection in conjunction with sediment storage.

**Block and Gravel Drop Inlet Protection – Sediment Storage Information**

1. **Drainage area** = \_\_\_\_\_ acre
2. Required sediment storage = 3,600 cubic feet/acre × \_\_\_\_\_ acres (drainage area)  
**Required sediment storage** = \_\_\_\_\_ cubic feet
3. Assume excavation **depth** (minimum of 1.5 ft.) = \_\_\_\_\_ feet
4. Assume **slope of sides** (must not be steeper than 2:1) = \_\_\_\_ :1
5. Determine required surface area  
 $SA_{min} = \text{Required sediment storage (\#2 above)} \div \text{excavation depth (\#3 above)}$   
 $SA_{min} = \text{_____ cubic feet} \div \text{_____ feet}$   
 $SA_{min} = \text{_____ square feet}$
6. Assume shape of excavation and determine dimensions.  
 (A rectangular shape with 2:1 length to width ratio is recommended.)  
**Shape:** \_\_\_\_\_  
**Dimensions:** l = \_\_\_\_\_ feet; w = \_\_\_\_\_ feet; diameter (*if applicable*) = \_\_\_\_\_ feet

**3.7.6 Maintenance**

Maintenance requirements for storm drain inlet protection may be intense, due to the susceptibility to clogging. When the structure does not drain completely within 48 hours after a storm event, it is clogged. When this occurs, accumulated sediment must be removed and the geotextile fabric and stone must be cleaned or replaced.



MAXIMUM DRAINAGE AREA = 1/4 ACRE

STANDARD SYMBOL  
SIP

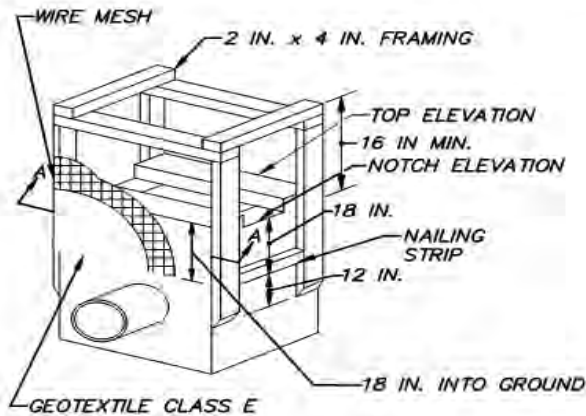

ISOMETRIC

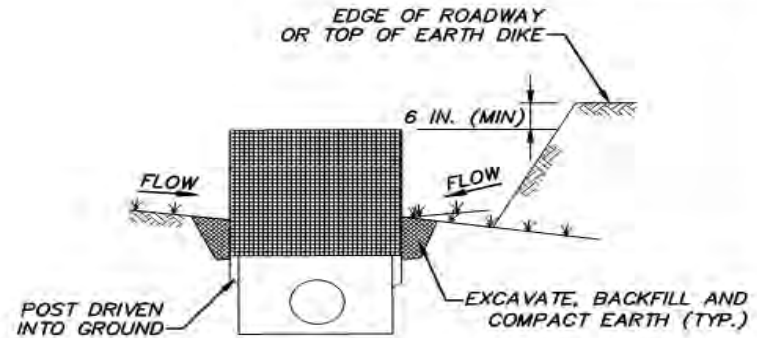

SECTION A-A

**CONSTRUCTION SPECIFICATIONS**

1. EXCAVATE COMPLETELY AROUND THE INLET TO A DEPTH OF 18 INCHES BELOW THE NOTCH ELEVATION.
2. DRIVE 2-INCH x 4-INCH CONSTRUCTION GRADE LUMBER POSTS 1 FOOT INTO THE GROUND AT EACH CORNER OF THE INLET. PLACE NAIL STRIPS BETWEEN THE POSTS ON THE ENDS OF THE INLET. ASSEMBLE THE TOP PORTION OF THE 2-INCH x 4-INCH FRAME USING THE OVERLAP JOINT SHOWN ON DETAIL 307.1. THE TOP OF THE FRAME (WEIR) MUST BE 6 INCHES BELOW ADJACENT ROADWAYS WHERE FLOODING AND SAFETY ISSUES MAY ARISE.
3. STRETCH 1/2-INCH x 1/2-INCH WIRE MESH TIGHTLY AROUND THE FRAME AND FASTEN SECURELY. THE ENDS MUST MEET AND OVERLAP AT A POST.
4. STRETCH THE GEOTEXTILE CLASS E TIGHTLY OVER THE WIRE MESH WITH THE GEOTEXTILE EXTENDING FROM THE TOP OF THE FRAME TO 18 INCHES BELOW THE INLET NOTCH ELEVATION. FASTEN THE GEOTEXTILE FIRMLY TO THE FRAME. THE ENDS OF THE GEOTEXTILE MUST MEET AT A POST, BE OVERLAPPED AND FOLDED, THEN FASTENED DOWN.
5. BACKFILL AROUND THE INLET IN COMPACTED 6-INCH LAYERS UNTIL THE LAYER OF EARTH IS LEVEL WITH THE NOTCH ELEVATION ON THE ENDS AND TOP ELEVATION ON THE SIDES.
6. IF THE INLET IS NOT IN A SUMP, CONSTRUCT A COMPACTED EARTH DIKE ACROSS THE DITCH LINE DIRECTLY BELOW IT. THE TOP OF THE EARTH DIKE SHOULD BE AT LEAST 6 INCHES HIGHER THAN THE TOP OF THE FRAME.
7. THE STRUCTURE MUST BE INSPECTED PERIODICALLY AND AFTER EACH RAIN AND THE GEOTEXTILE REPLACED WHEN IT BECOMES CLOGGED.

DATE	APPR	
REVISED		
ISSUED:		
		REFERENCE

**STANDARD INLET PROTECTION  
STORM DRAIN INLET PROTECTION**

★ ★ ★ DISTRICT OF COLUMBIA  
DEPARTMENT OF ENERGY &  
ENVIRONMENT

DWG. NO 307.1

SOURCE: 2011 MARYLAND STANDARDS AND SPECIFICATIONS

MAXIMUM DRAINAGE AREA = ¼ ACRE

STANDARD SYMBOL  
AGIP

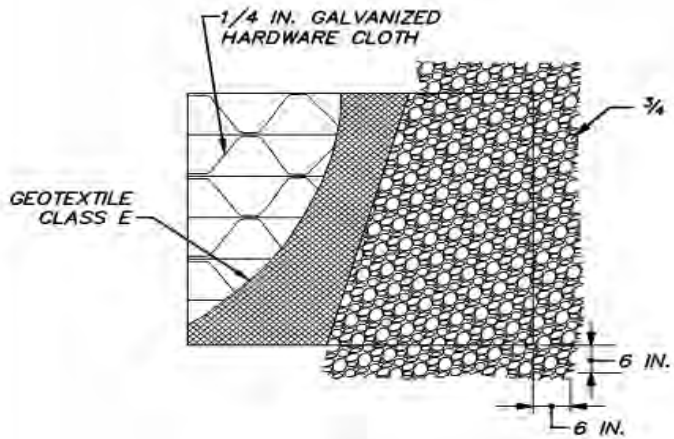

PLAN/CUT AWAY VIEW

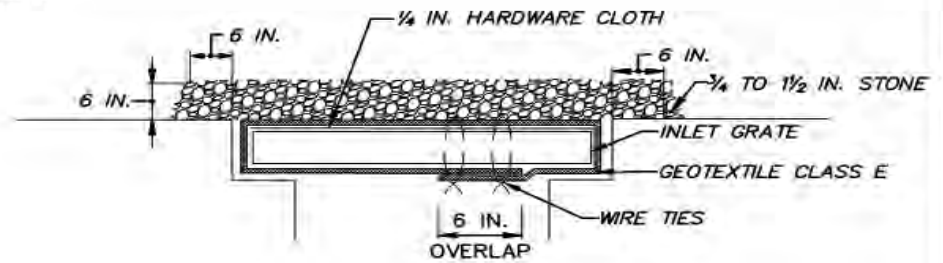

CROSS SECTION

**CONSTRUCTION SPECIFICATIONS**

1. LIFT GRATE AND WRAP WITH GEOTEXTILE CLASS E TO COMPLETELY COVER ALL OPENINGS, SECURE WITH WIRE TIES, THEN SET GRATE BACK IN PLACE.
2. PLACE CLEAN ¾ TO 1-½ INCH STONE OR EQUIVALENT RECYCLED CONCRETE, 4 TO 6 INCHES THICK ON THE GRATE TO SECURE THE FABRIC.
3. IF THERE ARE ANY SIGNS OF STREET FLOODING OR WATER PONDING, THIS STRUCTURE MUST BE CLEANED OR REPLACED, OR REDESIGNED WITH A VIABLE ALTERNATIVE.

DATE	APPR	
REVISED		
ISSUED:		
	REFERENCE	

**AT GRADE INLET PROTECTION  
STORM DRAIN INLET PROTECTION**

\*\*\* DISTRICT OF COLUMBIA  
DEPARTMENT OF ENERGY &  
ENVIRONMENT

DWG. NO 307.2

SOURCE: 2011 MARYLAND STANDARDS AND SPECIFICATIONS



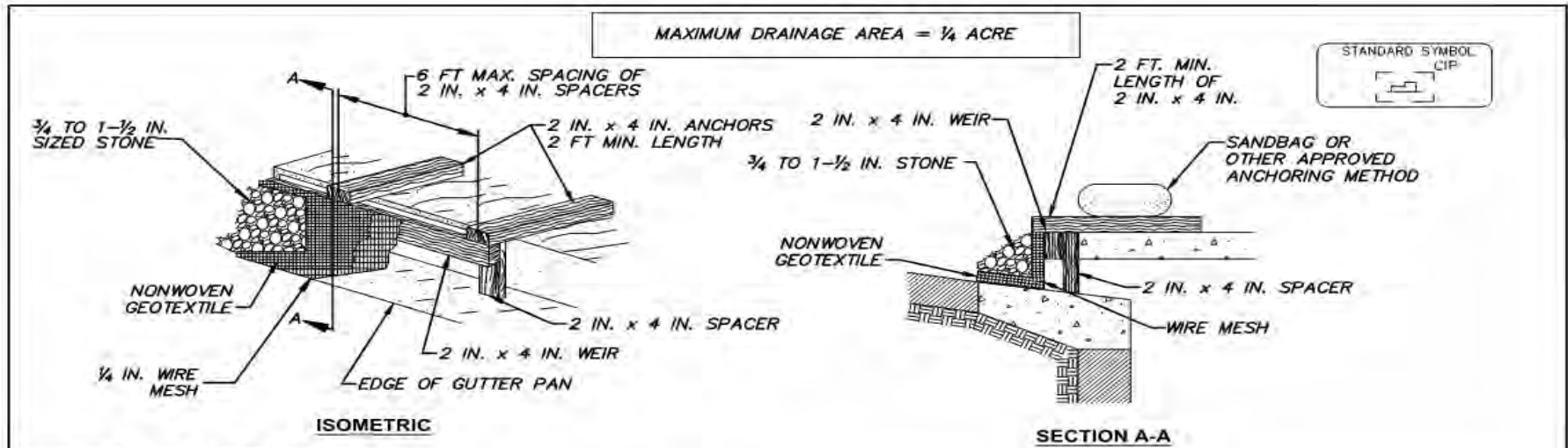

**CONSTRUCTION SPECIFICATIONS**

1. ATTACH A CONTINUOUS PIECE OF 1/2 INCH x 1/2 INCH WIRE MESH, (30 INCHES MINIMUM WIDTH BY THROAT LENGTH, PLUS 4 FEET) TO THE 2-INCH x 4-INCH WEIR (MEASURING THROAT LENGTH PLUS 2 FEET) AS SHOWN ON THE STANDARD DRAWING.
2. PLACE A CONTINUOUS PIECE OF GEOTEXTILE CLASS E OF THE SAME DIMENSIONS AS THE WIRE MESH OVER THE WIRE MESH AND SECURELY ATTACH TO THE 2-INCH x 4-INCH WEIR.
3. SECURELY NAIL THE 2-INCH x 4-INCH WEIR TO A 9-INCH LONG VERTICAL SPACER TO BE LOCATED BETWEEN THE WEIR AND THE INLET FACE (MAXIMUM 4 FEET APART).
4. PLACE THE ASSEMBLY AGAINST THE INLET THROAT AND NAIL (MINIMUM 2-FOOT LENGTHS OF 2-INCHES x 4-INCHES TO THE TOP OF THE WEIR AT SPACER LOCATIONS). EXTEND THESE 2-INCH x 4-INCH ANCHORS ACROSS THE INLET TOP AND BE HELD IN PLACE BY SANDBAGS OR ALTERNATE WEIGHT.
5. PLACE THE ASSEMBLY SO THAT THE END SPACERS ARE 1 FOOT BEYOND BOTH ENDS OF THE THROAT OPENING.
6. FORM THE 1/2-INCH x 1/2-INCH WIRE MESH AND THE GEOTEXTILE FABRIC TO THE CONCRETE GUTTER AND AGAINST THE FACE OF THE CURB ON BOTH SIDES OF THE INLET. PLACE CLEAN 3/4 TO 1-1/2 INCH STONE OVER THE WIRE MESH AND GEOTEXTILE IN SUCH A MANNER AS TO PREVENT WATER FROM ENTERING THE INLET UNDER OR AROUND THE GEOTEXTILE.
7. THIS TYPE OF PROTECTION MUST BE INSPECTED FREQUENTLY AND THE GEOTEXTILE FABRIC AND STONE REPLACED WHEN CLOGGED WITH SEDIMENT.
8. ASSURE THAT STORM FLOWS DO NOT BYPASS THE INLET BY INSTALLING A TEMPORARY EARTH OR ASPHALT DIKE TO DIRECT THE FLOW TO THE INLET.
9. IF THERE ARE ANY SIGNS OF STREET FLOODING OR WATER PONDING, THIS STRUCTURE MUST BE CLEANED OR REPLACED, OR REDESIGNED WITH A VIABLE ALTERNATIVE SUCH AS 3.3 FILTER SOCK.

\*NOTE: FILTER SOCK IS AN ALTERNATIVE WHICH IS EASIER TO INSTALL AND MAINTAIN THAN THIS STANDARD DESIGN.

DATE	APPR	
REVISED		
ISSUED:		
	REFERENCE	

**CURB INLET PROTECTION  
STORM DRAIN INLET PROTECTION**

 DISTRICT OF COLUMBIA  
 DEPARTMENT OF ENERGY &  
 ENVIRONMENT

DWG. NO 307.3

SOURCE: 2011 MARYLAND STANDARDS AND SPECIFICATIONS

Detail 20 – 307.3 Curb Inlet Protection

MAXIMUM DRAINAGE AREA = 1 ACRE

STANDARD SYMBOL

MIP

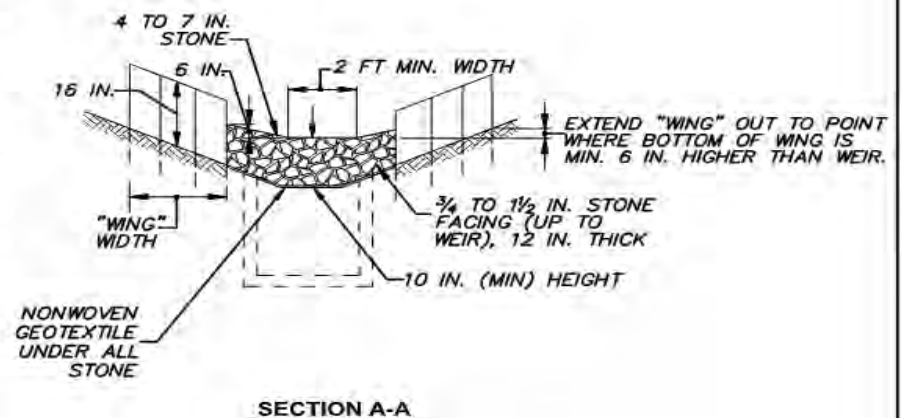
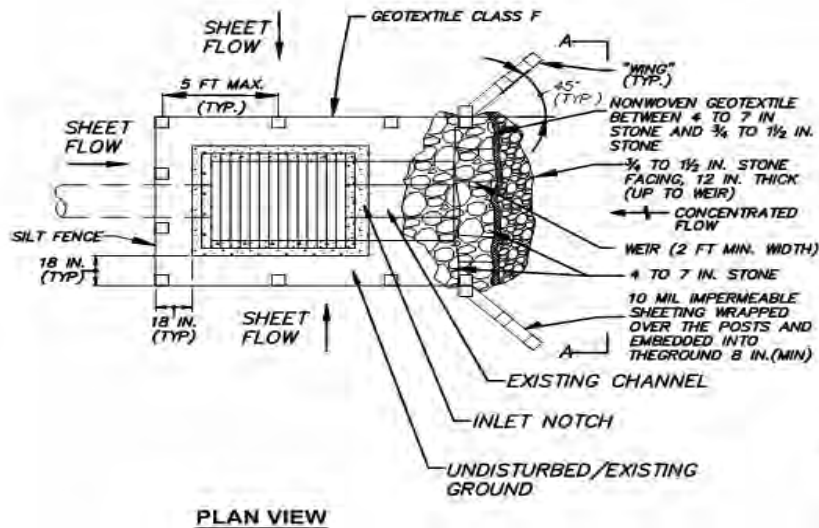

**CONSTRUCTION SPECIFICATIONS**

1. CONSTRUCT STANDARD SILT FENCE APPROPRIATE FOR THE SLOPES LEADING TO THE INLET AND HAVING 5-FOOT POST SPACING 1-1/2 FEET AWAY FROM THE EXISTING INLET ONLY ON THE SIDES OF THE INLET RECEIVING SHEET FLOW AND IN THE LOCATION OF THE "WINGS".
2. IN THE LOCATION OF CONCENTRATED FLOW, CONSTRUCT A STONE CHECK DAM USING 4 TO 7-INCH STONE FOR THE BASE FACED ON THE UPSTREAM SIDE WITH 3/4-INCH TO 1-1/2 INCH AGGREGATE, 1 FOOT THICK. THE STONE CHECK DAM MUST BE 16 INCHES HIGH WITH THE WEIR 10 INCHES ABOVE THE INVERT OF THE DITCH OR VALLEY GUTTER AND MUST BE THE SAME WIDTH AS THE DITCH OR GUTTER BOTTOM OR 2 FEET (MINIMUM). WHERE THE END OF THE "WINGS" MEET THE GROUND MUST BE AT OR ABOVE THE WEIR ELEVATION.
3. IF THERE ARE ANY SIGNS OF STREET FLOODING OR WATER PONDING, THIS STRUCTURE MUST BE CLEANED OR REPLACED OR REDESIGNED WITH A VIABLE SOLUTION.

DATE	APPR	
REVISED		
ISSUED:		
	REFERENCE	

**MEDIAN INLET PROTECTION  
STORM DRAIN INLET PROTECTION**

★ ★ ★ DISTRICT OF COLUMBIA  
DEPARTMENT OF ENERGY & ENVIRONMENT

DWG. NO 307.4

SOURCE: 2011 MARYLAND STANDARDS AND SPECIFICATIONS

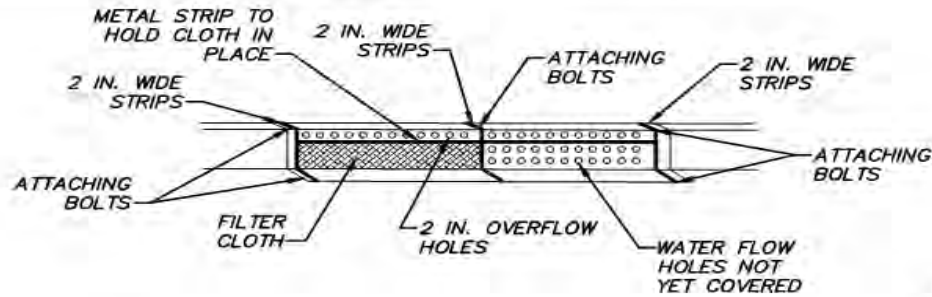

**NOTE:**  
 • AT EACH INTERSECTION OF INLET PROTECTION OVERLAP A MINIMUM OF 2 IN.

**STANDARD INLET GUARD ATTACHMENT METHOD**

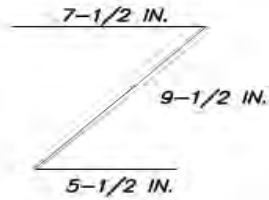

**NOTE:**  
 • THE TOP MEASUREMENT OF 7-1/2 IN. IS SET TO PROVIDE A 2 IN. EXTENSION FOR OVERFLOW WHILE AVOIDING BLOCKAGE OF THE MANHOLE COVER.  
 • MAKE A WATERTIGHT CONNECTION ALONG THE SIDES AND BOTTOM OF THE INLET GUARD WITH THE STREET AND CURB.

**STANDARD INLET GUARD DIMENSIONS**

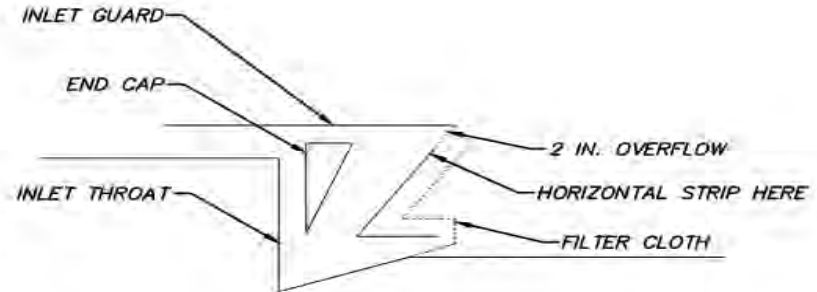

**STANDARD INLET GUARD CROSS SECTION**

DATE	APPR	
REVISED		
ISSUED:		
	REFERENCE	

**STANDARD INLET GUARD  
 STORM DRAIN INLET PROTECTION**



DISTRICT OF COLUMBIA  
 DEPARTMENT OF ENERGY &  
 ENVIRONMENT

DWG. NO 307.5

SOURCE: 2011 MARYLAND STANDARDS AND SPECIFICATIONS



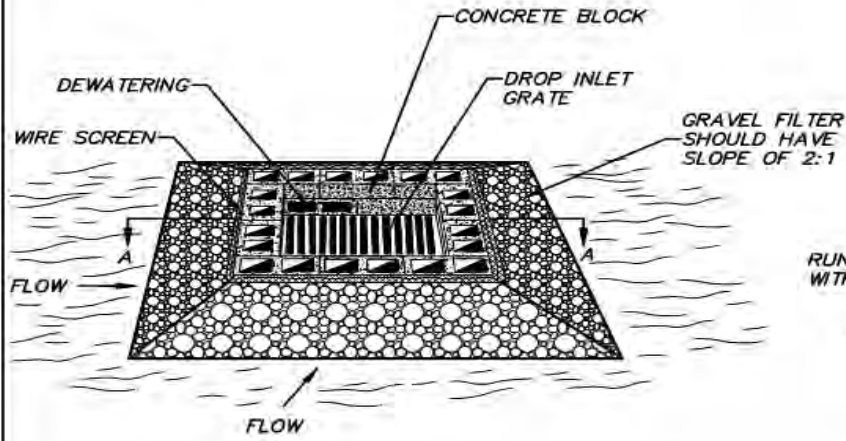

**BLOCK AND GRAVEL ISOMETRIC VIEW**

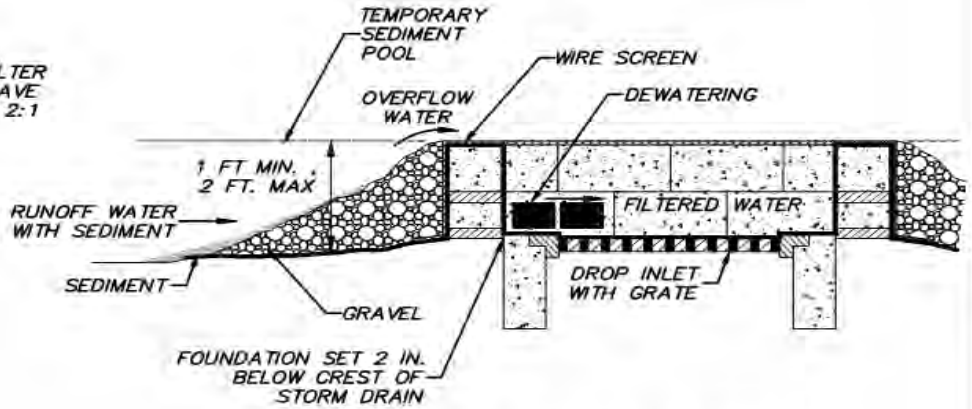

**BLOCK AND GRAVEL SECTION A-A**

**CONSTRUCTION SPECIFICATIONS**

1. EXCAVATE COMPLETELY AROUND THE INLET TO A DEPTH OF 2 INCHES BELOW THE CREST OF THE STORM DRAIN.
2. THE BOTTOM ROW OF BLOCKS IS PLACED AGAINST THE EDGE OF THE STORM DRAIN FOR LATERAL SUPPORT AND TO AVOID WASHOUTS WHEN OVERFLOW OCCURS. ONE BLOCK IS PLACED ON EACH SIDE OF THE STRUCTURE ON ITS SIDE IN THE BOTTOM ROW TO ALLOW POOL DRAINAGE. IF NEEDED, LATERAL SUPPORT MAY BE GIVEN TO SUBSEQUENT ROWS BY PLACING 2 INCH x 4 INCH WOOD STUDS THROUGH BLOCK OPENINGS.
3. HARDWARE CLOTH OR COMPARABLE WIRE MESH WITH 1/2 INCH OPENINGS MUST BE FITTED OVER ALL BLOCK OPENINGS TO HOLD GRAVEL IN PLACE.
4. PLACE CLEAN #57 GRAVEL 2 INCHES BELOW THE TOP OF THE BLOCK ON A 2:1 SLOPE OR FLATTER AND SMOOTH TO AN EVEN GRADE.
5. FOR SEDIMENT STORAGE, PROVIDE A MINIMUM EXCAVATED DEPTH OF 1.5 FEET. SIDE SLOPES SHOULD NOT BE STEEPER THAN 2:1.

DATE	APPR
REVISED	
ISSUED:	
	REFERENCE

**BLOCK AND GRAVEL DROP INLET PROTECTION  
STORM DRAIN INLET PROTECTION**

 DISTRICT OF COLUMBIA  
 DEPARTMENT OF ENERGY &  
 ENVIRONMENT  

---

 DWG. NO 307.6

SOURCE: MANUAL FOR EROSION AND SEDIMENT CONTROL IN GEORGIA

## **3.8 Stone Check Dams**

### **3.8.1 Definition**

Stone check dams are small rock dams with weirs placed in series in swales or ditches.

### **3.8.2 Purpose**

To reduce runoff velocities to non-erosive rates and to prevent channel erosion in drainage courses.

### **3.8.3 Conditions Where Practice Applies**

This practice is limited for use in small open channels where it is necessary to slow the velocity of flows in order to prevent erosion. Check dams may be installed as temporary structures during the construction phase or may remain as permanent stormwater management structures. They should not be used in a free-flowing stream.

Some specific applications include the following:

1. Temporary swales or channels which, because of their short length of service, cannot receive a non-erodible lining but still need some protection to reduce erosion.
2. Permanent swales or channels which for some reason cannot receive a permanent non-erodible lining for an extended period of time.
3. Either temporary or permanent swales or channels which need protection during the establishment of grass linings.

### **3.8.4 Design Criteria**

1. Locate stone check dams so as to provide maximum velocity reduction. This may be achieved by considering the volume of runoff, the drainage area and the slope. Place the check dams in reasonably straight ditch sections to minimize the potential for erosion in the channel bend.
2. Key all stone check dams into the sides and bottom of the channel. This practice is not to be used as a sediment trapping device. Sediment-laden runoff must pass through a sediment trapping device prior to being discharged from the site.
3. The distance between the stone check dams will vary with the longitudinal ditch slope. Construct stone check dams using 4 to 7-inch stone or recycled concrete equivalent and place to form a weir. The outlet crest or the top of the stone weir must be approximately 6 inches lower than the outer edges.
4. Line the inside or upstream side of the weir with a 1 foot thick layer of washed ¾-inch to 1½-inch crushed aggregate. Place geotextile Class E (refer to Appendix A, Table A.1) or better (SD Type I, non-woven, or PE Type I, non-woven) lining beneath the bottom and sides of the dam prior to placement of stone.

5. The height of the stone outlet weir should not exceed one-half the depth of the ditch or swale. Additionally, the maximum height of the weir must not exceed 2 feet to prevent scour of the toe of the dam. If the check dam exceeds this, these provisions do not apply and an engineering analysis must be conducted. The stone check dam must be wide enough to reach from bank to bank of the ditch or swale with the weir section length in the center of the dam.
6. The number of check dams will depend on the length and slope of the ditch or swale.
7. The required spacing is determined as:

$$x = \frac{y}{S}$$

Where:

- x = Check dam longitudinal spacing (ft)
- y = Check dam height (ft)
- S = Natural channel slope (ft/ft); elevation change per longitudinal run

Figure 3.3 may be used to determine the check dam spacing. The spacing requirements do not change significantly with varying ditch cross sections, but are most sensitive to the channel slope and height of the check dam.

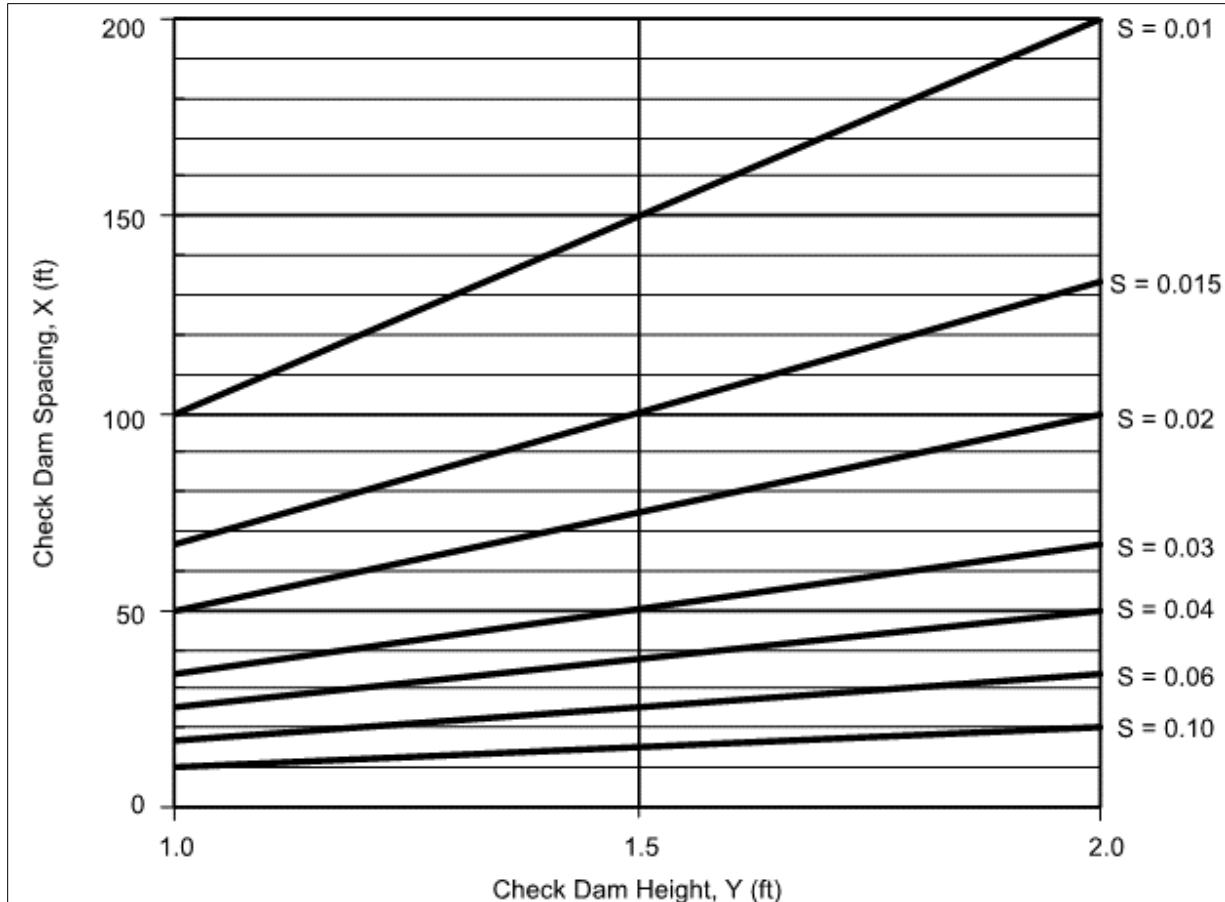

Figure 3.3 Check dam spacing lookup, based on height and longitudinal slope.

### 3.8.5 Construction Specifications

1. Prepare swales and ditches in accordance with the construction specifications described in Section 4.4 Temporary Swales.
2. Construct the check dam of 4 to 7-inch stone. Place the stone so that it completely covers the width of the channel and is keyed into the channel banks.
3. Construct the top of the check dam so that the center is approximately 6 inches lower than the outer edges, forming a weir that water can flow across.
4. The maximum height of the check dam at the center must not exceed 2 feet or half the height of the channel.
5. Line the upstream side of the check dam with approximately 1 foot of  $\frac{3}{4}$  to  $1\frac{1}{2}$ -inch aggregate.
6. Remove accumulated sediment when it has built up to half of the original height of the weir crest.

### **3.8.6 Maintenance**

#### Sediment Removal

While this practice is not intended to be used for sediment trapping, some sediment will accumulate behind the check dam. Periodically inspect check dams and after each significant rainfall. Remove accumulated sediment when it has reached half of the original height of the weir crest.

#### Check Dam Removal

In temporary swales and channels, remove check dams and fill the ditch when it is no longer needed. In permanent channel structures, check dams may be removed when a permanent lining can be installed. In the case of grass lined ditches, check dams may be removed when the grass has matured sufficiently to protect the swale or channel. Seed and mulch the area beneath the check dams immediately after they are removed.



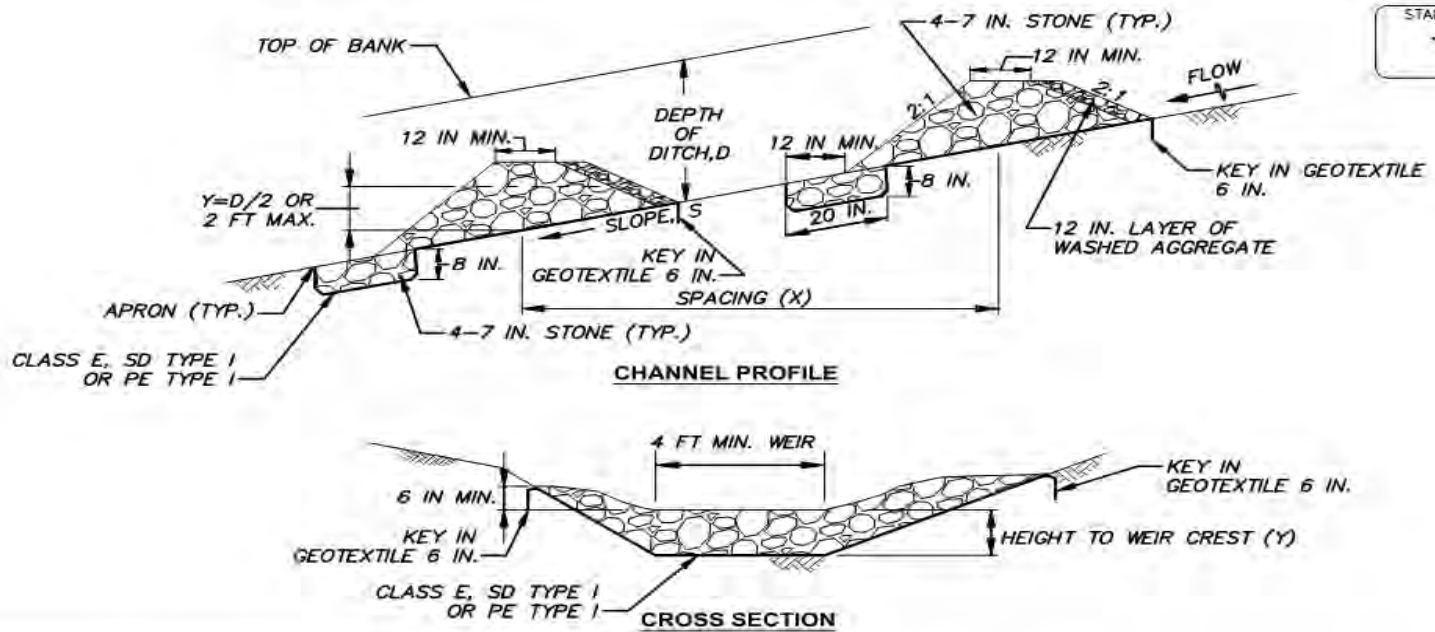

**CONSTRUCTION SPECIFICATIONS**

1. PREPARE SWALES IN ACCORDANCE WITH THE CONSTRUCTION SPECIFICATIONS DESCRIBED IN SECTION 4.4, FOR TEMPORARY SWALE, OR AS SPECIFIED ON PLAN.
2. CONSTRUCT THE CHECK DAM OF 4-7 INCH STONE. PLACE THE STONE SO THAT IT COMPLETELY COVERS THE WIDTH OF THE CHANNEL AND IS KEYED INTO THE CHANNEL BANKS.
3. CONSTRUCT THE TOP OF THE CHECK DAM SO THAT THE CENTER IS APPROXIMATELY 6 INCHES LOWER THAN THE OUTER EDGES, FORMING A WEIR THAT WATER CAN FLOW ACROSS.
4. THE MAXIMUM HEIGHT OF THE CHECK DAM AT THE CENTER MUST NOT EXCEED 2 FEET OR HALF THE HEIGHT OF THE CHANNEL.
5. LINE THE UPSTREAM SIDE OF THE CHECK DAM WITH APPROXIMATELY 1 FOOT OF 3/4 TO 1-1/2 INCH AGGREGATE.
6. REMOVE ACCUMULATED SEDIMENT WHEN IT HAS BUILT UP TO HALF OF THE ORIGINAL HEIGHT OF THE WEIR CREST.

DATE	APPR	
REVISED		
ISSUED:		
	REFERENCE	

**STONE CHECK DAM**

 DISTRICT OF COLUMBIA  
 DEPARTMENT OF ENERGY &  
 ENVIRONMENT

DWG. NO 308.1

## **3.9 Inlet Filter Bags**

### **3.9.1 Description**

Inlet filter bags are geotextile filter bags suspended from inlet grates on either combination inlets or yard inlets.

### **3.9.2 Purpose**

Inlet filter bags are useful where upstream sediment control practices are not expected or able to sufficiently remove sediment.

### **3.9.3 Conditions Where Practice Applies**

Inlet filter bags are a last line of protection for capturing sediment before entering storm drains. Since they are very prone to clogging, additional sediment trapping or filtering practices must be installed upstream of an inlet filter bag. In a particularly sensitive watershed, these may be advised for the additional sediment trapping capacity.

### **3.9.4 Design Criteria**

Protect storm sewer inlets from sediment pollution wherever the sewer system does not discharge into a functioning sediment basin. (NOTE: Since detention ponds do not effectively remove sediment prior to discharging, protect storm sewers discharging to detention ponds from sediment pollution.) Inlet protection may also be desirable in cases where it would be difficult or expensive to clean accumulated sediment from sewer lines, or where a temporary riser may have to be removed from a permanent basin prior to completion of all earthmoving. Maintain inlet protection until all earthwork within the tributary drainage area has been completed and stabilized.

Wherever filter bags are used, install according to the manufacturer's specifications. Provide typical installation details on the drawings.

Note: Filter bags designed to fit over the inlet grate are not recommended for most storm sewer inlets. Use of such filter bags could result in a severe reduction of the inlet capacity resulting in flooding or runoff bypassing the inlet. Wherever such bags are used, they should be located at topographic low points and limited to ½ acre maximum drainage areas. Do not use inlet filter bags as the primary BMP to remove sediment from site runoff water.

Do not use on major paved roadways where ponding may cause traffic hazards.

### **3.9.5 Construction Specifications**

1. Install proprietary filter bag products per manufacturer's recommendations.
2. Geotextile must meet the following specifications:

**Table 3.9 Geotextile Material Properties for Inlet Filter Bag**

Property	Minimum Value	Test Method
Grab Tensile Strength	265 lb	ASTM D-4632
Puncture Strength	100 lb	ASTM D-4833
Mullen Burst Strength	420 psi	ASTM D-3786
Trapezoidal Tear Strength	50 lb	ASTM D-4533
Apparent Opening Size	No. 40 sieve (0.40 mm)	ASTM D-4751
Flow-thru Rate	110 gal/min/ft <sup>2</sup>	ASTM D-4491
UV Resistance after 500 hours	70%	ASTM D-4355

### 3.9.6 Maintenance

Inspect inlet filter bags on a weekly basis or after each rainfall event, whichever is sooner. Clean filter bags and/or replace when the bag is half full. Replace damaged filter bags immediately. Initiate needed repairs immediately after the inspection.

MAXIMUM DRAINAGE AREA = 1/2 ACRE

STANDARD SYMBOL  
F.B.S.

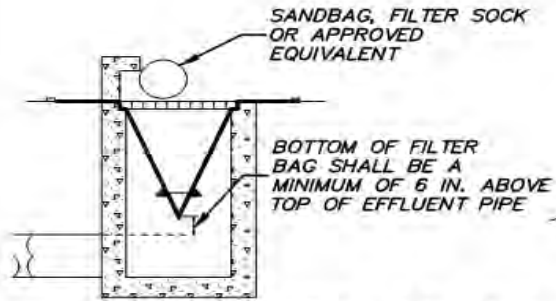

INSTALLATION DETAIL

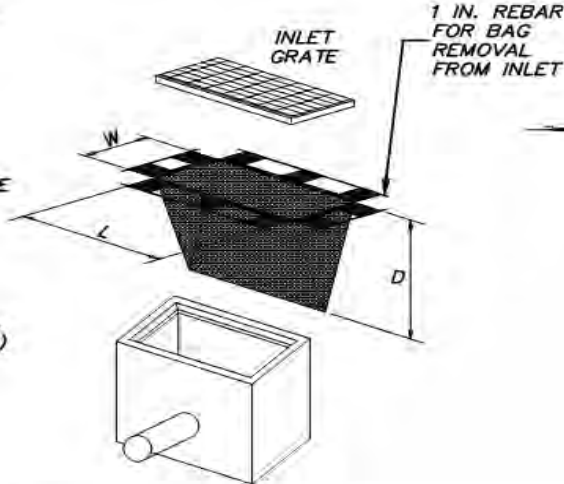

ISOMETRIC VIEW

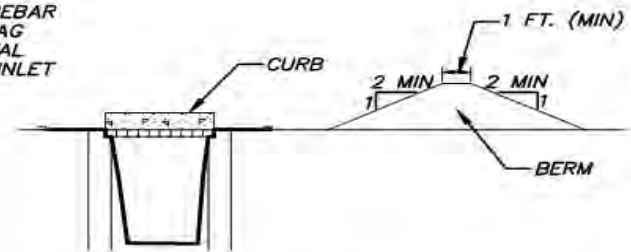

ELEVATION VIEW

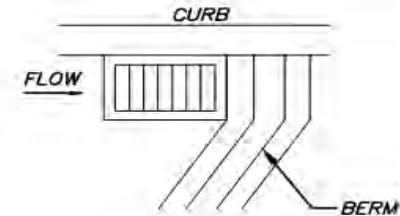

PLAN VIEW

**CONSTRUCTION SPECIFICATIONS**

1. INSTALL PROPRIETARY FILTER BAG PRODUCTS PER MANUFACTURER'S RECOMMENDATIONS.
2. GEOTEXTILE MUST MEET THE SPECIFICATIONS OUTLINED IN TABLE 3.9- GEOTEXTILE MATERIAL PROPERTIES FOR INLET FILTER BAG.
3. INSPECT FILTER BAGS ON A WEEKLY BASIS OR AFTER EACH RAINFALL EVENT, WHICHEVER IS SOONER.
4. CLEAN FILTER BAGS AND/OR REPLACE WHEN THE BAG IS HALF FULL.
5. REPLACE DAMAGED FILTER BAGS IMMEDIATELY.
6. INITIATE NEEDED REPAIRS IMMEDIATELY AFTER THE INSPECTION.

DATE	APPR	
REVISED		
ISSUED:		
	REFERENCE	

**INLET FILTER BAG  
CURBED ROADWAY**



DISTRICT OF COLUMBIA  
DEPARTMENT OF ENERGY &  
ENVIRONMENT

DWG. NO 309.1

SOURCE: 2011 MARYLAND STANDARDS & SPECIFICATIONS

MAXIMUM DRAINAGE AREA = 1/2 ACRE

STANDARD SYMBOL  
F.B.C

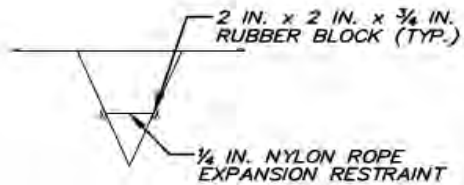
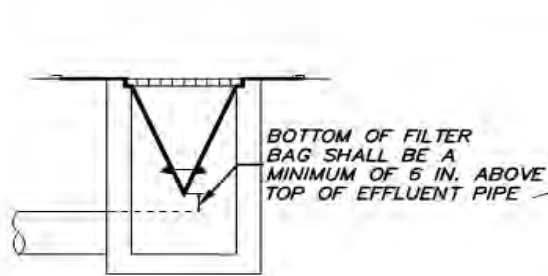

**INSTALLATION DETAIL**

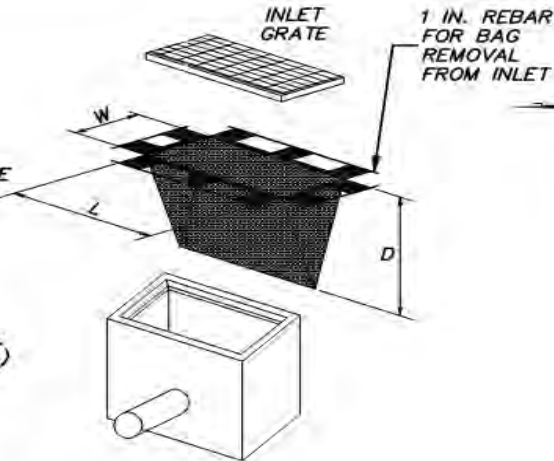

**ISOMETRIC VIEW**

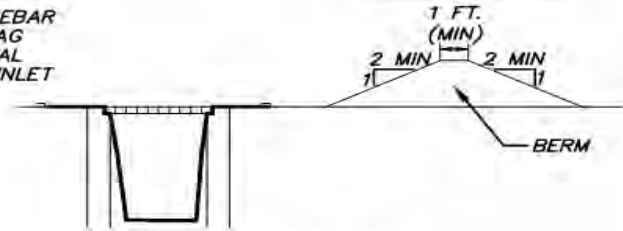

**ELEVATION VIEW**

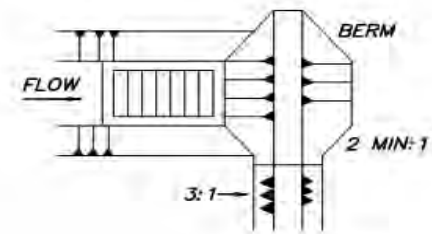

**PLAN VIEW**

**CONSTRUCTION SPECIFICATIONS**

1. INSTALL PROPRIETARY FILTER BAG PRODUCTS PER MANUFACTURER'S RECOMMENDATIONS.
2. GEOTEXTILE MUST MEET THE SPECIFICATIONS OUTLINED IN TABLE 3.9— GEOTEXTILE MATERIAL PROPERTIES FOR INLET FILTER BAG.
3. INSPECT FILTER BAGS ON A WEEKLY BASIS OR AFTER EACH RAINFALL EVENT, WHICHEVER IS SOONER.
4. CLEAN FILTER BAGS AND/OR REPLACE WHEN THE BAG IS HALF FULL.
5. REPLACE DAMAGED FILTER BAGS IMMEDIATELY.
6. INITIATE NEEDED REPAIRS IMMEDIATELY AFTER THE INSPECTION.

DATE	APPR	
REVISED		
ISSUED:		
	REFERENCE	

**INLET FILTER BAG  
CHANNEL OR ROADWAY SWALE**

★ ★ ★ DISTRICT OF COLUMBIA  
DEPARTMENT OF ENERGY & ENVIRONMENT

DWG. NO 309.2

SOURCE: 2011 MARYLAND STANDARDS & SPECIFICATIONS

## 3.10 Silt Fence on Pavement

### 3.10.1 Definition

A temporary barrier of woven geotextile fabric used to intercept, reduce velocity, and filter surface runoff from disturbed areas.

### 3.10.2 Purpose

Silt fence on pavement provides a barrier that can collect and hold debris and soil, preventing the material from entering streams, streets, etc.

### 3.10.3 Conditions Where Practice Applies

Silt fence on pavement is limited to intercepting sheet flow runoff from small disturbed areas when standard silt fence cannot be used. The use of silt fence on pavement is based on the slope length and steepness of the contributing drainage area.

### 3.10.4 Design Criteria

1. Place silt fence on pavement parallel to contours, and extend the ends at least 5 horizontal feet upslope at 45-degree angles relative to the main fence alignment to prevent runoff from flowing around the ends of the silt fence. No section of fence should exceed a grade of 5% for a distance of more than 50 feet.
2. Where ends of the geotextile fabric come together, the overlap, fold, and staple the ends to prevent sediment bypass.
3. Limits imposed by ultraviolet light stability of the fabric will dictate the maximum period that the silt fence may be used.
4. The mastic seal used between the pavement, geotextile, and 2×4 must be non-toxic.
5. Length of the flow contributing to silt fence on pavement must conform to the following limitations:

**Table 3.10 Silt Fence on Pavement Slope Length and Fence Length Constraints**

Slope Steepness	Maximum Slope Length (feet)	Maximum Silt Fence Length (feet)
Flatter than 50:1 (<2%)	250	500
50:1 to 10:1 (2% to 10%)	125	250
10:1 to 5:1 (10% to 20%)	100	200

### 3.10.5 Construction Specifications

1. Use nominal 2-inch by 4-inch lumber.
2. Use woven slit film geotextile, as specified in Appendix A.
3. Space upright supports no more than 10 feet apart.
4. Provide a 2-foot opening between every set of supports and place stone in the opening over geotextile.
5. Keep silt fence taut and securely staple to the upslope side of upright supports. Extend geotextile under  $2 \times 4$ .
6. Where two sections of geotextile adjoin - overlap, fold, and staple to post in accordance with Detail 310.1. Attach lathe.
7. Provide a mastic seal between pavement, geotextile, and  $2 \times 4$  to prevent sediment-laden water from escaping beneath silt fence installation.
8. Secure boards to pavement with 40D 5-inch minimum length nails.
9. Remove accumulated sediment and debris when bulges develop in silt fence or when sediment reaches 25% of fence height. Replace geotextile if torn. Maintain water tight seal along bottom. Replace stone if displaced.

### 3.10.6 Maintenance

Accumulated sediment and debris must be removed when bulges develop in the silt fence or when sediment reaches 25% of the fence height. The geotextile must be replaced if torn. The water tight seal along the bottom must be maintained and the stone replaced if displaced.



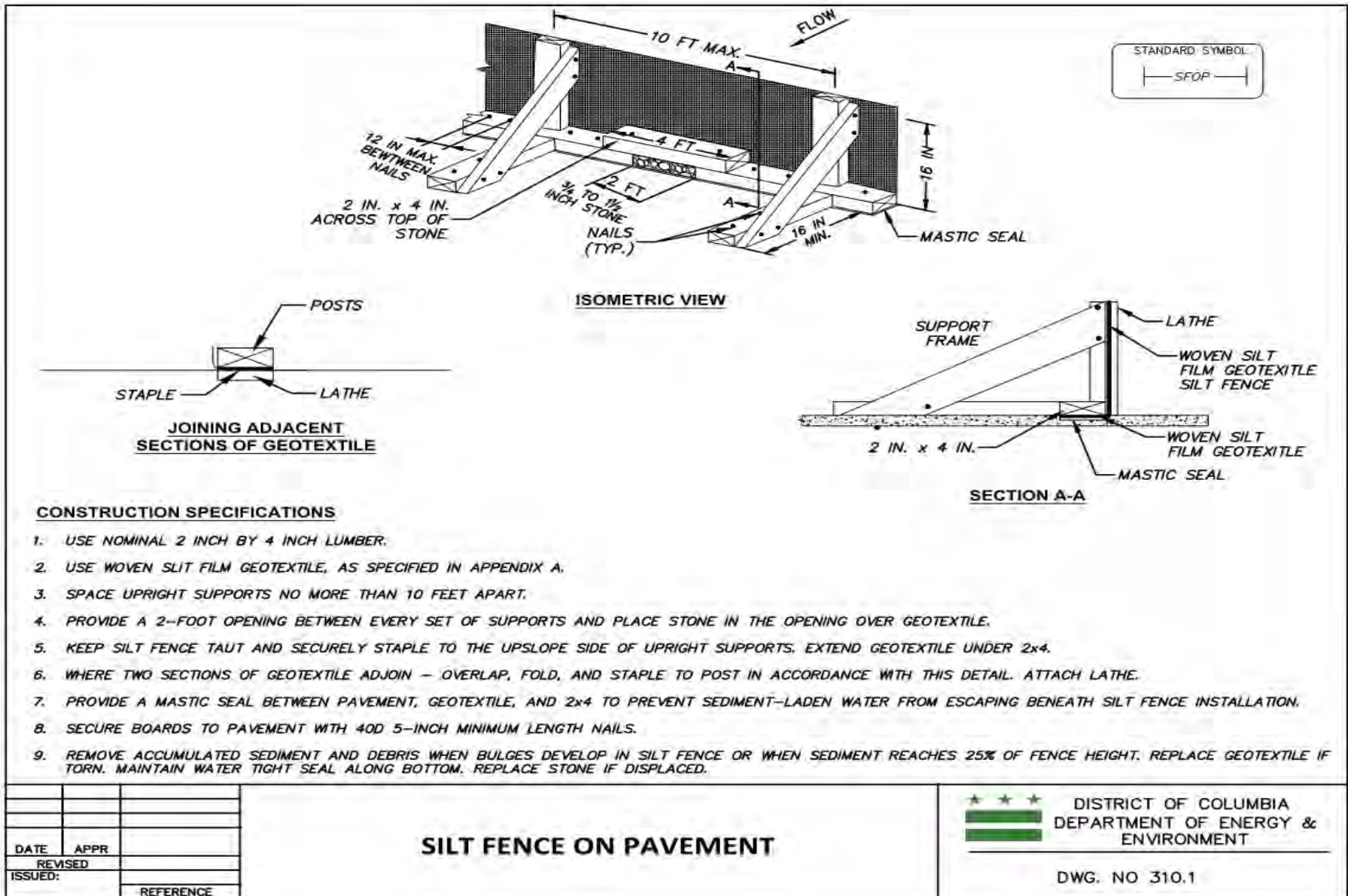

Detail 27 – 310.1 Silt Fence on Pavement



## Chapter 4 Conveyance

### 4.1 Diversion Fence

#### 4.1.1 Definition

A temporary barrier of impermeable sheeting over chain link fence located in such a manner as to direct water to a desired location.

#### 4.1.2 Purpose

To direct sediment-laden runoff to a sediment trapping practice, or to intercept and divert clear water away from disturbed areas.

#### 4.1.3 Conditions Where Practice Applies

Constructed along the limit of disturbance (LOD) or across disturbed areas, use a diversion fence when there is insufficient space to construct an earth dike, temporary swale, or perimeter dike swale.

Appropriate uses of diversion fences include the following:

1. To divert sediment-laden runoff from a disturbed area to a sediment trapping practice.
2. To segment drainage areas for reducing acreage to sediment control practices.
3. To divert clear water from an undisturbed area to a stable outlet at non-erosive velocities.

#### 4.1.4 Design Criteria

1. The maximum slope along fence is 10%.
2. The maximum drainage area is 2 acres.
3. For drainage areas larger than 2 acres, an engineering design may be used based on the 2-year frequency storm with NRCS methodologies (i.e., TR-55, TR-20), assuming the worst soil cover conditions to prevail in the contributing drainage area over the life of the diversion fence.
4. Maintain positive drainage along the entire length of the diversion fence. Spot elevations must be provided for diversion fence having longitudinal slopes flatter than 1%.
5. Discharge velocities from diversion fence must be non-erosive ( $\leq 4$  feet per second).
6. Where diversion fence is used to convey runoff from disturbed areas, the discharge must be to a sediment control practice suitable for concentrated flow. Silt fence and super silt fence are unacceptable for receiving discharges from diversion fence.

7. Where diversion fence is used to convey clear water runoff, the discharge must be to an undisturbed, stable area at a non-erosive velocity ( $\leq 4$  feet per second); otherwise, provide outlet protection.
8. When diversion fence is used in conjunction with a sediment trapping device, sequence construction so that the diversion fence installation follows completion of the sediment trapping device(s).

#### **4.1.5 Construction Specifications**

1. Use 42-inch high, 9 gauge or thicker chain link fencing ( $2\frac{3}{8}$ -inch maximum opening).
2. Use  $2\frac{3}{8}$ -inch diameter galvanized steel posts of 0.095-inch wall thickness and 6-foot length spaced no further than 10 feet apart. The posts do not need to be set in concrete.
3. Fasten chain link fence securely to the fence posts with wire ties.
4. Secure 10-mil or thicker UV-resistant, impermeable sheeting to chain link fence with ties spaced every 24 inches at top, mid-section, and below ground surface.
5. Extend sheeting a minimum of 4 feet along flow surface and embed end a minimum of 8 inches into ground. Soil stabilization matting may be used in lieu of impermeable sheeting along flow surface.
6. When two sections of sheeting adjoin each other, overlap by 6 inches and fold with seam facing downgrade.

#### **4.1.6 Maintenance**

Keep flow surface along diversion fence and point of discharge free of erosion. Remove accumulated sediment and debris. Maintain positive drainage. Replace impermeable sheeting if torn. If undermining occurs, reinstall fence.

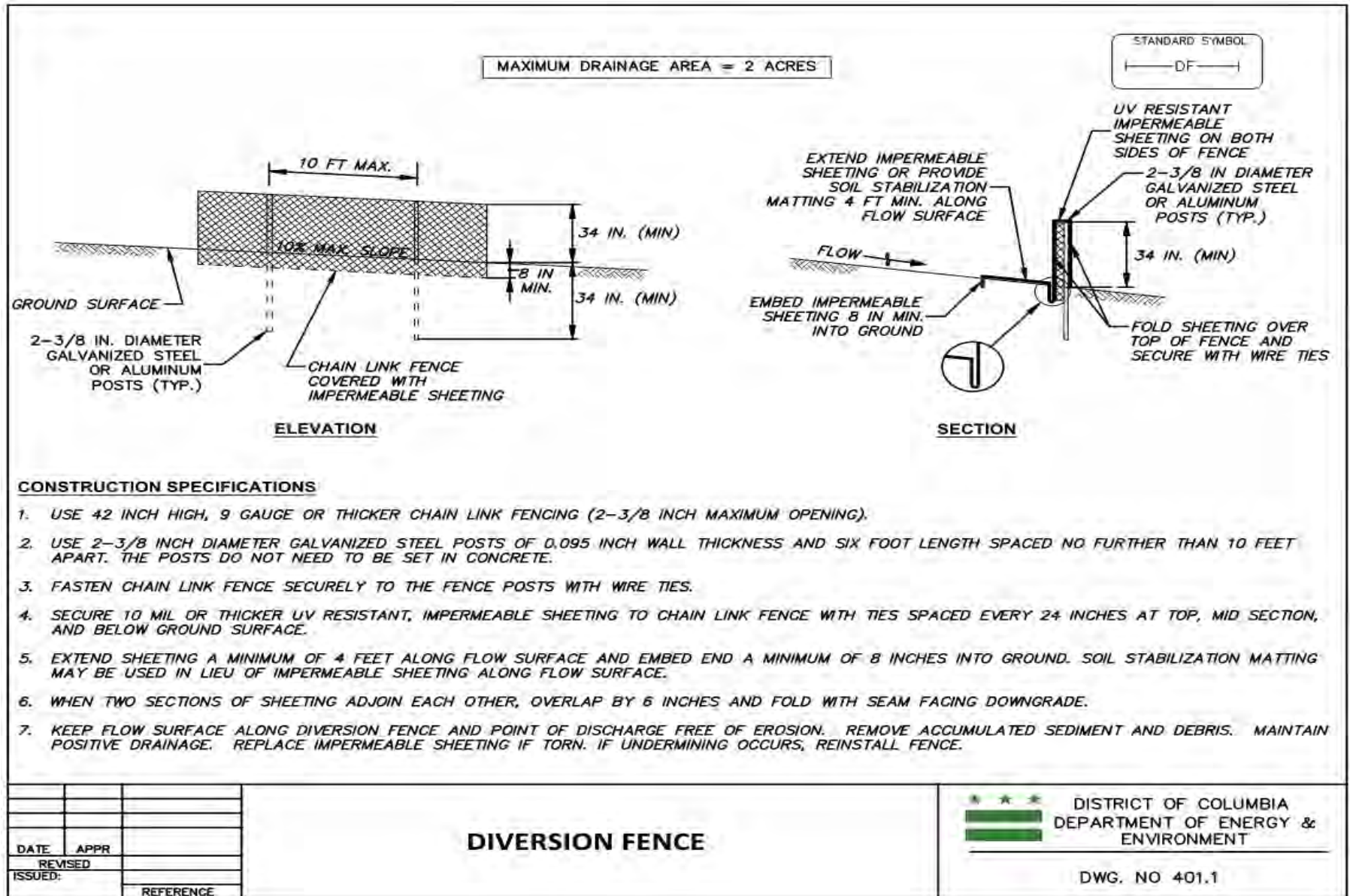

Detail 28 – 401.1 Diversion Fence

## **4.2 Dike/Swale**

### **4.2.1 Definition**

A temporary ridge of soil excavated from an adjoining swale located along the perimeter of the site or disturbed area.

### **4.2.2 Purpose**

The purpose of a perimeter dike/swale is to prevent stormwater runoff from entering a disturbed area and to prevent sediment-laden stormwater runoff from leaving the construction site or disturbed area. Construct a perimeter dike/swale to divert flows around disturbed areas, or along tops of slopes to prevent flows from eroding the slope, or along the base of slopes to direct sediment-laden flows to a trapping device.

### **4.2.3 Conditions Where Practice Applies**

Perimeter dike/swale combinations are often constructed along the border of sites or disturbed areas to divert runoff where necessary. The advantage of a dike/swale is that the excavated soil from the swale portion is immediately placed as fill for the dike adjacent to the excavation, minimizing or eliminating hauling of soils.

### **4.2.4 Design Criteria**

An engineering design is not required for perimeter dike/swale. However, the maximum drainage area for this practice is 2 acres. Engineering design is necessary for larger drainage areas, though the general form of the practice may be used for larger areas, and the practice becomes akin to a pairing of an earth dike and temporary swale immediately adjacent to each other, to balance cut and fill.

Use the following criteria:

1. Drainage area – Less than 2 acres (for drainage areas larger than 2 acres see Section 4.3 Earth Dike or Section 4.4 Temporary Swale).
2. Height – 12 inches minimum from bottom of swale to top of dike evenly divided between dike height and swale depth.
3. Width – Bottom width of dike: 3 feet minimum. Width of swale: 3 feet minimum (see Detail 402.1).
4. Grade – Dependent upon topography, but having positive drainage (sufficient grade to drain) to an adequate outlet. Maximum allowable grade not to exceed 10%.
5. Stabilization – Stabilize the disturbed area of the dike and swale within 7 days of installation, in accordance with Table 4.1.

**Table 4.1 Perimeter Dike/Swale Design Criteria**

PD/S Type	Drainage Area (acres)	Stabilization
PD/S - 1	$\leq 1$	Seed and mulch
PD/S - 2	1–2	Seed and cover with erosion control matting, or line with sod

6. All perimeter dike/swales must have an uninterrupted positive grade to an outlet. Spot elevations may be necessary for grades less than 1%.
7. Convey runoff diverted from a disturbed area to a sediment trapping device.
8. Outlet runoff diverted from an undisturbed area into an undisturbed stabilized area at a non-erosive velocity ( $\leq 4$  feet per second for well-established turfgrass).

#### 4.2.5 Construction Specifications

1. Excavate or shape the swale to line, grade, and cross section as required to meet the criteria specified in the standard.
2. Compact the fill by earth moving equipment in maximum 6-inch lifts, where the height of the fill is greater than 6 inches.
3. Complete the stabilization of the area disturbed by the dike and swale within 7 days and in accordance with the stabilization specifications on the plans (see Section 2.10 Vegetative Stabilization).
4. A perimeter dike/swale must have an outlet that functions without causing erosion.
5. Outlet runoff diverted from a protected or stabilized upland area directly onto an undisturbed stabilized area.
6. Convey runoff diverted from a disturbed or exposed upland area to a sediment trapping device such as a sediment trap or sediment basin.
7. The location of a dike/swale may need to be adjusted in the field in order to provide positive drainage to a trapping device and to utilize the most suitable outlet.

#### 4.2.6 Maintenance

Provide inspection and required maintenance periodically, after each rain event, and daily during a prolonged rain event. Keep dike/swale in place until the disturbed areas are permanently stabilized. Following completion of all construction and stabilization at a site with established vegetation, remove all temporary dike/swales and grade and stabilize the areas occupied by the dike/swales as specified on the plans.

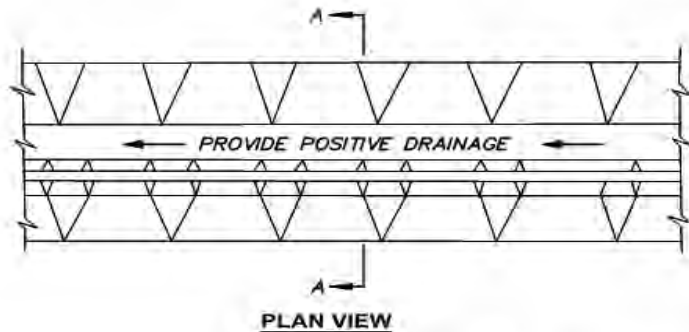

PLAN VIEW

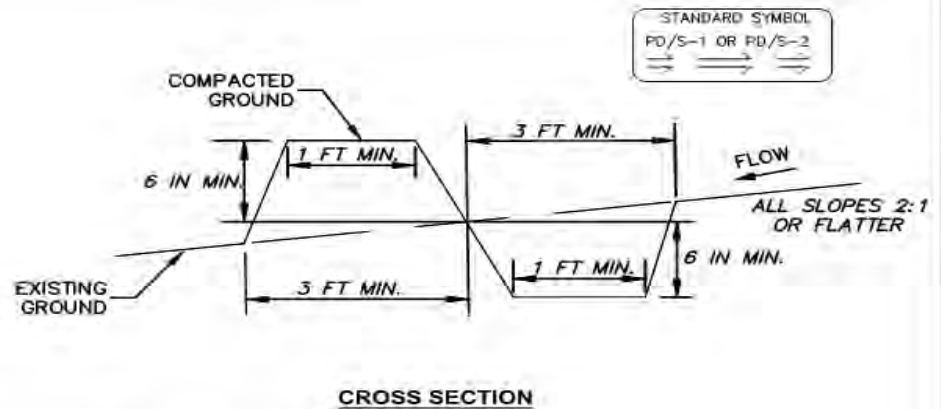

CROSS SECTION

PD/S TYPE	DRAINAGE AREA	STABILIZATION
PD/S-1	≤ 1 ACRE	SEED & MULCH
PD/S-2	1-2 ACRES	SEED COVER W/ EROSION CONTROL MATTING, OR LINE W/ SOD

**CONSTRUCTION SPECIFICATIONS**

1. EXCAVATE OR SHAPE THE SWALE TO LINE, GRADE, AND CROSS SECTION AS REQUIRED TO MEET THE CRITERIA SPECIFIED IN THE STANDARD.
2. COMPACT THE FILL BY EARTH MOVING EQUIPMENT IN MAXIMUM 6-INCH LIFTS, WHERE THE HEIGHT OF THE FILL IS GREATER THAN 6 INCHES.
3. COMPLETE THE STABILIZATION OF THE AREA DISTURBED BY THE DIKE AND SWALE WITHIN 7 DAYS AND IN ACCORDANCE WITH THE STABILIZATION SPECIFICATIONS ON THE PLANS.
4. A PERIMETER DIKE/SWALE MUST HAVE AN OUTLET THAT FUNCTIONS WITHOUT CAUSING EROSION.
5. OUTLET RUNOFF DIVERTED FROM A PROTECTED OR STABILIZED UPLAND AREA DIRECTLY ONTO AN UNDISTURBED STABILIZED AREA.
6. CONVEY RUNOFF DIVERTED FROM A DISTURBED OR EXPOSED UPLAND AREA TO A SEDIMENT TRAPPING DEVICE SUCH AS A SEDIMENT TRAP OR SEDIMENT BASIN.
7. THE LOCATION OF A DIKE/SWALE MAY NEED TO BE ADJUSTED IN THE FIELD IN ORDER TO PROVIDE POSITIVE DRAINAGE TO A TRAPPING DEVICE AND TO UTILIZE THE MOST SUITABLE OUTLET.
8. PROVIDE INSPECTION AND REQUIRED MAINTENANCE PERIODICALLY, AFTER EACH RAIN EVENT, AND DAILY DURING A PROLONGED RAIN EVENT.

DATE	APPR	
REVISED		
ISSUED:		
	REFERENCE	

**DIKE-SWALE**

★ ★ ★ DISTRICT OF COLUMBIA  
 DEPARTMENT OF ENERGY &  
 ENVIRONMENT

DWG. NO 402.1

## 4.3 Earth Dike

### 4.3.1 Definition

A temporary berm or ridge of soil, compacted, stabilized, and located in such a manner as to direct water to an approved location.

### 4.3.2 Purpose

To direct runoff to a sediment trapping device, which reduces the potential for erosion and sedimentation. Earth dikes can also be used for diverting clean water away from disturbed areas.

### 4.3.3 Conditions Where Practice Applies

Earth dikes are often constructed across disturbed areas and around construction sites such as parking lots and subdivisions. The dikes must remain in place until the disturbed areas are permanently stabilized.

Earth dikes are constructed as follows:

1. To divert sediment-laden runoff from a disturbed area to a sediment trapping device.
2. Across disturbed areas to shorten overland flow distances.
3. To divert clear water from an undisturbed area to a stabilized outlet. Runoff must be discharged at non-erosive rates.
4. To be mountable in certain cases; if a runoff diversion practice must be crossed repeatedly by machinery or heavy equipment, the mountable berm modification of the earth dike is recommended. See Construction Specifications item 8 and Detail 403.2.

### 4.3.4 Design Criteria

Table 4.2 shows the basic design criteria for earth dikes. Dike A is for smaller drainage areas. Dike B is for larger drainage areas.

**Table 4.2 Earth Dike Design Criteria**

Criterion	Dike A	Dike B
Drainage Area	(See Table 4.3)	(See Table 4.3)
Slope (of dike)	(See Table 4.3)	(See Table 4.3)
Dike Height (a)	18 inches	30 inches
Dike Width (b)	24 inches	36 inches
Flow Width (c)	4 feet	6 feet
Flow Depth in Channel (d)	12 inches	24 inches
Side Slopes	2:1 or flatter	2:1 or flatter

### Directions for Using Table 4.3

1. Determine the location on the Erosion and Sediment Control plan where it is feasible to use the earth dike to divert runoff. Determine the longitudinal slopes of the proposed temporary earth dike location.
2. Determine the maximum drainage area to various design points along the proposed earth dike alignment.
3. Enter Table 4.3 with the slope and drainage area corresponding to the previously determined design points along the earth dike. Using Table 4.3, choose an earth dike type (A or B) and lining (1, 2, or 3), for the earth dike alignment between the design points. Always use the higher standard if design variables fall between two defined values. For example, a 2-acre drainage area with a 9.5% longitudinal slope along the swale alignment will require an A-3 swale and lining combination.
4. Review the slopes along the earth dike alignment between the design points to ensure that the slope/drainage area relationship does not exceed the chosen lining.

### Stabilization

Complete the stabilization of the earth dike within 7 days of installation in accordance with the Section 2.10 Vegetative Stabilization. Stabilize the earth dike flow channel in accordance with Table 4.3, per one of the following options:

#### Flow Channel Stabilization Lining (based on Table 4.3)

1. Seed and cover with straw mulch.
2. Seed and cover with erosion control matting, or line with sod.
3. Use 4 to 7-inch stone or recycled concrete equivalent pressed into the soil using construction equipment in a minimum 7-inch layer.

Show the earth dike type (A or B) and lining type (1, 2, or 3) on the plans using the standard symbol and A-1, or B-3, etc. Earth dike type and lining may vary along its length based on necessary runoff carrying capacity.

In highly erodible soils, as defined by the local approval agency, refer to the next higher slope grade for the type of stabilization needed.



**Table 4.3 Earth Dike Selection Criteria**

Slope % **	Drainage Area (acres)										
	1	2	3	4	5	6	7	8	9	10	
1	[1] Seed and mulch		4					B-2			
2		4									
3	A-1							6	6	6	
4	4*	[2] Seed and soil stabilization matting					6				
5					6	6			B-3		
6		A-2		6		A-3					
7			6								
8				[3] 4- to 7-inch stone Pressed into ground (7 inches min.)							
9											
10		6*									

**DIKE A**      **DIKE B**

\* Velocity of discharge in feet/second

\*\* For slopes steeper than 10%, refer to Appendix B Open Channel Hydraulics and potentially Section 4.5 Long-Term or Permanent Flumes/Chutes and Section 4.6 Permanent Channel.

### Important Notes

For slopes or drainage areas greater than specified on Table 4.3, an engineering design is required. If the slope of the earth dike or the contributing drainage area falls between values on Table 4.3, round up to the next higher slope or drainage area.

Engineering design may preempt the use of Table 4.3. Use the NRCS criteria for the engineering design of the 2-year frequency storm, assuming the worst soil cover conditions to prevail in the contributing drainage area over the life of the earth dike. Use Manning's Equation to determine earth dike flow channel velocities associated with the developed discharges. See Table 4.4 for Design Criteria Based on Stabilization Type.

**Table 4.4 Design Criteria Based on Stabilization Type**

Stabilization Type	Manning's Roughness Coefficient	Allowable Flow Channel Velocity (fps)
Seed and mulch	0.025	< 2
Sod	0.030	< 4
Soil stabilization matting over seed and mulch	0.030	< 6
Established grass with permanent soil stabilization matting	0.040	< 8
4 to 7-inch stone, flow depths up to 1 foot (Dike A)	0.045	< 10
4 to 7-inch stone, flow depths between 1 and 2 feet (Dike B)	0.038	< 12

For basic guidance on using Manning's Equation for open channel flow, refer to Appendix B – Open Channel Hydraulics; whether temporary or permanent, the same flow and channel characteristics apply.

#### Outlet

1. Earth dikes must have an outlet that functions without causing erosion.
2. Convey runoff from disturbed areas to a sediment trapping device such as a sediment trap or sediment basin until the drainage area above the earth dike is adequately stabilized.
3. The on-site location may need to be adjusted to meet field conditions.
4. Discharge clear water diversions around disturbed area into an undisturbed, stabilized area or watercourse at a non-erosive velocity.

### **4.3.5 Construction Specifications**

#### Earth Dike

1. All temporary earth dikes must have uninterrupted positive grade to an outlet. Earth dikes having longitudinal slopes flatter than 1% should have spot elevations along the flow line.
2. Direct diverted runoff from disturbed areas to a sediment trapping device.
3. Outlet diverted runoff from undisturbed areas directly onto an undisturbed, stabilized area at a non-erosive velocity ( $\leq 4$  feet per second for well-established turfgrass).
4. Remove and dispose of all trees, brush, stumps, obstructions, and other objectionable material so as not to interfere with the proper functioning of the earth dike berm and flow channel.
5. Excavate or shape the dike to line, grade, and cross section as required to meet the criteria specified herein and be free of bank projections or other irregularities which will impede normal flow.
6. Compact the fill by earth moving equipment in maximum 12-inch lifts.

7. Place all earth removed and not needed for construction so that it will not interfere with the functioning of the earth dike berm and flow channel.
8. Stabilize flow channel as required by design selection using Table 4.3 or Table 4.4. Stone lining must have geotextile underlayment of Class SD Type I non-woven or PE Type I non-woven fabric.

#### Mountable Berm

1. For a mountable berm section, see Detail 403.2.
2. Use minimum width of 10 feet to allow for vehicular passage.
3. Place non-woven geotextile of Class SD Type I non-woven or PE Type I non-woven fabric over the earth mound prior to placing stone. If the flow channel lining necessary according to Table 4.3 and the channel characteristics is 4 to 7-inch stone, install this as the base layer, and apply the 2 to 3-inch stone for the mountable berm on top of the 4 to 7-inch stone for the vehicle crossing surface maintaining a smooth flow path line. The geotextile underlayment is only necessary where there is not already a stone base.
4. Place 2 to 3-inch stone or equivalent recycled concrete at least 6 inches deep over the length and width of the mountable berm. Ensure a smooth transition to and from the flow channel above and below the mountable berm section.
5. Maintain line, grade, and cross section. Add stone or make other repairs as conditions demand to maintain specified dimensions. Remove accumulated sediment and debris. Maintain positive drainage.

#### **4.3.6 Maintenance**

Provide inspection and maintenance periodically, after each rain event, and daily during a prolonged rain event.

Following completion of all construction and stabilization at a site with established vegetation, remove all temporary earth dikes and the areas occupied by the dikes must be graded and stabilized with vegetation.

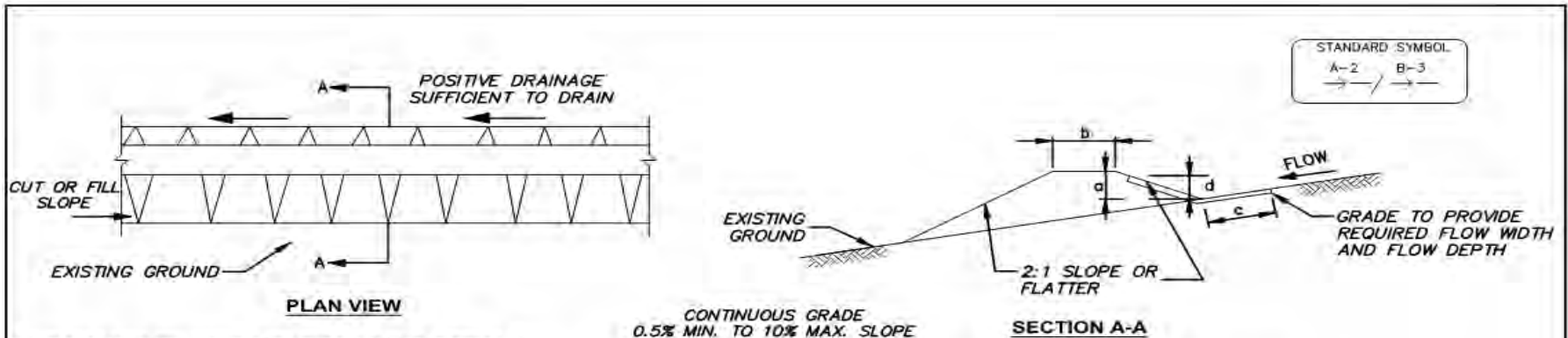

**FLOW CHANNEL STABILIZATION LINING OPTIONS**

GRADE 0.5% MIN. 10% MAX

1. SEED AND COVER WITH STRAW MULCH.
2. SEED AND COVER WITH EROSION CONTROL MATTING, OR LINE WITH SOD.
3. 4 TO 7-INCH STONE OR RECYCLED CONCRETE EQUIVALENT PRESSED INTO SOIL USING CONSTRUCTION EQUIPMENT IN A MINIMUM 7-INCH LAYER.

**CONSTRUCTION SPECIFICATIONS**

1. ALL TEMPORARY EARTH DIKES MUST HAVE UNINTERRUPTED POSITIVE GRADE TO AN OUTLET. EARTH DIKES HAVING LONGITUDINAL SLOPES FLATTER THAN 1% SHOULD HAVE SPOT ELEVATIONS ALONG THE FLOW LINE.
2. DIRECT DIVERTED RUNOFF FROM DISTURBED AREAS TO A SEDIMENT TRAPPING DEVICE.
3. OUTLET DIVERTED RUNOFF FROM UNDISTURBED AREAS DIRECTLY ONTO AN UNDISTURBED, STABILIZED AREA AT A NON-EROSIVE VELOCITY ( $\leq$  4 FEET PER SECOND FOR WELL-ESTABLISHED TURFGRASS).
4. REMOVE AND DISPOSE OF ALL TREES, BRUSH, STUMPS, OBSTRUCTIONS, AND OTHER OBJECTIONABLE MATERIAL SO AS NOT TO INTERFERE WITH THE PROPER FUNCTIONING OF THE EARTH DIKE BERM AND FLOW CHANNEL.
5. EXCAVATE OR SHAPE THE DIKE TO LINE, GRADE, AND CROSS SECTION AS REQUIRED TO MEET THE CRITERIA SPECIFIED HEREIN AND BE FREE OF BANK PROJECTIONS OR OTHER IRREGULARITIES WHICH WILL IMPEDE NORMAL FLOW.
6. COMPACT THE FILL BY EARTH MOVING EQUIPMENT IN MAXIMUM 12-INCH LIFTS.
7. PLACE ALL EARTH REMOVED AND NOT NEEDED FOR CONSTRUCTION SO THAT IT WILL NOT INTERFERE WITH THE FUNCTIONING OF THE EARTH DIKE BERM AND FLOW CHANNEL.
8. STABILIZE FLOW CHANNEL AS REQUIRED BY DESIGN SELECTION USING TABLE 4.3 OR TABLE 4.4. STONE LINING MUST HAVE GEOTEXTILE UNDERLAYMENT OF CLASS SD TYPE I NON-WOVEN OR PE TYPE I NON-WOVEN FABRIC.
9. PROVIDE INSPECTION AND MAINTENANCE PERIODICALLY, AFTER EACH RAIN EVENT, AND DAILY DURING A PROLONGED RAIN EVENT.

CONTINUOUS GRADE  
0.5% MIN. TO 10% MAX. SLOPE

**SECTION A-A**

**DIKE TYPE**

	A	B
a - DIKE HEIGHT	18 IN MIN.	30 IN MIN.
b - DIKE WIDTH	24 IN MIN.	36 IN MIN.
c - FLOW WIDTH	4 FT MIN.	6 FT MIN.
d - FLOW DEPTH	12 IN MIN.	24 IN MIN.

DATE	APPR	
REVISED		
ISSUED:		
		REFERENCE

**EARTH DIKE - 1**

★ ★ ★ DISTRICT OF COLUMBIA  
DEPARTMENT OF ENERGY &  
ENVIRONMENT

DWG. NO 403.1

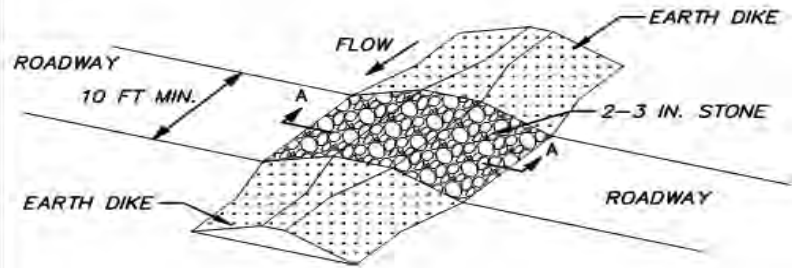
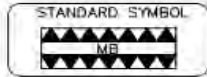

**ISOMETRIC VIEW**

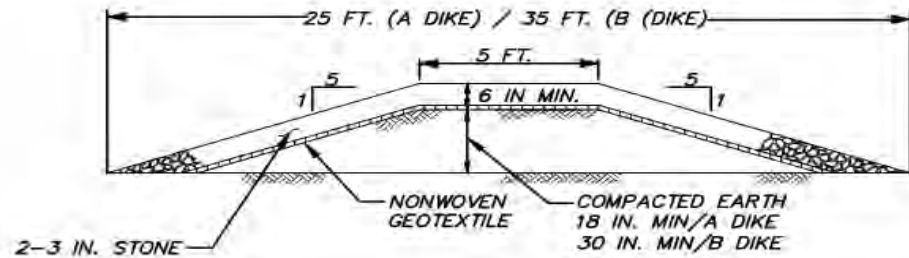

**SECTION A-A**

**CONSTRUCTION SPECIFICATIONS**

1. USE MINIMUM WIDTH OF 10 FEET TO ALLOW FOR VEHICULAR PASSAGE.
2. PLACE NON-WOVEN GEOTEXTILE OF CLASS SD TYPE I NON-WOVEN OR PE TYPE I NON-WOVEN FABRIC OVER THE EARTH MOUND PRIOR TO PLACING STONE. IF THE FLOW CHANNEL LINING NECESSARY ACCORDING TO TABLE 4.3 AND THE CHANNEL CHARACTERISTICS IS 4 TO 7-INCH STONE, INSTALL THIS AS THE BASE LAYER, AND APPLY THE 2 TO 3-INCH STONE FOR THE MOUNTABLE BERM ON TOP OF THE 4 TO 7-INCH STONE FOR THE VEHICLE CROSSING SURFACE MAINTAINING A SMOOTH FLOW PATH LINE. THE GEOTEXTILE UNDERLAYMENT IS ONLY NECESSARY WHERE THERE IS NOT ALREADY A STONE BASE.
3. PLACE 2 TO 3-INCH STONE OR EQUIVALENT RECYCLED CONCRETE AT LEAST 6 INCHES DEEP OVER THE LENGTH AND WIDTH OF THE MOUNTABLE BERM. ENSURE A SMOOTH TRANSITION TO AND FROM THE FLOW CHANNEL ABOVE AND BELOW THE MOUNTABLE BERM SECTION.
4. MAINTAIN LINE, GRADE, AND CROSS SECTION. ADD STONE OR MAKE OTHER REPAIRS AS CONDITIONS DEMAND TO MAINTAIN SPECIFIED DIMENSIONS. REMOVE ACCUMULATED SEDIMENT AND DEBRIS. MAINTAIN POSITIVE DRAINAGE.
5. PROVIDE INSPECTION AND MAINTENANCE PERIODICALLY, AFTER EACH RAIN EVENT, AND DAILY DURING A PROLONGED RAIN EVENT.

DATE	APPR	
ISSUED:		
		REFERENCE

**EARTH DIKE - 2  
MOUNTABLE BERM**

★ ★ ★ DISTRICT OF COLUMBIA  
DEPARTMENT OF ENERGY &  
ENVIRONMENT

DWG. NO 403.2

SOURCE: 2011 MARYLAND STANDARDS & SPECIFICATIONS

## 4.4 Temporary Swales

### 4.4.1 Definition

A temporary, excavated drainage way constructed and located to convey runoff to an approved location.

### 4.4.2 Purpose

The purpose of a temporary swale is to prevent runoff from entering disturbed areas by intercepting and diverting it to a stabilized outlet or to intercept sediment-laden water and divert it to a sediment-trapping device.

### 4.4.3 Conditions Where Practice Applies

Temporary swales are constructed as follows:

1. To divert sediment-laden runoff from a disturbed area to a sediment trapping device.
2. Across disturbed areas to shorten overland flow distances.
3. To direct sediment-laden water along the base of slopes to a sediment trapping device.
4. To divert clear water from an undisturbed area to a stabilized outlet. Discharge runoff at non-erosive rates.

For vehicular crossing requirements, refer to Section 4.3 Earth Dike option for mountable berm, and Detail 403.2, or Construction Specifications item 8 below.

### 4.4.4 Design Criteria

Table 4.5 shows the basic design criteria for temporary swales. Swale A is for smaller drainage areas. Swale B is for larger drainage areas.

**Table 4.5 Temporary Swale Design Criteria**

Criterion	Swale A	Swale B
Drainage Area	(see Table 4.6)	(see Table 4.6)
Slope (of swale)	(see Table 4.6)	(see Table 4.6)
Bottom Width of Flow Channel	4 feet minimum	6 feet minimum
Depth of Flow Channel	1 foot minimum	1 foot minimum
Side Slopes	2:1 or flatter	2:1 or flatter

Directions for Using Table 4.6

1. Determine the location on the Erosion and Sediment Control plan where using the temporary swale to divert runoff is feasible. Determine the longitudinal slopes of the proposed temporary swale location.
2. Determine the maximum drainage area to various design points along the proposed temporary swale alignment.
3. Enter Table 4.6 with the slope and drainage area corresponding to the previously determined design points along the earth dike. Using the tables, choose an appropriate swale type (A or B) and lining (1, 2, or 3) for the alignment between the design points. Always use the higher standard if design variables fall between two defined values. For example, a 6-acre drainage area with a 5.5% longitudinal slope along the swale alignment will require a B-3 swale and lining combination.
4. Review the slopes along the earth dike alignment between the design points to ensure that the slope/drainage area relationship does not exceed the chosen lining.

**Table 4.6 Temporary Swale Selection Criteria**

Slope %	Drainage Area (acres)									
	1	2	3	4	5	6	7	8	9	10
1	[1] Seed and mulch					4		B-2		
2	A-1		4	4	4					
3		4							6	6
4			[2] Seed and soil stabilization matting					6		
5	4*		[2] Seed and soil stabilization matting				6		B-3	
6			A-2			6				
7					6					
8				6			[3] 4- to 7-inch stone pressed into ground (7 inches min.)			
9					A-3		[3] 4- to 7-inch stone pressed into ground (7 inches min.)			
10			6*							



\*Velocity of flow in feet/second

Stabilization

Complete stabilization of the temporary swale within 7 days of installation in accordance with Section 2.10 Vegetative Stabilization. Stabilize the temporary swale flow channel in accordance with Table 4.6 and the following criteria:

Flow Channel Stabilization (based on Table 4.6)

1. Seed and cover with straw mulch.
2. Seed and cover with erosion control matting or line with sod.
3. Use 4 to 7-inch stone or recycled concrete equivalent pressed into the soil in a minimum 7-inch layer.

Show the temporary swale type (A or B) and lining (1, 2, or 3) on the plans using the standard symbol and A-1, or B-3, etc. Temporary swale type and lining may vary along its length.

In highly erodible soils, as defined by the local approval agency, refer to the next higher slope grade for the type of stabilization needed.

Important Notes

For slopes or drainage areas greater than specified on Table 4.6, an engineering design is required. If the slope of the swale or the contributing drainage area falls between values on Table 4.6, round up to the next higher slope or drainage area.

Engineering design may preempt the use of Table 4.6. Use the NRCS criteria for the engineering design of the 2-year frequency storm, assuming the worst soil cover conditions to prevail in the contributing drainage area over the life of the temporary swale. Use Manning's Equation to determine temporary swale flow channel velocities associated with the developed discharges. See Table 4.4 (revisited below) for Design Criteria based on Stabilization Type. For site conditions exceeding those where temporary swale criteria apply, refer to Appendix B – Open Channel Hydraulics, Section 4.5 Long-Term or Permanent Flumes/Chutes, and Section 4.6 Permanent Channel.

**Table 4.4: Design Criteria based on Stabilization Type**

Stabilization Type	Manning's Roughness Coefficient	Allowable Flow Channel Velocity (feet/second)
Seed and mulch	0.025	< 2
Sod	0.03	< 4
Soil stabilization matting over seed and mulch	0.03	< 6
Grass with permanent soil stabilization matting	0.04	< 8
4-inch to 7-inch stone, flow depths up to 1 foot	0.045	< 10
4-inch to 7-inch stone, flow depths between 1 and 2 feet	0.038	< 12



For basic guidance on using Manning's Equation for open channel flow, refer to Appendix B – Open Channel Hydraulics; whether temporary or permanent, the same flow and channel characteristics apply.

### Outlet

1. Temporary swales must have an outlet that functions without causing erosion.
2. Convey runoff from disturbed areas to a sediment trapping device such as a sediment trap or sediment basin until the drainage area above the swale is adequately stabilized.
3. The location may need to be adjusted to meet field conditions.
4. Discharge clear water diversions around disturbed areas onto an undisturbed, stabilized area or watercourse at a non-erosive velocity.

### **4.4.5 Construction Specifications**

1. All temporary swales must have uninterrupted positive grade to an outlet. Swales having longitudinal slopes flatter than 1% should have spot elevations along the flow line.
2. Convey diverted runoff from disturbed areas to a sediment trapping device.
3. Outlet diverted runoff from an undisturbed area directly into an undisturbed stabilized area at a non-erosive velocity ( $\leq 4$  feet per second for well-established turfgrass).
4. Remove and dispose of all trees, brush, stumps, obstructions, and other objectionable material so as not to interfere with the proper functioning of the swale flow channel.
5. Excavate or shape the swale to line, grade, and cross section as required to meet the criteria specified herein and be free of bank projections or other irregularities that will impede normal flow.
6. Compact fill, if necessary, by earth moving equipment in maximum 12-inch lifts.
7. Place all earth removed and not needed for construction so that it will not interfere with the functioning of the swale flow channel.
8. For vehicle or machine crossings, reduce the side slopes of the swale to 5:1 horizontal to vertical, and 2 to 3-inch stone must be placed at least 6 inches deep over a layer of Class SD Type I or PE Type I non-woven geotextile. If the flow channel lining material is type 3 (4 to 7-inch stone), the geotextile is not required, and the 2 to 3-inch stone can be laid directly on top of the 4 to 7-inch stone lining. Flow channel depth of 1 foot minimum must be maintained through cross section.

### **4.4.6 Maintenance**

Inspection and maintenance must be provided periodically, after each rain event, and daily during a prolonged rain event.

Following completion of all construction and stabilization at a site with established vegetation, remove all temporary earth swales and grade and stabilize the areas occupied by the swales with vegetation.

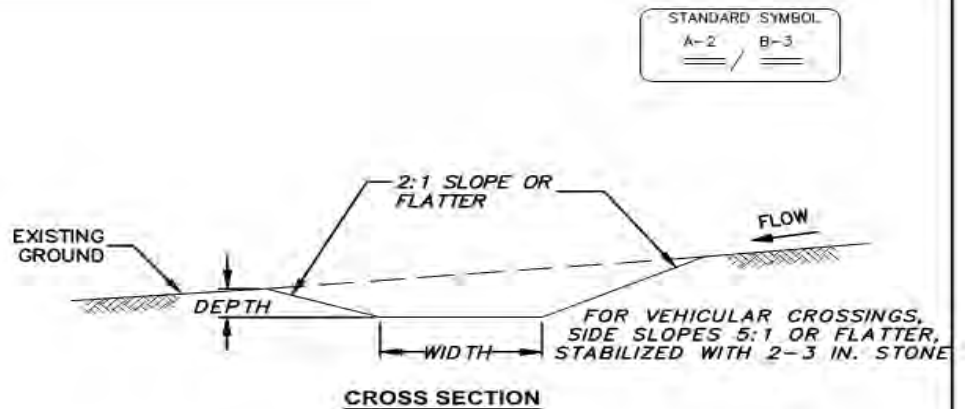
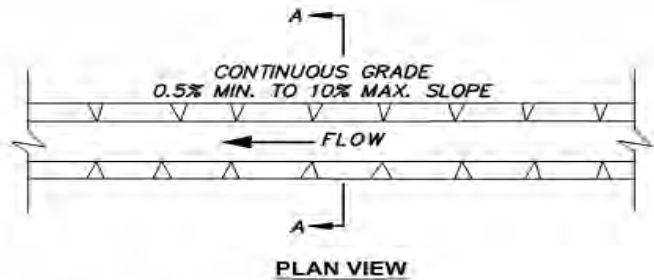

**FLOW CHANNEL STABILIZATION LINING OPTIONS**

GRADE 0.5% MIN. 10% MAX

1. SEED AND COVER WITH STRAW MULCH.
2. SEED AND COVER WITH EROSION CONTROL MATTING OR LIME WITH SOD.
3. 4 TO 7-INCH STONE OR RECYCLED CONCRETE EQUIVALENT PRESSED INTO SOIL IN A MINIMUM 7-INCH LAYER.

**CONSTRUCTION SPECIFICATIONS**

1. ALL TEMPORARY SWALES MUST HAVE UNINTERRUPTED POSITIVE GRADE TO AN OUTLET. SWALES HAVING LONGITUDINAL SLOPES FLATTER THAN 1% SHOULD HAVE SPOT ELEVATIONS ALONG THE FLOW LINE.
2. CONVEY DIVERTED RUNOFF FROM DISTURBED AREAS TO A SEDIMENT TRAPPING DEVICE.
3. OUTLET DIVERTED RUNOFF FROM AN UNDISTURBED AREA DIRECTLY INTO AN UNDISTURBED STABILIZED AREA AT A NON-EROSIVE VELOCITY ( $\approx$  4 FEET PER SECOND FOR WELL-ESTABLISHED TURFGRASS).
4. REMOVE AND DISPOSE OF ALL TREES, BRUSH, STUMPS, OBSTRUCTIONS, AND OTHER OBJECTIONABLE MATERIAL SO AS NOT TO INTERFERE WITH THE PROPER FUNCTIONING OF THE SWALE FLOW CHANNEL.
5. EXCAVATE OR SHAPE THE SWALE TO LINE, GRADE AND CROSS SECTION AS REQUIRED TO MEET THE CRITERIA SPECIFIED HEREIN AND BE FREE OF BANK PROJECTIONS OR OTHER IRREGULARITIES THAT WILL IMPEDE NORMAL FLOW.
6. COMPACT FILL, IF NECESSARY, BY EARTH MOVING EQUIPMENT IN MAXIMUM 12-INCH LIFTS.
7. PLACE ALL EARTH REMOVED AND NOT NEEDED FOR CONSTRUCTION SO THAT IT WILL NOT INTERFERE WITH THE FUNCTIONING OF THE SWALE FLOW CHANNEL.
8. FOR VEHICLE OR MACHINE CROSSINGS, REDUCE THE SIDE SLOPES OF THE SWALE TO 5:1 HORIZONTAL TO VERTICAL, AND 2 TO 3-INCH STONE MUST BE PLACED AT LEAST 6 INCHES DEEP OVER A LAYER OF CLASS SD TYPE 1 OR PE TYPE 1 NON-WOVEN GEOTEXTILE. IF THE FLOW CHANNEL LINING MATERIAL IS TYPE 3 (4 TO 7-INCH STONE), THE GEOTEXTILE IS NOT REQUIRED, AND THE 2 TO 3-INCH STONE CAN BE LAID DIRECTLY ON TOP OF THE 4 TO 7-INCH STONE LINING. FLOW CHANNEL DEPTH OF 1 FT MINIMUM MUST BE MAINTAINED THROUGH CROSS SECTION.

	<b>SWALE TYPE</b>	
	<b>A</b>	<b>B</b>
MIN. DEPTH	1 FT MIN.	1 FT MIN.
BOTTOM WIDTH	4 FT MIN.	6 FT MIN.

DATE	APPR	
	REVISED	
ISSUED:		
	REFERENCE	

**TEMPORARY SWALES**

DISTRICT OF COLUMBIA  
 DEPARTMENT OF ENERGY &  
 ENVIRONMENT

DWG. NO 404.1

SOURCE: 2011 MARYLAND STANDARDS & SPECIFICATIONS

Detail 32 – 404.1 Temporary Swales

## **4.5 Long Term or Permanent Flumes, Chutes**

### **4.5.1 Definition**

A paved, stone-lined, or gabion-lined channel constructed on a slope.

### **4.5.2 Purpose**

To conduct stormwater runoff safely down the face of a slope without causing erosion problems on or below the slope.

### **4.5.3 Conditions Where Practice Applies**

For temporary installation, a pipe slope drain may be suitable. See Section 4.7 Pipe Slope Drain.

Wherever concentrated stormwater runoff must be conveyed from the top to the bottom of cut or fill slopes on a long-term or permanent basis. Where feasibility allows choice, preference for chute lining material is:

1. Riprap – not as susceptible to hydrostatic uplift as concrete; slows runoff and allows some water to pass through; if removed, does not leave metal debris
2. Gabions (or Reno Mattresses) – not as susceptible to hydrostatic uplift as concrete; slows runoff and allows some water to pass through
3. Concrete – practically impermeable; stable if base is constructed properly

### **4.5.4 Design Criteria**

Long-term or permanent flumes are used routinely on highway cuts and fills to convey concentrated stormwater runoff from the top to the bottom of the slope without erosion. Standards and specifications have been developed for these structures which apply to all secondary and primary highway construction projects. These structures have equal applicability to cut-and-fill slopes for construction projects other than highways.

Consideration must be given to protecting concrete structures against buoyancy failures. The potential for buoyancy failures due to hydrostatic uplift forces exists in channels constructed in periodically saturated areas (all channels will experience saturation of the subgrade by virtue of the function of the channel) and especially if a submerged outfall condition exists. Addition of drain tile (French drain) near the chute may alleviate the potentially damaging hydrostatic conditions (see Figure 4.1).

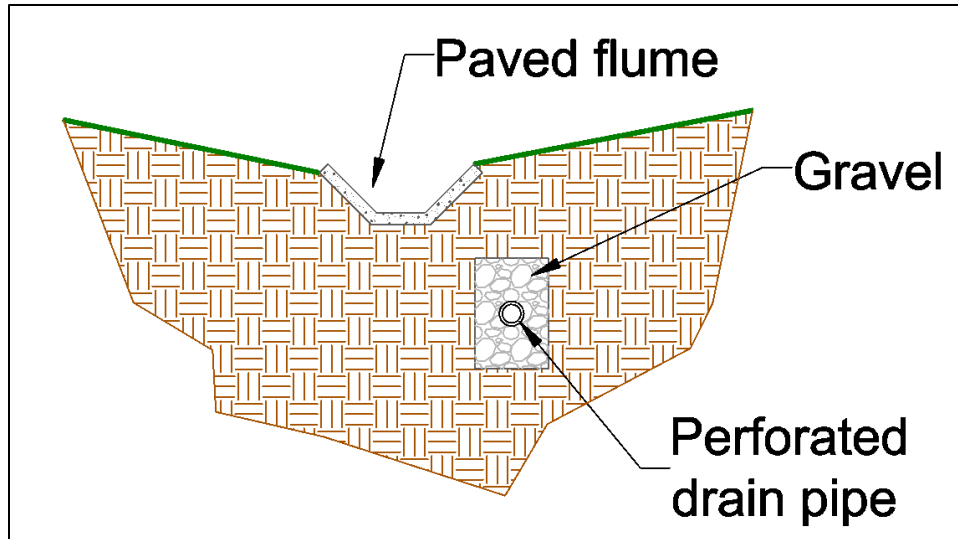

**Figure 4.1 Paved flume with french drain.**

Paved flumes should be utilized and constructed carefully. Field experience has shown a significant amount of post-construction problems with these controls. If the base contains some unsuitable material or is too "soft," the flume will be subject to undermining and fracturing. There are also many cases where the outlet velocities and stormwater flow rates traveling in a paved flume are so great that erosion and flooding at the end of the structure are inevitable, no matter what type of treatment is installed at the outlet.

In these cases, consider a riprap or gabion mattress channel, or a system of inlets, manholes, and pipes to safely convey the stormwater to the receiving channel or drainage structure.

### Riprap Flumes

General design constraints and guidance can be found in Section 4.6 Permanent Channel, Appendix B Open Channel Hydraulics, and Section 5.1 Rock Outlet Protection.

1. Flumes must pass 125% of the peak flow expected from a 15-year frequency storm. Maximum carrying capacity in Table 4.7 is for a riprap or gabion flume, with cross section as shown in Figure 4.2, and a Manning's roughness coefficient determined by the following equation:

$$n = \frac{d^{\frac{1}{6}}}{21.6 \times \log_{10} \left( \frac{d}{D_{50}} \right) + 14.0}$$

This method sets depth to 1 foot for the example shown in Figure 4.2, but reduces flow depth as necessary to keep flow velocity below 10 feet per second. When using this table, compare the design site runoff flow or acreage to the values in the table.

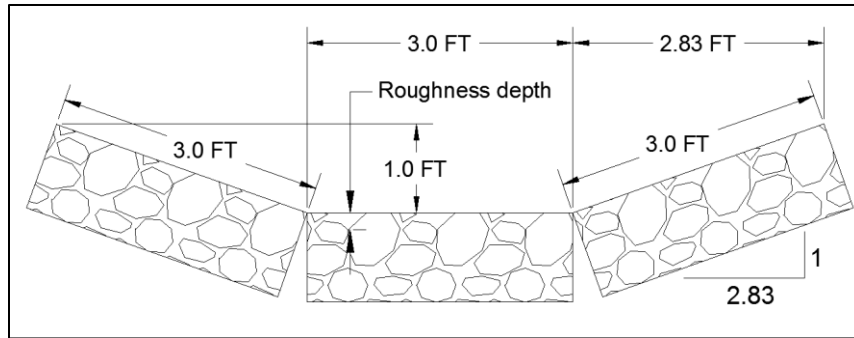

**Figure 4.2 Cross section of riprap/gabion flume.**

**Table 4.7 Stone Flume Carrying Capacity (25% Safety Factor)**

Slope		Maximum Flow (cfs)	Maximum Drainage Area (acres)
5%	20:1	24.7	3.4
10%	10:1	35.0	4.9
20%	5:1	42.2	5.9
33%	3:1	28.3	4.0
40%	5:2	24.6	3.4
50%	2:1	21.1 (gabions only)	2.9 (gabions only)

Note: The allowable flow peaks at 20% slope because at steeper slopes, the maximum permissible velocity is the constraining factor. Also, the maximum drainage area assumes 95% runoff (fully impervious cover). If the drainage area is stable, pervious cover, the maximum drainage area may be increased, but supporting design calculations must accompany the erosion and sediment control plan. (Iowa, 2009; USDA, 1977)

- Maximum slope allowable is 5:2.
- Riprap must have a geotextile underlayment layer, keyed at least 6 inches into existing ground, of Class SD Type I non-woven or PE Type I non-woven fabric. Refer to Table A.1 in Appendix A.
- Riprap flumes must employ outlet stabilization as described in Section 5.1 Rock Outlet Protection or Section 5.2 Plunge Pool/Stilling Basin.
- Remainder of design criteria are presented in Section 4.6 Permanent Channel and Appendix B Open Channel Hydraulics, including derivation of Manning's n value for riprap, based on design flow depth.

### Gabion Flumes

General design constraints and guidance can be found in Section 4.6 Permanent Channel, Appendix B Open Channel Hydraulics, and Section 5.1 Riprap Outlet Protection.

- Flumes must pass 125% of the peak flow expected from a 15-year frequency storm. See Table 4.7.

2. Maximum slope allowed is 2:1.
3. Gabion baskets or mattresses must have a geotextile underlayment layer, keyed at least 6 inches into existing ground, of Class SD Type I non-woven or PE Type I non-woven fabric. Refer to Table A.1 in Appendix A.
4. Fill gabion mattresses with Class 0 riprap or equivalent. Gabion baskets may use larger stone, but the shortest dimension of the basket must be at least 1.5 times the largest stone diameter (cross dimension for angular stone).
5. Gabion flumes must employ outlet stabilization as described in Section 5.1 Rock Outlet Protection or Section 5.2 Plunge Pool/Stilling Basin.
6. Remainder of design criteria are presented in Section 4.6 Permanent Channel and Appendix B Open Channel Hydraulics, including derivation of Manning’s n value for riprap, based on design flow depth.

Paved Flumes

*Capacity*

Flumes must pass 125% of the peak flow expected from a 15-year frequency storm. The standard cross section shown, with 1 foot base width, 1 foot depth, and 1:1 side slopes, has the following maximum flow capacities and associated drainage areas, assuming a Manning’s roughness coefficient of 0.015 (trowel finish) or 0.019 (rough finish), and flowing at maximum depth allowable according to maximum permissible velocity:

**Table 4.8 Concrete Flume Carrying Capacity (25% Safety Factor)**

Slope		Maximum Flow (cfs)		Maximum Drainage Area (acres)	
		Trowel Finish	Rough Finish	Trowel Finish	Rough Finish
		n = 0.015	n = 0.019	n = 0.015	n = 0.019
5%	20:1	23.0	18.2	3.2	2.5
10%	10:1	22.7	23.9	3.1	3.3
20%	5:1	18.7	21.7	2.6	3.0
33%	3:1	15.2	18.7	2.1	2.6
40%	5:2	13.7	17.4	1.9	2.4
50%	2:1	12.0	15.6	1.7	2.1
67%	3:2	9.9	13.4	1.4	1.8

Note: beyond 5% slopes, the maximum permissible velocity is the constraining factor.

### *Cross-Sections*

Detail 405.1 illustrates a typical trapezoidal cross-section of a standard paved flume. Where additional flow capacity is required, larger trapezoidal cross-sections may be designed. The following criteria apply to all trapezoidal flume designs:

1. Longitudinal Slope – The maximum longitudinal slope of the structure must be 3:2 (67%).
2. Curtain Walls – Provide curtain walls at the beginning and end of all paved flumes not abutted to another structure. The curtain wall must be as wide as the flume channel, extend at least 18 inches into the soil below the channel, and have a thickness of 6 inches. Reinforce curtain walls with #4 reinforcing steel bars placed on 6-inch centers.
3. Anchor Lugs – Space anchor lugs at a maximum of 10 feet on center for the length of the flume. Where no curtain wall is required, install an anchor lug within 2 feet of the end of the flume. Anchor lugs are to be as wide as the bottom of the flume channel, extend at least 1 foot into the soil below the channel, and have a thickness of 6 inches. Reinforce anchor lugs with #4 reinforcing steel bars placed on 4-inch centers.
4. Flume Channel – The flume channel must have at least a 4-inch thickness of class A-3 concrete with welded wire fabric (style designation 6×6–W2.1/W2.1) in the center for reinforcement.
5. Expansion Joints – Provide expansion joints approximately every 90 feet. Locate 18-inch dowels of #4 reinforcing steel placed on 5-inch centers at all required joints.

### *Outlet*

Protect outlets of paved flumes from erosion. The use of an energy dissipator with outlet protection (see Chapter 5 Water Control) is recommended to temporarily reduce the existing velocity of the flow, thus preventing undermining of the structure and providing a stable transition zone between the flume and the receiving channel or drainage structure at the base of the slope. Details 405.2 and 405.3 show an energy dissipator, which is designed for use in conjunction with the paved flume. Utilize outlet protection with an energy dissipator structure to further dissipate flow energy and to provide a smooth transition into the receiving channel. Larger energy dissipator systems may be similarly designed for larger flume cross-sections.

## **4.5.5 Construction Specifications**

### Riprap

1. Subgrade elevation must be low enough from the top of the channel lining to accommodate approximately twice the  $d_{50}$  stone depth (the average size of stone).
2. Geotextile must be placed where stone will eventually be placed, and keyed in at least 6 inches at the top of the side slopes of the channel. When more than one section of geotextile is necessary, overlap the sections by at least 1 foot. The geotextile must be pulled taut over the applied surface. Equipment must not run over exposed fabric. When placing riprap on geotextile, do not exceed a 1 foot drop height.
3. Place and compact stone taking care not to damage geotextile underlayment.

### Gabions

1. Set subgrade elevation below the intended channel elevation by the thickness of the gabion baskets or mattresses.
2. Place geotextile where gabions will eventually be placed, and key in at least 6 inches at the top of the side slopes of the channel. When more than one section of geotextile is necessary, overlap the sections by at least 1 foot. The geotextile must be pulled taut over the applied surface. Equipment must not run over exposed fabric.
3. Place gabions, and fill with stone per manufacturer's specifications, or use Class 0 riprap. Gabions are to be bound to each other with wire typically included with the gabion baskets, in order to form a continuous wire structure.

### Concrete

1. Construct the subgrade to the required elevations. Remove and replace all soft sections and unsuitable material with suitable material. Thoroughly compact and shape the subgrade to a smooth, uniform surface. The subgrade must be moist at the time the concrete is poured.
2. Form anchor lugs and curtain walls to be continuous with the channel lining.
3. Provide transverse joints for crack control at approximately 20-foot intervals and when more than 45 minutes elapse between consecutive concrete placements. All sections should be at least 6 feet long. Crack control joints may be formed by using a 1/8-inch thick removable template, by scoring or sawing to a depth of at least 3/4-inch or by an approved "leave-in" type insert.

#### **4.5.6 Maintenance**

Prior to permanent stabilization of the slope, inspect the structure after each rainfall. Immediately repair damages to the slope, flume, or outlet area. After the slope is stabilized, inspect the structure to ensure continued adequate functioning (see potential problems noted in Design Criteria).



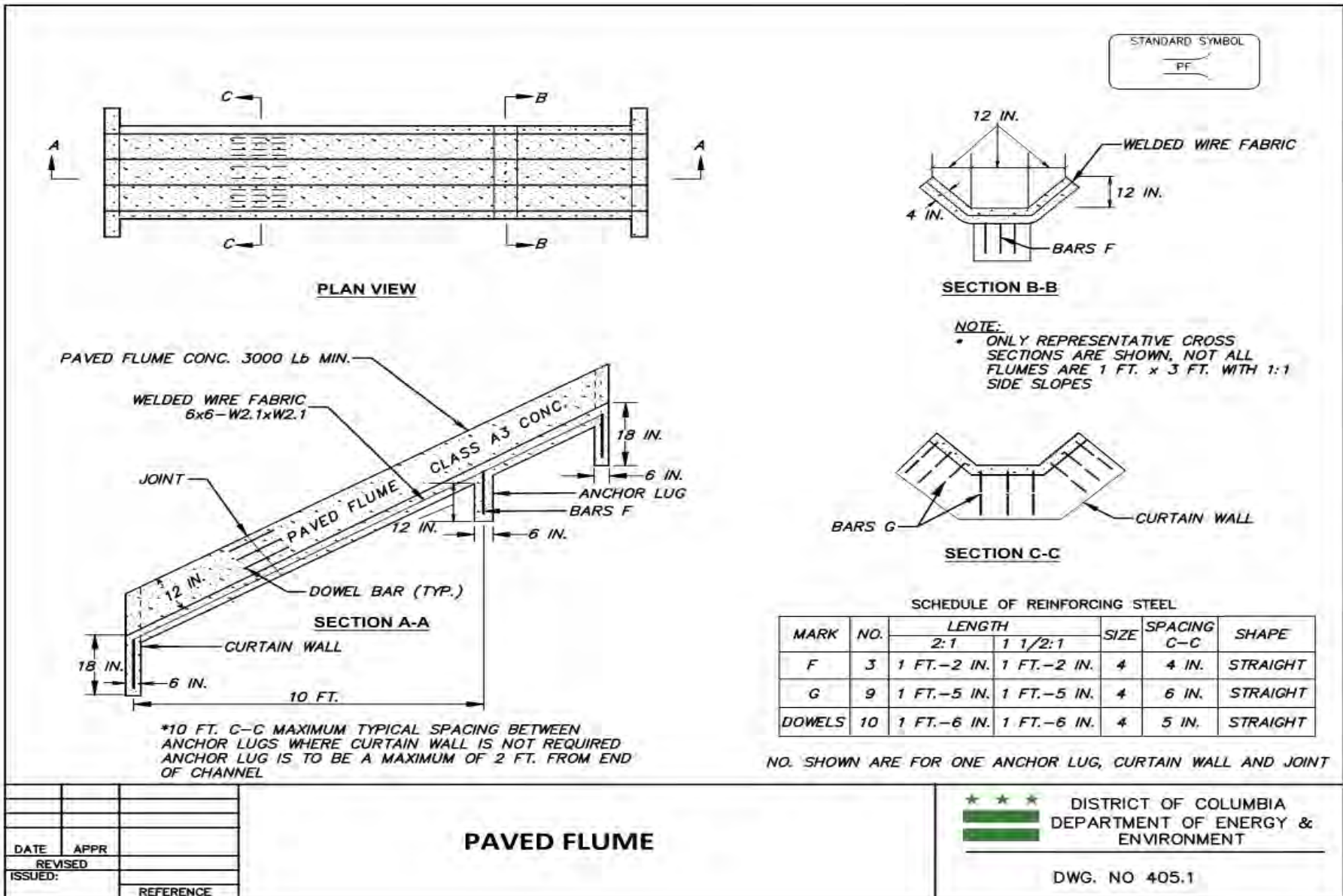

Detail 33 – 405.1 Paved Flume

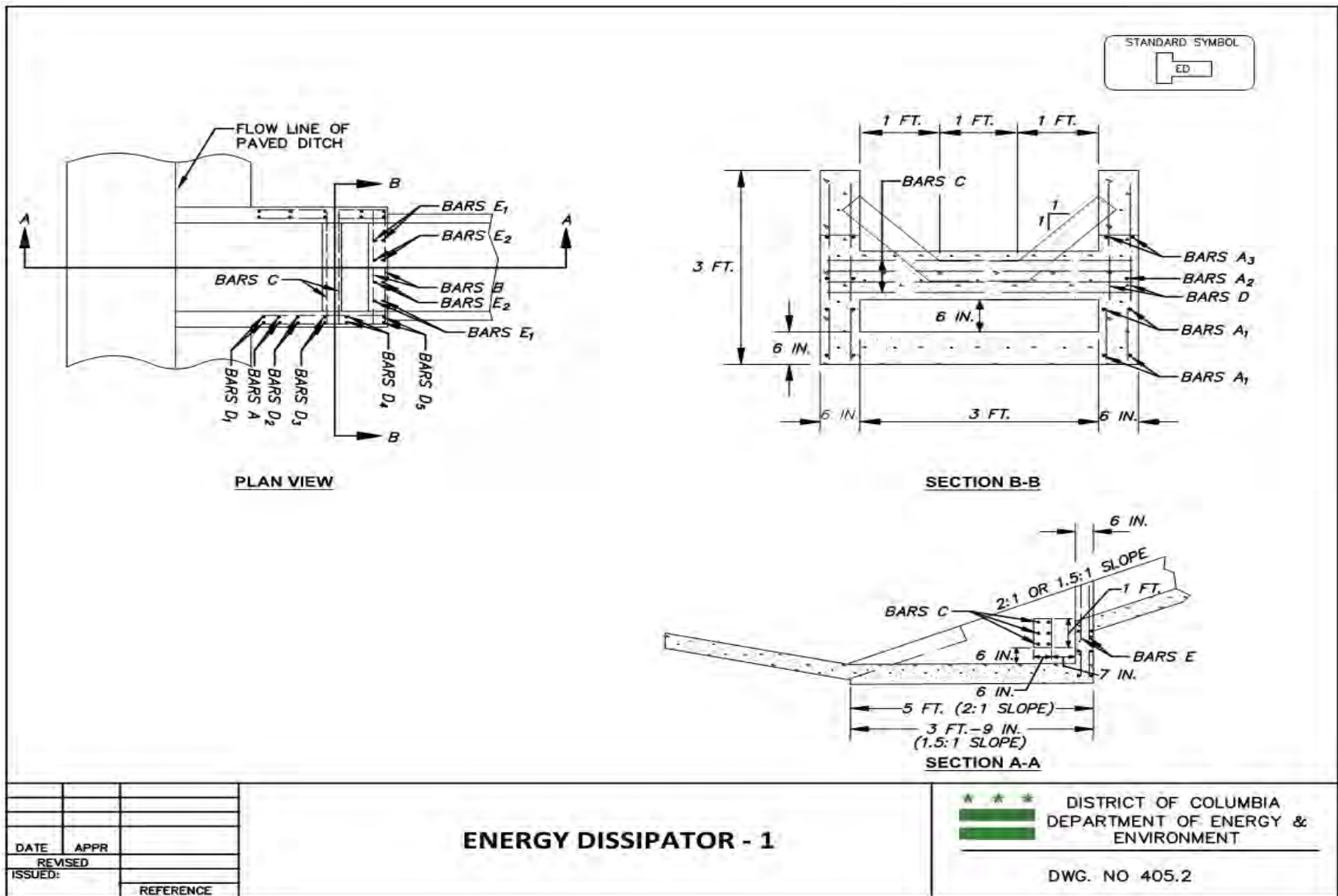

SOURCE: VDOT ROAD AND BRIDGE STANDARDS

Detail 34 – 405.2 Energy Dissipator - 1

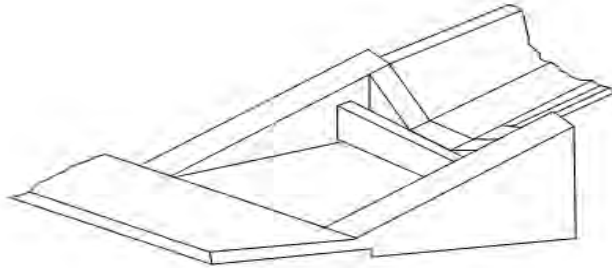
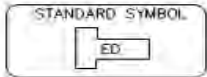

**ISOMETRIC**

APPROXIMATE QUANTITIES			
		CONCRETE	REINFORCING STEEL
		CU. YDS.	LBS.
ENERGY DISSIPATOR	2:1	0.7479	61.20
	1.5:1	0.5921	57.63

**SCHEDULE OF REINFORCING STEEL**

MARK	NO.	LENGTH		SIZE	SPACING C-C	SHAPE
		2:1	1.5:1			
A <sub>1</sub>	8	2 FT.-10 IN.	2 FT.-10 IN.	3	8 IN.	STRAIGHT
A <sub>2</sub>	4	2 FT.-6 1/4 IN.	1 FT.-10 IN.	3	8 IN.	STRAIGHT
A <sub>3</sub>	4	1 FT.-0 3/4 IN.	0 FT.-10 IN.	3	8 IN.	STRAIGHT
B	6	3 FT.-9 IN.	3 FT.-9 IN.	3	8 IN.	STRAIGHT
C	8	3 FT.-8 IN.	3 FT.-8 IN.	3	2-1/2 IN.	STRAIGHT
D <sub>1</sub>	4	1 FT.-2 1/2 IN.	0 FT.-8 IN.	3	8 IN.	STRAIGHT
D <sub>2</sub>	4	1 FT.-6 1/2 IN.	1 FT.-1 1/2 IN.	3	8 IN.	STRAIGHT
D <sub>3</sub>	4	1 FT.-10 1/2 IN.	1 FT.-7 IN.	3	8 IN.	STRAIGHT
D <sub>4</sub>	4	2 FT.-2 1/2 IN.	2 FT.-0 1/2 IN.	3	8 IN.	STRAIGHT
D <sub>5</sub>	4	2 FT.-6 1/2 IN.	2 FT.-6 IN.	3	8 IN.	STRAIGHT
E <sub>1</sub>	4	1 FT.-11 1/2 IN.	1 FT.-11 1/2 IN.	3	8 IN.	STRAIGHT
E <sub>2</sub>	4	1 FT.-5 1/2 IN.	1 FT.-5 1/2 IN.	3	8 IN.	STRAIGHT

DATE	APPR	
REVISED		
ISSUED:		
	REFERENCE	

**ENERGY DISSIPATOR - 2**

★ ★ ★ DISTRICT OF COLUMBIA  
 DEPARTMENT OF ENERGY &  
 ENVIRONMENT

DWG. NO 405.3

SOURCE: VDOT ROAD AND BRIDGE STANDARDS

## **4.6 Permanent Channel**

### **4.6.1 Definition**

An open drainage conveyance lined with vegetation, riprap, gabions, concrete, or other approved material.

### **4.6.2 Purpose**

To convey concentrated runoff in a nonerosive manner.

### **4.6.3 Conditions Where Practice Applies**

A channel is used when permanent conveyance of runoff is necessary. Consider a channel lined with concrete only after all other design options have been deemed infeasible. Soil-water infiltration is an integral part of runoff reduction, and impermeable liners such as concrete or heavily embedded stone eliminate the infiltration potential for a channel. As such, preference for lining material, where conditions allow, is as follows:

1. Turf grass, sod, and grass with stabilization matting, or other vegetation
2. Rock and riprap
3. Gabion or Reno mattress
4. Concrete

### **4.6.4 Design Criteria**

The general design criteria are presented here, but for specific guidance, refer to Appendix B Open Channel Hydraulics. The guidance in Appendix B applies to several specifications.

1. Capacity – The channel must have a minimum capacity ( $Q$ ) to adequately convey the peak rate of runoff from the 15-year, 24-hour storm. Use Table B.1 or Figure B.2 in Appendix B for Manning's coefficient of roughness ( $n$ ).
2. Velocity – Table B.3 in Appendix B shows the maximum allowable design velocity ( $v$ ) for channel lining type. As an alternative to a maximum velocity for a particular material, apply a shear stress (tractive force) constraint for a channel lining. For simplicity, maximum permissible velocity is typically suggested and used.
3. Cross-section – Cross-sections should be triangular, parabolic, or trapezoidal in shape. Monolithic concrete or gabions may be rectangular. Alternative cross sections are rare and must be accompanied by an engineering design. Typical cross sections and geometric parameters are found in Figure B.2 in Appendix B.
4. Freeboard – Extend the lined section up the side slopes to a minimum of 0.25 feet above the design depth. Vegetate or otherwise stabilize the side slopes above the permanent lining and extend a minimum of 0.25 feet above the top of the lining.

5. Side Slopes and Lining Thickness – Steepest permissible side slopes, horizontal to vertical (H:V), and minimum lining thicknesses are given in Table B.2 in Appendix B Open Channel Hydraulics.
6. Related structures – Design side inlets, drop structures, and energy dissipators to meet the hydraulic and structural requirements of the site.
7. Filters or Bedding – Provide filters or bedding to prevent piping, reduce uplift pressure, and collect water as required and in accordance with sound engineering design. Provide weep holes and drains as needed.
8. Concrete –
  - (a) Specify the proportion of concrete to be used for lining so that it is plastic enough for thorough consolidation and stiff enough to stay in place on side slopes. A dense, durable product will be required. A mix that can be certified as suitable to produce a minimum strength of at least 3,000 pounds per square inch is required. Use Portland cement, Type I, II, IV, or V with an aggregate having a maximum diameter of 1½ inches.
  - (b) Provide weep holes in concrete footings and retaining walls to allow free drainage of water. Use non-corrosive pipe for the weep holes.
9. Mortar – Use mortar consisting of a mix of cement, sand, and water with a water-cement ratio of not more than 6 gallons of water per bag of cement for placement of flagstone.
10. Construction Joints – Where required, include form construction joints in concrete linings, transversely to a depth of about one third of the thickness of the lining at a uniform spacing in the range of 10 to 15 feet.
11. Rock Riprap – Provide riprap and gabion stone with a density and hardness to withstand exposure to air, water, freezing, and thawing.
12. Cutoff Walls – Use cutoff walls at the beginning and ending of concrete lining and for rock riprap lining, and key into the channel bottom at both ends of the lining.
13. Gabion Baskets – Fabricate gabions in such a manner that the sides, ends, and lid can be assembled at the site into rectangular baskets of similar size. Install gabion baskets according to the manufacturer specifications.
14. Geotextile – Provide geotextile beneath all riprap and gabions, of Class SD Type I non-woven or PE Type I non-woven fabric.

#### **4.6.5 Construction Specifications**

1. Clear the foundation area of trees, stumps, roots, sod, loose rock, or other objectionable material.
2. Excavate the cross-section to the lines and grades as shown on the plans. Backfill over-excavated areas with moist soil compacted to the density of the surrounding material.
3. Construct the grade or horizontal alignment of the lined channel as per the plans.
4. Place concrete linings to the thickness shown on the plans. Protect freshly placed concrete from freezing or extremely high temperatures to ensure proper curing.

5. Place filter, bedding, and riprap to line and grade in the manner specified.
6. Vegetate all disturbed areas or otherwise protect against soil erosion.

#### **4.6.6 Maintenance**

Maintain the permanent channel line, grade, and cross section as well as the lining to prevent undermining and deterioration. Maintain positive drainage. Remove accumulated sediment and debris. Keep the channel and the point of discharge free of erosion.

## **4.7 Pipe Slope Drain**

### **4.7.1 Definition**

A pipe that is installed to temporarily convey surface runoff down the face of unstabilized slopes.

### **4.7.2 Purpose**

To convey surface runoff down slopes without causing erosion.

### **4.7.3 Conditions Where Practice Applies**

Pipe slope drains (PSD) are used in conjunction with earth dikes. The dikes direct surface runoff to the slope drain, which conveys concentrated flow down the face of a slope. When used to convey water down an unstabilized fill slope on a road construction project the drainage area to the pipe slope drain will be limited to 2 acres. When used as an inflow protection device the drainage area will be limited to 5 acres.

For permanent installations, see Section 4.5 Long Term or Permanent Flumes, Chutes.

### **4.7.4 Design Criteria**

#### Inlet

At the pipe slope drain inlet, the height of the earth dike must be at least two times the pipe diameter and measured from the invert of the pipe. Install and secure a standard flared entrance section at the inlet to the pipe slope drain using a watertight connection. To prevent erosion, place geotextile fabric under the inlet and extend it 5 feet in front of the inlet and key it in 6 inches on all sides.

#### Outlet

When the drainage area is disturbed, outlet the pipe slope drain into a sediment trap or basin, or a stable conveyance that leads to a trap or basin. The point of discharge must be as far away from the trap or basin outlet structure as possible. If it is not possible to discharge to a point far away from the control outlet, silt fence may be used within a sediment trap or basin to create a longer flow path from the PSD discharge to the control structure (see Figure 4.3).

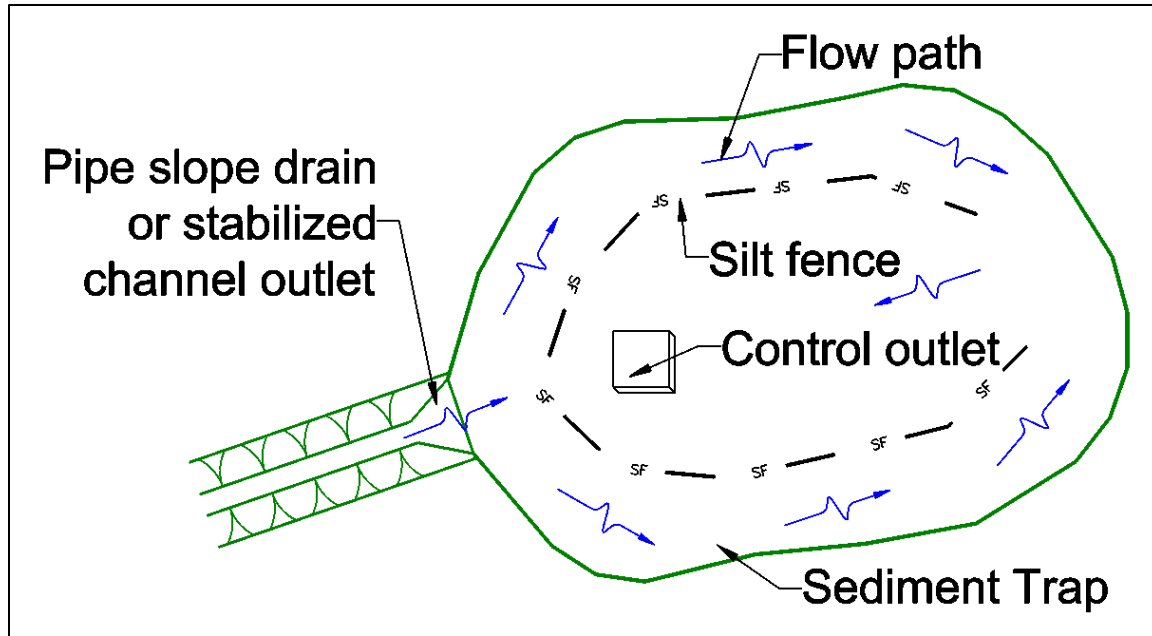

**Figure 4.3 Use of silt fence to increase flow path when discharging to sediment trap.**

When the drainage area is stabilized, outlet the pipe slope drain onto the stabilized area at a nonerosive velocity. The point of discharge may be protected by rock outlet protection.

Slope, Pipe Diameter, Drainage Area

1. The pipe(s) must have the capacity to carry the 15-year peak storm flow with an additional 25% safety factor. See Table 4.9 for sizing guidance.

**Table 4.9 Design Criteria for Pipe Slope Drains**

Size	Diameter (inches)	Maximum Drainage Area (acres)
PSD-12	12	0.4
PSD-18	18	1.2
PSD-21	21	1.8
PSD-24	24	2.5
PSD-24 (2) <sup>1</sup>	24 (× 2)	5.0

<sup>1</sup>Due to the height limitations on earth dikes, the maximum pipe diameter for pipe slope drain is 24 inches. For drainage areas over 2 ½ acres, use two 24-inch pipes. A minimum spacing of 2D (4 feet) is required between pipes.

2. For drainage areas greater than 5 acres, provide supporting storm flow conveyance calculations to demonstrate sufficient capacity.
3. The compacted earth dike must generally follow the specifications as described in Section 4.3 Earth Dikes. The height of the berm covering the top of the pipe slope drain must be



twice the diameter of the pipe measured at the pipe invert, the width of the top of the dike must be at least 6 inches greater than the height of the berm, and the side slopes must be 2:1 or flatter.

4. The PSD must have a slope of 3% or steeper.
5. Flexible tubing is preferred. However, corrugated metal pipe or equivalent PVC pipe can be used.
6. All pipe connections must be watertight.

#### **4.7.5 Construction Specifications**

7. Attach a flared end section to the pipe inlet using a watertight connection. Place geotextile Class E (refer to Appendix A, Table A.1) or better under the pipe slope drain inlet and extend out 5 feet from the inlet. Key in the geotextile fabric on all sides.
8. Securely anchor the pipe slope drain to the slope. Follow manufacturer's specification for anchor spacing. Provide at least 2 anchors, equally spaced along the length of pipe.
9. Hand tamp the soil around and under the pipe and end section in 4-inch lifts to the top of the earth dike.
10. Whenever possible, where a PSD drains an unstabilized area, it must outlet into a sediment trap or basin. If this is not possible then the slope drain must discharge into a stable conveyance that leads to a sediment trap or basin. The PSD must discharge at the same elevation as the wet pool elevation of the trap or basin. The discharge from the PSD must be as far away from the sediment control outlet as possible.
11. When the drainage area is stabilized, discharge the PSD onto a stabilized area at a non-erosive velocity. Employ 4-inch to 7-inch stone underlain with Geotextile Class SE (refer to Appendix A, Table A.1) as necessary. See Section 5.1 Rock Outlet Protection.
12. Perform inspection and any required maintenance periodically and after each rain event.
13. Always keep the inlet open.

#### **4.7.6 Maintenance**

Inspect pipe slope drains weekly and after each runoff event. Remove any accumulated sediment from the inlet. Repair or replace damaged pipe immediately after inspection.

DISCHARGE INTO A STABILIZED CHANNEL, SEDIMENT TRAPPING DEVICE, OR INTO A STABLE AREA AT A NON-EROSIVE VELOCITY (REFERENCE: 5.1 ROCK OUTLET PROTECTION)

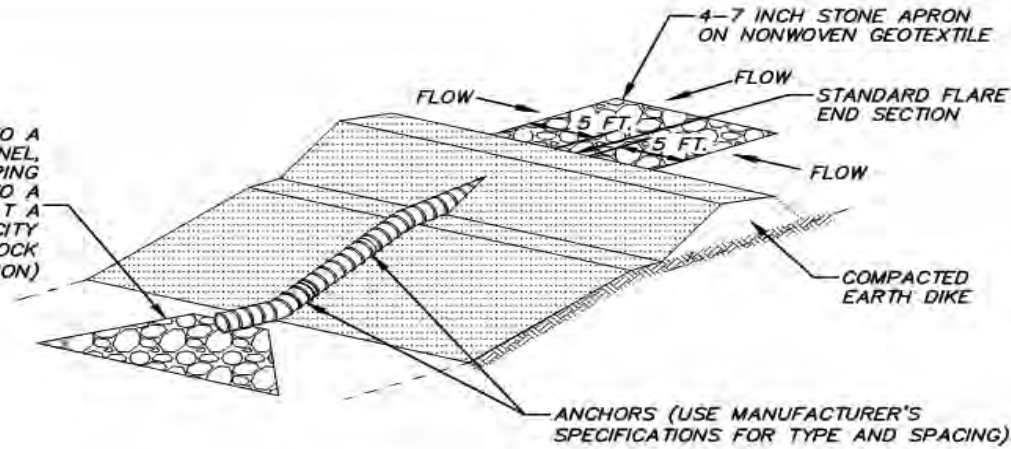

STANDARD SYMBOL  
PSD - 12  
DESIGNATION PSD-12 REFERS TO 12 IN PIPE SLOPE DRAIN.

ISOMETRIC VIEW

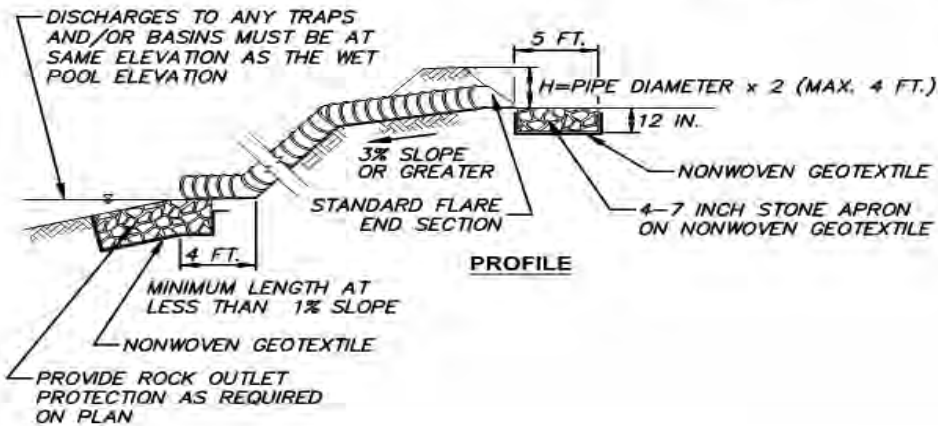

TABLE 4.9 DESIGN CRITERIA FOR PIPE SLOPE DRAIN

SIZE	PIPE/TUBING DIAMETER (D) IN	MAXIMUM DRAINAGE AREA (ACRES)
PSD-12	12	0.4
PSD-18	18	1.2
PSD-21	21	1.8
PSD-24	24	2.5
PSD-24(2)	24(x2)	5.0

DATE	APPR	
REVISED		
ISSUED:		
	REFERENCE	

PIPE SLOPE DRAIN

\*\*\* DISTRICT OF COLUMBIA  
DEPARTMENT OF ENERGY & ENVIRONMENT

DWG. NO 407.1

## **4.8 Temporary Storm Drain Diversion**

### **4.8.1 Definition**

Temporary storm drain diversions redirect a storm sewer system or outfall channel to discharge into a sediment trap or basin.

### **4.8.2 Purpose**

To prevent sediment-laden water conveyed by the storm sewer system from reaching a watercourse or off-site property.

### **4.8.3 Conditions Where Practice Applies**

Use one of the following practices or procedures to temporarily divert storm drain systems. A special exception may be given, at the discretion of DOEE, where site conditions make this procedure impossible.

### **4.8.4 Design Criteria**

1. Construction of a sediment trap or basin below a permanent storm drain outfall – the storm drain system outfalls into a temporary basin or trap constructed below the permanent outfall channel.
1. In-line diversion of storm sewer at an inlet or manhole – this diversion requires installing a pipe stub in the side of a manhole or inlet and temporarily blocking the permanent outfall pipe from that structure. A temporary outfall ditch or pipe may be used to convey storm flow from the stub to a sediment trap or basin. This method may be used just above a permanent outfall or prior to connecting into an existing storm sewer system.
2. Delay completion of the permanent storm drain outfall and temporarily divert storm flow into a sediment basin or trap – an earth dike, swale or designed diversion, can be used depending on the drainage area, to direct flow into a sediment basin or trap.
3. Installation of a stormwater management basin early in the construction sequence – install temporary measures to allow use as a sediment basin. Because these structures are designed to receive storm drain outfalls, diversion should not be necessary.
4. Inlet protection is not required if storm drain diversions have been installed and are functioning properly.
5. A 6-foot fence around the basin is required if it is not protected by a construction site fence.

Refer to the design specifications for the type of diversion and components used.

- Chapter 3 – Sediment Barriers and Filters
- Chapter 4 – Conveyance
- Chapter 5 – Water Control
- Chapter 6 – Sediment Traps and Basins

#### **4.8.5 Construction Criteria**

For initial construction, refer to the construction specifications for the type of diversion and components used.

##### Removal and Restoration

When the areas contributing sediment to the storm sewer system have been stabilized, restore the system to its planned use.

The following removal and restoration procedure is recommended and must be included in the sequence of construction for the sediment control plan:

1. Flush the storm drain system prior to removal of the trap or basin to remove any accumulated sediment.
2. Establish a permanent stabilized outfall channel as noted on the plans.
3. For sites where an inlet was modified, plug the temporary pipe stub and open the permanent outfall pipe.
4. Remove the sediment control devices, such as traps, basins, dikes, swales, etc.
5. Restore the area to grades shown on the plan and stabilize with vegetative measures.
6. For basins that will be converted to stormwater management, remove the accumulated sediment, open the low-flow orifice, and seed all disturbed areas in the basin to permanent vegetation in accordance with Section 2.10 Vegetative Stabilization.

#### **4.8.6 Maintenance**

Refer to the maintenance guidelines for the type of diversion and components used.

- Chapter 3 – Sediment Barriers and Filters
- Chapter 4 – Conveyance
- Chapter 5 – Water Control
- Chapter 6 – Sediment Traps and Basins

---

# Chapter 5 Water Control

## 5.1 Rock Outlet Protection

### 5.1.1 Definition

Rock placed at the outfall of channels or culverts or other points of concentrated discharge.

### 5.1.2 Purpose

To reduce the velocity of the discharge from the outfall to a nonerosive rate.

### 5.1.3 Conditions Where Practice Applies

This practice applies where discharge velocities and energies at the outlets of culverts are sufficient to erode the next downstream reach. This applies to outlets of all types such as sediment basins, stormwater management ponds, and road culverts. Rock outlet protection may be temporary or permanent.

There are three types of standard rock outlet protection (ROP): ROP I, ROP II, and ROP III. Designing suitable outlet protection is based on the geometry of the receiving channel or outlet, size of the outflow pipe, flow rate, flow depth, and tailwater considerations.

### 5.1.4 Design Criteria

The design method presented here applies to sizing rock riprap to protect a downstream area. It does not apply to rock lining of channels or streams. The design of rock outlet protection depends entirely on the location. Pipe outlets at the top of cuts or on slopes steeper than 10% cannot be protected by rock aprons or riprap sections due to reconcentration of flows and high velocities encountered after the flow leaves the apron. Design the rock outlet protection for the same storm as the conveyance discharging to it. For permanent rock outlet protection, the minimum design storm is the 10-year, 24-hour storm.

#### Tailwater Depth

Determine the depth of tailwater immediately below the pipe outlet for the design capacity of the pipe.

1. Minimum Tailwater exists when the depth of the flow in the receiving watercourse, as calculated by Manning's equation, is less than half the diameter of the discharge pipe and the receiving stream is wide enough to accept divergence of the flow, or where the pipe outlets onto flat areas with no defined channel.
2. Maximum Tailwater exists when the depth of flow in the receiving watercourse, as calculated by Manning's equation, is greater than half the diameter of the discharging pipe and the receiving stream will continue to confine the flow.

### Apron Type

Determine the apron type based on the outlet channel conditions.

1. Use Rock Outlet Protection I where the discharge is to a semi-confined area.
2. Use Rock Outlet Protection II where the discharge is to a well-defined channel. Where discharge is perpendicular to the channel, extend the apron across the channel bottom and up the channel banks to an elevation 1 foot above the maximum tailwater depth or to the top of the bank, whichever is less.
3. Use Rock Protection III where the discharge is to a flat area.

Note: Where no endwall is used, construct the upstream end of the apron so that the width is twice the diameter of the outlet pipe, and extend the stone under the outlet by a minimum of 18 inches. Where an end section is used, the upstream end of the apron must conform to the end section.

### Apron Size

Determine the apron length and width from the curves according to the tailwater (Tw) condition:

1. Minimum Tailwater – Use Figure 5.1
2. Maximum Tailwater – Use Figure 5.2

### Bottom Grade

Construct the outlet protection apron with no slope along its length. There must be no overfall at the end of the apron. The elevation of the downstream end of the apron must be equal to the elevation of the receiving channel or adjacent ground.

### Alignment

The outlet protection apron must be straight throughout its entire length.

### Materials

The outlet protection may be done using rock riprap. Riprap must be composed of a well-graded mixture of stone sized so that 50% of the pieces, by weight, must be larger than the size determined by using the charts. The minimum  $d_{50}$  size to be used must be 9 inches. A well-graded mixture as used herein is defined as a mixture composed primarily of larger stone sizes but with a sufficient mixture of other sizes to fill the smaller voids between the stones. The diameter of the largest stone in such a mixture must not exceed the respective  $d_{100}$  selected from Table 5.1.

### Thickness

For riprap specifications, the following values are used:

**Table 5.1 Riprap Sizes and Thicknesses**

<b>Class</b>	<b>d<sub>50</sub> (inches)</b>	<b>d<sub>100</sub> (inches)</b>	<b>Thickness, T (inches)</b>
I	9.5	15	19
II	16	24	32
III	23	34	46

DESIGN OF OUTLET PROTECTION  
 MINIMUM TAILWATER CONDITION ( $T_w < 0.5 \text{ diam.}$ )

For full flow, use  $d$ =pipe diameter and discharge ( $Q$ ) to determine riprap size and apron length.

For partial flow or open channels, use  $d$ =flow depth and velocity ( $V$ ) to determine riprap size and apron length.

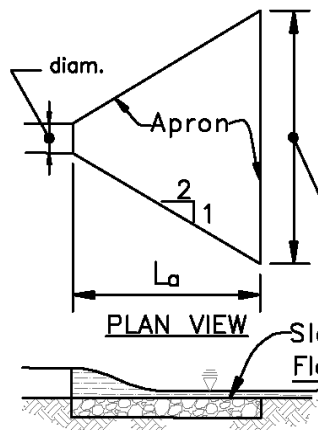

$W = \text{diam.} + L_a$   
 Minimum Length of Apron,  $L_a$ , feet

NOTE: DO NOT  
 EXTRAPOLATE  
 LENGTH OF  
 CURVES.

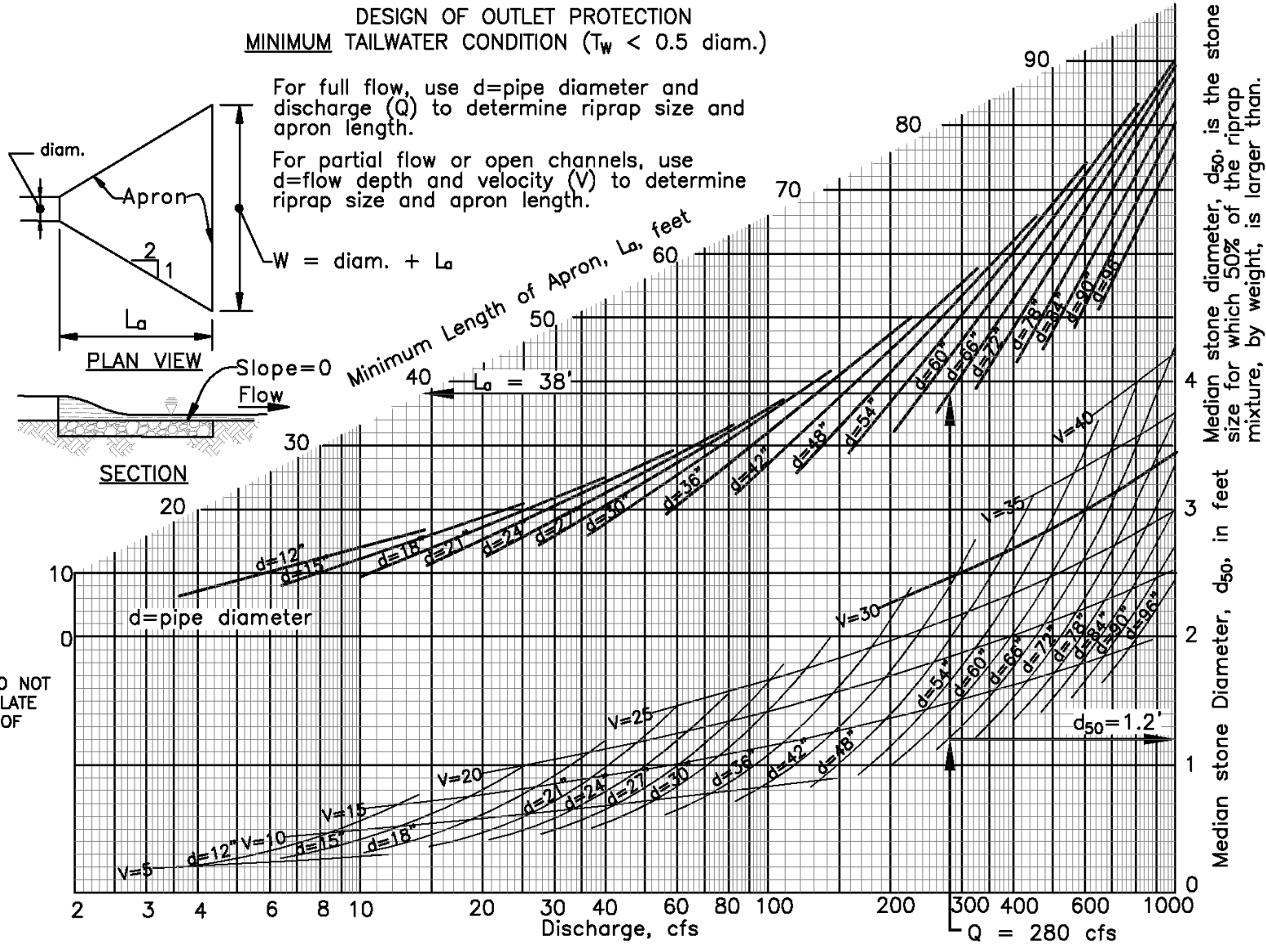

Figure 5.1 Design of outlet protection – minimum tailwater condition.



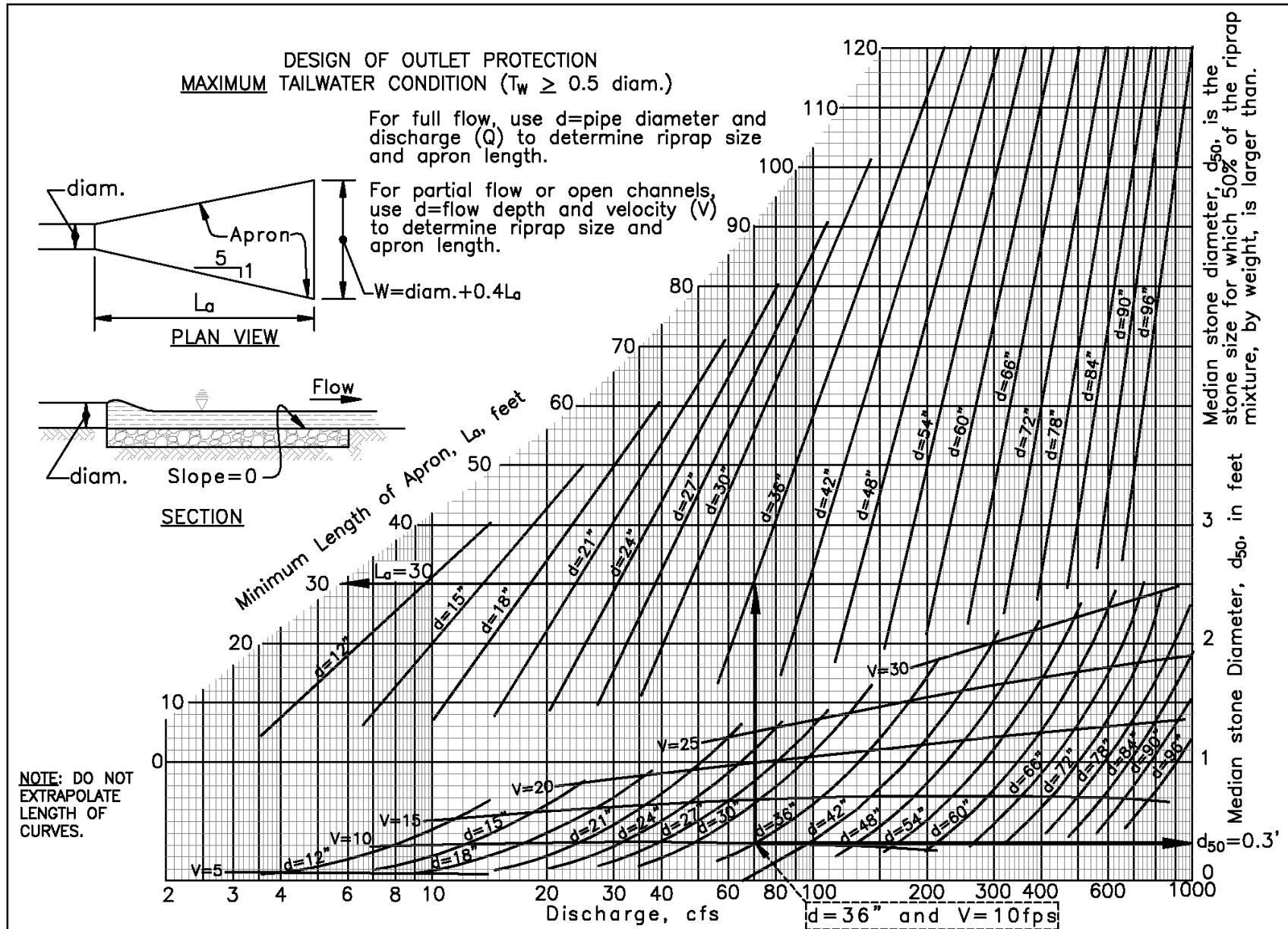

Figure 5.2 Design of outlet protection – maximum tailwater condition.

### Stone Quality

Stone for riprap must consist of field stone or rough and hewn quarry stone. The stone must be hard, angular, and highly resistant to weathering. The specific gravity of the individual stones must be at least 2.5. Recycled concrete equivalent (see Section 2.4 Construction Debris Ground Cover) may be used provided it has a density of at least 150 pounds per cubic foot and does not have any exposed steel or reinforcing bars.

### Filter

A filter is a layer of material placed between the riprap and the underlying soil surface to prevent soil movement into and through the riprap by preventing piping, reducing uplift pressure, and collecting water. Riprap must have a filter placed under it in all cases. A filter can be of two general forms: a gravel layer ( $\frac{3}{8}$ -inch to  $1\frac{1}{2}$ -inch minimum stone, 6 inches deep) or Geotextile Class SE.

### Plans

The plan must include all the information necessary to properly construct the designed rock outlet protection. At a minimum, the following information must be provided on the plan for each rock outlet protection:

1. Type (ROP I, II, or III)
2. Riprap size (Class I, II, or III)
3. Width, W; length La; thickness, T
4. Minimum height of riprap, H

### Design Procedure

1. Investigate the downstream channel to ensure that non-erosive velocities can be maintained.
2. Determine the rock outlet protection type (ROP I, II, or III) based on the discharge channel conditions.
3. Determine the tailwater condition at the outlet to establish which curve to use.
4. Using the appropriate chart, find the pipe diameter (d) and discharge rate (Q) or the depth of flow (D) and discharge velocity (v) to determine the riprap size ( $d_{50}$ ) and apron length required (La). References to pipe diameters in the charts are based on full flow. For other than full pipe flow, the parameters of depth of flow and velocity must be used. Interpolate between curves for velocities and depths not shown on chart. Do not extrapolate length of curves.
5. Calculate apron width (W) at the downstream end if a flared section is to be employed.  
For minimum tailwater:  $W \geq \text{diameter} + La$   
For maximum tailwater:  $W \geq \text{diameter} + 0.4 La$
6. Determine the height of riprap. The riprap at the sides of the apron needs to extend up to a height (H) equal to the maximum depth of flow. For ROP I under maximum tailwater conditions, the maximum depth of flow is the pipe diameter or the tailwater depth, whichever

is greater. For ROP II under maximum tailwater conditions, the maximum depth of flow equals the downstream normal depth or the discharge depth, whichever is greater. For minimum tailwater conditions,  $H$  equals the discharge depth or  $D/2$ , whichever is greater.

**Example 1:** *Pipe Flow (Full) with Discharge to Unconfined Section*

Given:  $Q = 280$  cfs, diameter ( $d$ ) = 66 inches, tailwater ( $T_w$ ) is 2 feet above pipe invert

Find: The required length, width, median stone size ( $d_{50}$ ), and thickness for a riprap lined apron.

Solution:

1. Because the outfall is unconfined, use Rock Outlet Protection III.
2.  $T_w < 1/2 d$ , therefore minimum tailwater condition controls.
3. Using Figure 5.1 for  $Q = 280$  cfs and  $d = 66$  inches,
  - (a) Read  $d_{50} = 1.2$  feet (14 inches).
  - (b) Then moving up to the  $d = 66$  inches curve above, read apron length,  $L_a = 38$  feet.
4. Since  $d_{50} = 14$  inches, use Class II Riprap ( $d_{50} = 16$  inches).
5. Apron width,  $W = \text{diameter} + L_a = 5.5 \text{ feet} + 38 \text{ feet} = 43.5 \text{ feet}$

Include on the plan:

- ROP III
- Class II riprap
- $L_a = 38$  feet
- $W = 43.5$  feet
- $T = 32$  inches
- Minimum height of riprap,  $H = 2.75$  feet

**Example 2:** *Box Flow (Partial) with High Tailwater*

Given: A concrete box 5.5 feet by 10 feet is flowing 5 feet deep;  $Q = 600$  cfs, and tailwater (surface) is 5 feet above invert

Find: The required length, width, median stone size ( $d_{50}$ ), and thickness for a riprap lined apron.

Solution:

1. Because the channel is well defined, use Rock Outlet Protection II.
2.  $T_w > 1/2 d$ , therefore maximum tailwater condition controls.

3.  $V = Q/A = 600 \text{ cfs}/(5 \text{ feet by } 10 \text{ feet}) = 12 \text{ fps}$
4. Using Figure 5.2, at the intersection of the curve for  $d = 60$  inches and the interpolated curve for  $v = 12$  fps,
  - (a) Read  $d_{50} = 0.4$  feet.
  - (b) Then moving to the  $d = 60$  inches curve, read apron length,  $L_a = 40$  feet.
5. Since  $d_{50} = 4.8$  inches, use Class I riprap ( $d_{50} = 9.5$  inches).
6. Apron width,  $W = \text{conduit width} + 0.04 L_a = 10 \text{ feet} + (0.4)(40 \text{ feet}) = 26 \text{ feet}$ .

Include on the plan:

- ROP II
- Class I riprap
- $L_a = 40$  feet
- $W = 26$  feet
- $T = 19$  inches
- Minimum height of riprap,  $H = 5$  feet

**Example 3:** Open Channel Flow with Discharge to Unconfined Section

**Given:** A trapezoidal concrete channel 5 feet wide with 2:1 side slopes is flowing 2 feet deep;  $Q = 180$  cfs (velocity = 10 fps); and the tailwater (surface) downstream is 0.8-foot

**Find:** The required length, width, median stone size ( $d_{50}$ ), and thickness for a riprap lined apron.

**Solution:**

1. Because the outlet is unconfined, use Rock Outlet Protection III.
2.  $T_w < 1/2 d$  channel flow depth, therefore minimum tailwater condition controls.
3. Using Figure 5.1, at the intersection of the curve,  $d = 24$  inches and  $v = 10$  fps,
  - (a) Read  $d_{50} = 0.7$  feet. Since  $d_{50} = 9$  inches, use  $d_{50} = 9.5$  inches.
  - (b) Then moving to the  $d = 24$ -inch curve, read apron length ( $L_a$ ) = 22 feet.
4. Apron width,  $W = \text{bottom of width of channel} + L_a = 5 \text{ feet} + 22 \text{ feet} = 27 \text{ feet}$ .

Include on the plan:

- ROP III
- Class I riprap
- $L_a = 22$  ft

- $W = 27$  ft
- $T = 19$  in
- Minimum height of riprap,  $H = 2$  ft

**Example 4:** Pipe Flow (Partial) with Discharge to a Confined Section

**Given:** A 48-inch pipe is discharging with a depth of 3 feet,  $Q = 100$  cfs, and a discharge velocity of 10 fps (established from partial flow analysis) to a confined trapezoidal channel with a 2-foot bottom, 2:1 side slopes,  $n = 0.04$ , and a grade of 0.6%; the discharge enters the channel perpendicularly.

**Find:** The required length, width, median stone size ( $d_{50}$ ), and thickness for a riprap lined apron.

**Solution:**

1. Because the receiving channel is confined, use Rock Outlet Protection II.
2. Calculations for the downstream channel (Manning's Equation) indicates a normal depth of 3.1 feet and a normal velocity of 3.0 fps.
3.  $T_w > 1/2 d$ , therefore maximum tailwater condition controls.
4. Using Figure 5.2, at the intersection of the curve,  $d = 36$  inches and  $v = 10$  fps,
  - (a) Read  $d_{50} = 0.3$  feet.
  - (b) Then moving up to the  $d = 36$ -inch curve, read apron length,  $L_a = 30$  feet.
5. Since  $d_{50} = 3.6$  inches, use Class I riprap ( $d_{50} = 9.5$  inches).
6. Apron width,  $W = \text{pipe diameter} + 0.4 L_a = 4 \text{ feet} + (0.4)(30 \text{ feet}) = 16 \text{ feet}$
7. Since the maximum flow depth in this reach is 3.1 feet and the discharge is perpendicular to the channel, then the minimum depth of the riprap must be 4.1 feet (3.1 feet + 1 foot of freeboard). The apron needs to be extended across the channel bottom and up the channel banks to 4.1 feet.

Include on the plan:

- ROP II
- Class I riprap
- $L_a = 30$  feet
- $W = 16$  feet
- $T = 19$  inches
- Minimum height of riprap,  $H = 4.1$  feet

### **5.1.5 Construction Specifications**

1. Prepare the subgrade for the riprap to the required lines and grades. Compact any fill required in the subgrade to a density of approximately that of the surrounding undisturbed material.
2. Conform the rock or gravel to the specified grading limits when installed in the riprap.
3. Use filter stone or nonwoven geotextile as specified and protect from punching, cutting, or tearing. Repair any damage other than an occasional small hole by placing another piece of geotextile fabric over the damaged part or by completely replacing the geotextile fabric. All overlaps whether for repairs or for joining two pieces of geotextile fabric must be a minimum of 1 foot. Extend geotextile at least 6 inches beyond edges of riprap and embed at least 4 inches at sides of the riprap.
4. Stone for the riprap outlets may be placed by equipment. Construct the outlets to the full course thickness in one operation and in such a manner as to avoid displacement of underlying materials. Deliver and place the riprap in a manner that will ensure that it is reasonably homogenous with the smaller stones and spalls filling the voids between the larger stones. Place riprap in a manner that prevents damage to the filter blanket or geotextile fabric. Hand placement will be required to the extent necessary to prevent damage to the permanent works.
5. Place the stone so that it blends in with the existing ground. If the stone is placed too high, then the flow will be forced out of the channel and scour adjacent to the stone will occur.

### **5.1.6 Maintenance**

Once a riprap outlet has been installed, the maintenance needs are very low. Maintain the line, grade, and cross section and keep the outlet free of erosion. Inspect the outlet after high flows to see if scour beneath the riprap has occurred or if any stones have been dislodged. Make repairs immediately. Remove accumulated sediment and debris.

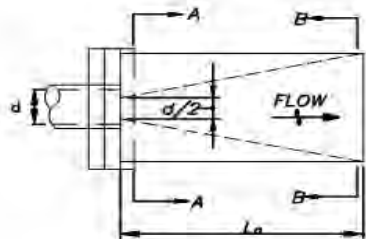

PLAN VIEW

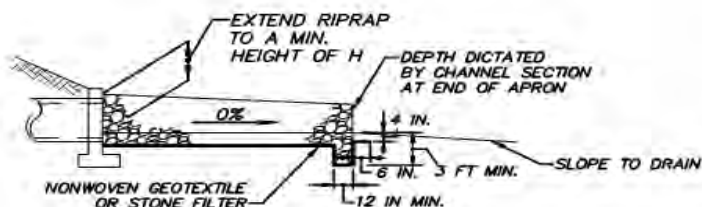

PROFILE



SECTION A-A

CHANNEL CROSS SECTION WILL TRANSITION FROM A-A TO B-B

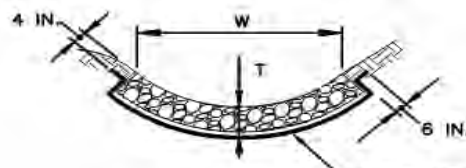

SECTION B-B

NONWOVEN GEOTEXTILE OR STONE FILTER

STANDARD SYMBOL

DISCHARGE TO SEMI CONFINED CHANNEL SECTION

NOTE:  
 • VARIABLE DEFINITIONS CAN BE FOUND IN CHAPTER 5.1—ROCK OUTLET PROTECTION

RIPRAP	
CLASS	THICKNESS (T)
I	19 IN.
II	32 IN.
III	46 IN.

**CONSTRUCTION SPECIFICATIONS**

1. PREPARE THE SUBGRADE FOR THE RIPRAP TO THE REQUIRED LINES AND GRADES. COMPACT ANY FILL REQUIRED IN THE SUBGRADE TO A DENSITY OF APPROXIMATELY THAT OF THE SURROUNDING UNDISTURBED MATERIAL.
2. CONFORM THE ROCK OR GRAVEL TO THE SPECIFIED GRADING LIMITS WHEN INSTALLED IN THE RIPRAP.
3. USE FILTER STONE OR NONWOVEN GEOTEXTILE AS SPECIFIED AND PROTECT FROM PUNCHING, CUTTING, OR TEARING. REPAIR ANY DAMAGE OTHER THAN AN OCCASIONAL SMALL HOLE BY PLACING ANOTHER PIECE OF GEOTEXTILE FABRIC OVER THE DAMAGED PART OR BY COMPLETELY REPLACING THE GEOTEXTILE FABRIC. ALL OVERLAPS WHETHER FOR REPAIRS OR FOR JOINING TWO PIECES OF GEOTEXTILE FABRIC MUST BE A MINIMUM OF 1 FOOT. EXTEND GEOTEXTILE AT LEAST 6 INCHES BEYOND EDGES OF RIPRAP AND EMBED AT LEAST 4 INCHES AT SIDES OF RIPRAP.
4. STONE FOR THE RIPRAP OUTLETS MAY BE PLACED BY EQUIPMENT. CONSTRUCT THE OUTLETS TO THE FULL COURSE THICKNESS IN ONE OPERATION AND IN SUCH A MANNER AS TO AVOID DISPLACEMENT OF UNDERLYING MATERIALS. DELIVER AND PLACE THE STONE FOR RIPRAP IN A MANNER THAT WILL ENSURE THAT IT IS REASONABLY HOMOGENOUS WITH THE SMALLER STONES AND SPALLS FILLING THE VOIDS BETWEEN THE LARGER STONES. PLACE RIPRAP IN A MANNER THAT PREVENTS DAMAGE TO THE FILTER BLANKET OR GEOTEXTILE FABRIC. HAND PLACEMENT WILL BE REQUIRED TO THE EXTENT NECESSARY TO PREVENT DAMAGE TO THE PERMANENT WORKS.
5. PLACE THE STONE SO THAT IT BLENDS IN WITH THE EXISTING GROUND. IF THE STONE IS PLACED TOO HIGH THEN FLOW WILL BE FORCED OUT OF THE CHANNEL AND SCOUR ADJACENT TO THE STONE WILL OCCUR.

DATE	APPR
REVISED	
ISSUED:	
	REFERENCE

**ROCK OUTLET PROTECTION - 1**

★ ★ ★ DISTRICT OF COLUMBIA  
 DEPARTMENT OF ENERGY & ENVIRONMENT

DWG. NO 501.1

SOURCE: 2011 MARYLAND STANDARDS AND SPECIFICATIONS



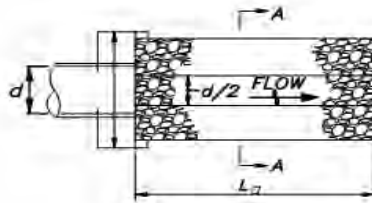

PLAN VIEW

SIDE SLOPES TO TRANSITION FROM 2:1 AT PIPE OUTLET TO THE EXISTING CHANNEL SLOPE AT THE END OF THE APRON

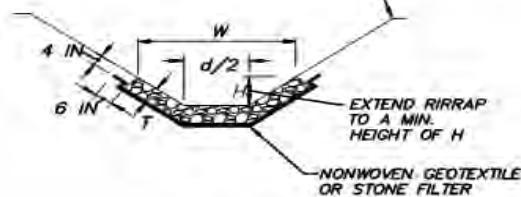

SECTION A-A

STANDARD SYMBOL

DISCHARGE TO CONFINED CHANNEL SECTION

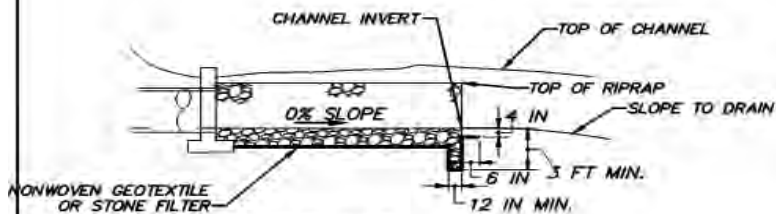

PROFILE

RIPRAP	
CLASS	THICKNESS (T)
I	19 IN.
II	32 IN.
III	46 IN.

**NOTE:**

- VARIABLE DEFINITIONS CAN BE FOUND IN CHAPTER 5.1- ROCK OUTLET PROTECTION

**CONSTRUCTION SPECIFICATIONS**

- PREPARE THE SUBGRADE FOR THE RIPRAP TO THE REQUIRED LINES AND GRADES. COMPACT ANY FILL REQUIRED IN THE SUBGRADE TO A DENSITY OF APPROXIMATELY THAT OF THE SURROUNDING UNDISTURBED MATERIAL.
- CONFORM THE ROCK OR GRAVEL TO THE SPECIFIED GRADING LIMITS WHEN INSTALLED IN THE RIPRAP.
- USE FILTER STONE OR NONWOVEN GEOTEXTILE AS SPECIFIED AND PROTECT FROM PUNCHING, CUTTING, OR TEARING. REPAIR ANY DAMAGE OTHER THAN AN OCCASIONAL SMALL HOLE BY PLACING ANOTHER PIECE OF GEOTEXTILE FABRIC OVER THE DAMAGED PART OR BY COMPLETELY REPLACING THE GEOTEXTILE FABRIC. ALL OVERLAPS WHETHER FOR REPAIRS OR FOR JOINING TWO PIECES OF GEOTEXTILE FABRIC MUST BE A MINIMUM OF 1 FOOT. EXTEND GEOTEXTILE AT LEAST 6 INCHES BEYOND EDGES OF RIPRAP AND EMBED AT LEAST 4 INCHES AT SIDES OF RIPRAP.
- STONE FOR THE RIPRAP OUTLETS MAY BE PLACED BY EQUIPMENT. CONSTRUCT THE OUTLETS TO THE FULL COURSE THICKNESS IN ONE OPERATION AND IN SUCH A MANNER AS TO AVOID DISPLACEMENT OF UNDERLYING MATERIALS. DELIVER AND PLACE THE STONE FOR RIPRAP IN A MANNER THAT WILL ENSURE THAT IT IS REASONABLY HOMOGENOUS WITH THE SMALLER STONES AND SPALLS FILLING THE VOIDS BETWEEN THE LARGER STONES. PLACE RIPRAP IN A MANNER THAT PREVENTS DAMAGE TO THE FILTER BLANKET OR GEOTEXTILE FABRIC. HAND PLACEMENT WILL BE REQUIRED TO THE EXTENT NECESSARY TO PREVENT DAMAGE TO THE PERMANENT WORKS.
- PLACE THE STONE SO THAT IT BLENDS IN WITH THE EXISTING GROUND. IF THE STONE IS PLACED TOO HIGH THEN FLOW WILL BE FORCED OUT OF THE CHANNEL AND SCOUR ADJACENT TO THE STONE WILL OCCUR.

DATE	APPR	
REVISED		
ISSUED:		
	REFERENCE	

**ROCK OUTLET PROTECTION - 2**

\*\*\* DISTRICT OF COLUMBIA DEPARTMENT OF ENERGY & ENVIRONMENT

DWG. NO 501.2

SOURCE: 2011 MARYLAND STANDARDS AND SPECIFICATIONS



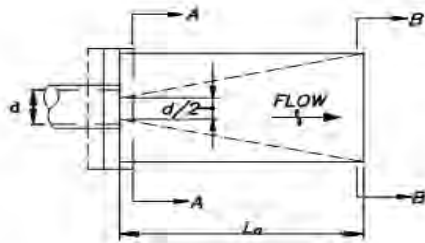

PLAN VIEW

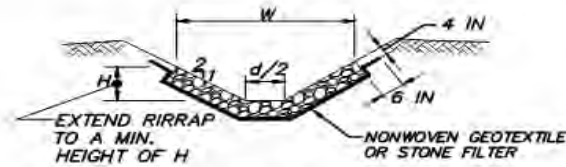

SECTION A-A

STANDARD SYMBOL

DISCHARGE TO AN UNCONFINED CHANNEL OR FLAT AREA

**NOTE:**  
 • VARIABLE DEFINITIONS CAN BE FOUND IN CHAPTER 5.1- ROCK OUTLET PROTECTION

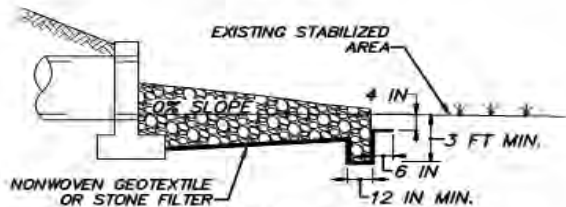

PROFILE

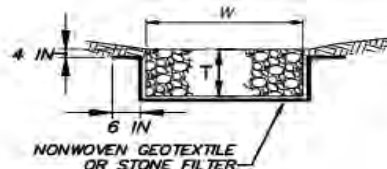

SECTION B-B

RIPRAP	
CLASS	THICKNESS (T)
I	19 IN.
II	32 IN.
III	46 IN.

**CONSTRUCTION SPECIFICATIONS**

1. PREPARE THE SUBGRADE FOR THE RIPRAP TO THE REQUIRED LINES AND GRADES. COMPACT ANY FILL REQUIRED IN THE SUBGRADE TO A DENSITY OF APPROXIMATELY THAT OF THE SURROUNDING UNDISTURBED MATERIAL.
2. CONFORM THE ROCK OR GRAVEL TO THE SPECIFIED GRADING LIMITS WHEN INSTALLED IN THE RIPRAP.
3. USE FILTER STONE OR NONWOVEN GEOTEXTILE AS SPECIFIED AND PROTECT FROM PUNCHING, CUTTING, OR TEARING. REPAIR ANY DAMAGE OTHER THAN AN OCCASIONAL SMALL HOLE BY PLACING ANOTHER PIECE OF GEOTEXTILE FABRIC OVER THE DAMAGED PART OR BY COMPLETELY REPLACING THE GEOTEXTILE FABRIC. ALL OVERLAPS WHETHER FOR REPAIRS OR FOR JOINING TWO PIECES OF GEOTEXTILE FABRIC MUST BE A MINIMUM OF 1 FOOT. EXTEND GEOTEXTILE AT LEAST 6 INCHES BEYOND EDGES OF RIPRAP AND EMBED AT LEAST 4 INCHES AT SIDES OF RIPRAP.
4. STONE FOR THE RIPRAP OUTLETS MAY BE PLACED BY EQUIPMENT. CONSTRUCT THE OUTLETS TO THE FULL COURSE THICKNESS IN ONE OPERATION AND IN SUCH A MANNER AS TO AVOID DISPLACEMENT OF UNDERLYING MATERIALS. DELIVER AND PLACE THE STONE FOR RIPRAP IN A MANNER THAT WILL ENSURE THAT IT IS REASONABLY HOMOGENOUS WITH THE SMALLER STONES AND SPALLS FILLING THE VOIDS BETWEEN THE LARGER STONES. PLACE RIPRAP IN A MANNER THAT PREVENTS DAMAGE TO THE FILTER BLANKET OR GEOTEXTILE FABRIC. HAND PLACEMENT WILL BE REQUIRED TO THE EXTENT NECESSARY TO PREVENT DAMAGE TO THE PERMANENT WORKS.
5. PLACE THE STONE SO THAT IT BLENDS IN WITH THE EXISTING GROUND. IF THE STONE IS PLACED TOO HIGH THEN FLOW WILL BE FORCED OUT OF THE CHANNEL AND SCOUR ADJACENT TO THE STONE WILL OCCUR.

DATE	APPR
REVISED	
ISSUED:	
	REFERENCE

**ROCK OUTLET PROTECTION - 3**

★ ★ ★ DISTRICT OF COLUMBIA  
 DEPARTMENT OF ENERGY &  
 ENVIRONMENT

DWG. NO 501.3

SOURCE: 2011 MARYLAND STANDARDS AND SPECIFICATIONS

## **5.2 Plunge Pool/Stilling Basin**

### **5.2.1 Definition**

An excavated depression lined with riprap and placed at the outfall of a culvert and conduit.

### **5.2.2 Purpose**

To dissipate the energy of a discharge and prevent scour at a pipe outfall.

### **5.2.3 Conditions Where Practice Applies**

Where discharge velocity and energy at a pipe outlet is sufficient to erode the downstream channel reach. This applies to the following:

- Culvert outlets of all types.
- Pipe conduits from all sediment basins, dry stormwater ponds, and permanent ponds.
- Situations where there is no defined outlet channel for the culvert or conduit.
- Situations which require a specific design velocity into a receiving channel.

Plunge pools are an alternative to rock outlet protection and are preferable in locations where space constraints exist. Sufficient room is required to construct the pool/basin between the pipe and the receiving watercourse. Generally, the size and amount of riprap required for a stilling basin is often less than would be required for a riprap apron. A plunge pool may be temporary or permanent, based on design.

### **5.2.4 Design Criteria**

1. Select type of plunge pool (larger stone required for Type 1):

Type I: Plunge pool is depressed half the size of the culvert rise.

Type II: Plunge pool is depressed the full height of the culvert rise.

2. Determine the riprap ( $d_{50}$ ) stone size for the plunge pool type and design storm flow.

Type I:

$$d_{50} = \left( \frac{0.0125D^2}{T_w} \right) \times \left( \frac{Q}{D^{2.5}} \right)^{\frac{4}{3}}$$

Type II:

$$d_{50} = \left( \frac{0.0082D^2}{T_w} \right) \times \left( \frac{Q}{D^{2.5}} \right)^{\frac{4}{3}}$$

Where:

- $d_{50}$  = the median stone size in feet (refer to Table A.2 Stone Size)
- $D$  = the culvert diameter or span in feet
- $T_w$  = the tailwater depth in feet
- $Q$  = the design flow for the culvert, minimum 10-year, 24-hour storm, in cfs  
Use nonwoven geotextile as specified in Appendix A.  
Determine plunge pool dimensions.

3. Use nonwoven geotextile as specified in Appendix A.
4. Determine plunge pool dimensions.

$$C = (3 \times D) + (6 \times F)$$

$$B = (2 \times D) + (6 \times F)$$

Where:

- $C$  = the plunge pool length in feet
  - $B$  = the plunge pool width in feet
  - $D$  = the culvert diameter or span in feet
  - $F$  = plunge pool depth in feet =  $d$  (for Type II) or  $0.5 d$  (for Type I)
  - $T$  =  $2 \times d_{50}$  = riprap thickness in feet
  - $E$  = the culvert diameter or span in feet equal to  $D$
  - $3E$  = the plunge pool bottom length in feet
  - $2E$  = the plunge pool bottom width in feet
5. For permanent uses, provide a toewall at the downstream end at a depth twice the ( $T$ ) dimension and at a width equal to the ( $T$ ) dimension, on nonwoven geotextile. Extend the rip-rap a minimum of 18 inches under the outlet pipe if the outlet does not have a footer or headwall.
6. Provide an underdrain to a suitable outfall if standing water in the plunge pool is an issue or as required by DOEE.

7. Provide the design values on the plans for the following dimensions: B, C, T, E, and F.

### **5.2.5 Construction Specifications**

1. Use specified class of riprap.
2. Use nonwoven geotextile as specified and protect from punching, cutting, or tearing. Repair any damage other than an occasional small hole by placing another piece of geotextile over the damaged part or by completely replacing the geotextile. Provide a minimum of 1 foot overlap for all repairs and for joining 2 pieces of geotextile.
3. Prepare the subgrade for the plunge pool to the required lines and grades. Compact any fill required in the subgrade to a density of approximately that of the surrounding undisturbed material.
4. Embed the geotextile a minimum of 4 inches and extend the geotextile a minimum of 6 inches beyond the edge of the scour hole.
5. Stone for the plunge pool may be placed by equipment. Construct to the full course thickness in one operation and in such a manner as to avoid displacement of underlying materials. Deliver and place the stone for the plunge pool in a manner that will ensure that it is reasonably homogeneous with the smaller stones and spalls filling the voids between the larger stones. Place stone for the plunge pool in manner to prevent damage to the geotextile. Hand place to the extent necessary.
6. At the plunge pool outlet, place the stone so that it meets the existing grade.

### **5.2.6 Maintenance**

Maintenance needs are generally low for plunge pools. Maintain the line, grade, and cross section and keep the outlet free of erosion. After high flows inspect for scour and dislodged riprap. Make repairs immediately. Remove accumulated sediment and debris.



## 5.3 Level Spreader

### 5.3.1 Definition

A non-erosive outlet for concentrated runoff constructed to disperse flow uniformly across a slope as sheet flow.

### 5.3.2 Purpose

To convert concentrated flow to sheet flow and release it uniformly over a stabilized area.

### 5.3.3 Conditions Where Practice Applies

- Where sediment-free stormwater runoff can be released in sheet flow down a stabilized slope without causing erosion.
- Where a level lip can be constructed without filling.
- Where the area below the spreader lip is uniform with the slope of 10% or less and is stable for anticipated flow conditions, preferably well-vegetated.
- Where the runoff water will not reconcentrate after release.
- Where there will be no traffic over the spreader.

### 5.3.4 Design Criteria

#### Capacity

Determine the capacity of the spreader by estimating peak flow from the 10-year storm. Restrict the drainage area so that maximum flows into the spreader will not exceed 30 cubic feet per second.

#### Spreader Dimensions

When water enters the spreader from one end, as from a diversion, select the appropriate length, width, and depth of the spreader from Table 5.2.

Construct a 20-foot transition section in the diversion channel so the width of the diversion will smoothly meet the width of the spreader to ensure uniform outflow.

**Table 5.2 Minimum Dimension for Level Spreader**

<b>Design Flow (cfs)</b>	<b>Entrance Width (feet)</b>	<b>Depth (feet)</b>	<b>End Width (feet)</b>	<b>Length (feet)</b>
0–10	10	0.5	3	10
10–20	16	0.6	3	20
20–30	24	0.7	3	30

### Grade

The grade of the last 20 feet of the diversion channel should provide a smooth transition from channel grade to level at the spreader. The grade of the spreader should be 0%.

### Spreader Lip

Construct the level lip on undisturbed soil to uniform height and zero grade over the length of the spreader. Protect it with an erosion resistant material, such as fiberglass matting, to prevent erosion and allow vegetation to become established.

### Outlet Area

The outlet disposal area must be generally smooth and well vegetated with a maximum slope of 10%. Vegetate all disturbed areas.

## **5.3.5 Construction Specifications**

1. The matting should be a minimum of 4 feet wide extending 6 inches over the lip and buried 6 inches deep in a vertical trench on the lower edge. The upper edge should butt against smooth cut sod and be securely held in place with closely spaced heavy duty wire staples at least 12 inches long.
2. Ensure that the spreader lip is level for uniform spreading of stormwater runoff.
3. Construct the level spreader on undisturbed soil (not on fill).
4. Construct a 20-foot transition section from the diversion channel to blend smoothly to the width and depth of the spreader.
5. Disperse runoff from the spreader across a properly stabilized slope not to exceed 10%. Make sure the slope is sufficiently smooth to keep flow from concentrating.
6. Immediately after its construction, appropriately seed and mulch the entire disturbed area of the spreader.

## **5.3.6 Maintenance**

Inspect level spreaders after every rainfall until vegetation is established, and promptly make needed repairs. After the area has been stabilized, make periodic inspections, and keep vegetation in a healthy, vigorous condition.



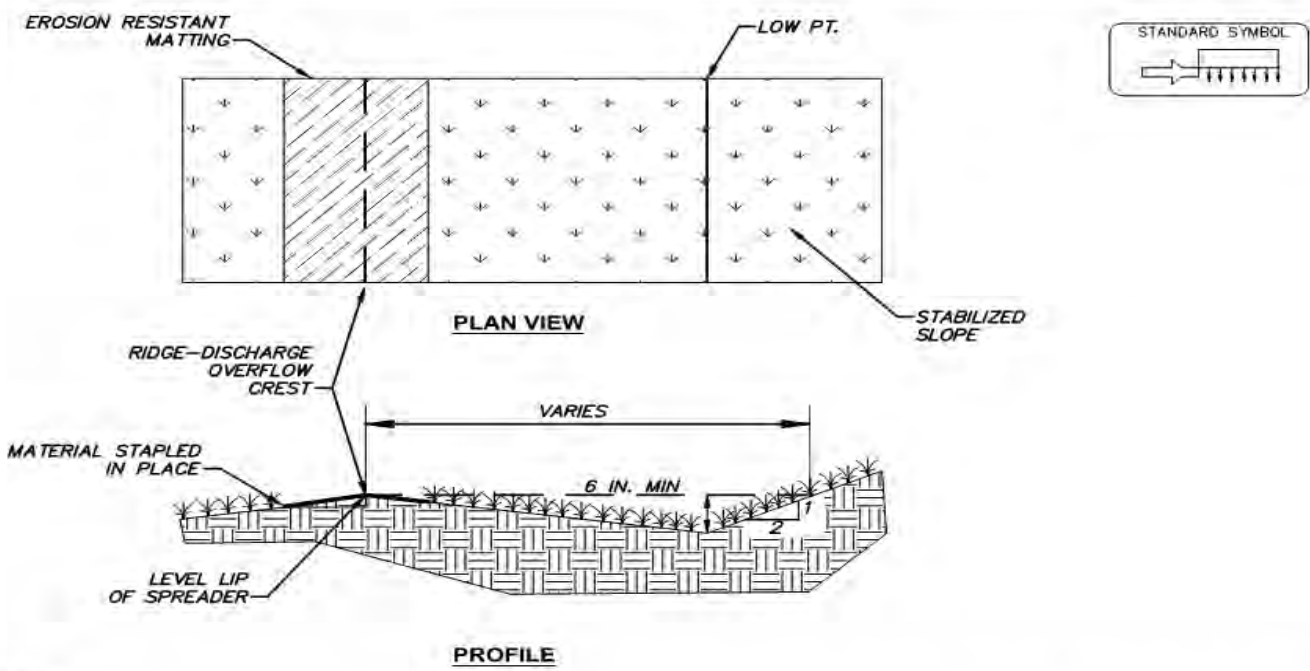

**CONSTRUCTION SPECIFICATIONS**

1. THE MATTING SHOULD BE A MINIMUM OF 4 FT WIDE EXTENDING 6 INCHES OVER THE LIP AND BURIED 6 INCHES DEEP IN A VERTICAL TRENCH ON THE LOWER EDGE. THE UPPER EDGE SHOULD BUTT AGAINST SMOOTH CUT SOD AND BE SECURELY HELD IN PLACE WITH CLOSELY SPACED HEAVY DUTY WIRE STAPLES AT LEAST 12 INCHES LONG.
2. ENSURE THAT THE SPREADER LIP IS LEVEL FOR UNIFORM SPREADING OF STORM RUNOFF.
3. CONSTRUCT THE LEVEL SPREADER ON UNDISTURBED SOIL (NOT ON FILL).
4. CONSTRUCT A 20 FT TRANSITION SECTION FROM THE DIVERSION CHANNEL TO BLEND SMOOTHLY TO THE WIDTH AND DEPTH OF THE SPREADER.
5. DISPERSE RUNOFF FROM THE SPREADER ACROSS A PROPERLY STABILIZED SLOPE NOT TO EXCEED 10%. MAKE SURE THE SLOPE IS SUFFICIENTLY SMOOTH TO KEEP FLOW FROM CONCENTRATING.
6. IMMEDIATELY AFTER ITS CONSTRUCTION, APPROPRIATELY SEED AND MULCH THE ENTIRE DISTURBED AREA OF THE SPREADER.

DATE	APPR	
REVISED		
ISSUED:		
	REFERENCE	

**LEVEL SPREADER**

DISTRICT OF COLUMBIA  
 DEPARTMENT OF ENERGY &  
 ENVIRONMENT  
 DWG. NO 503.1

SOURCE: VA DCR STORMWATER MANAGEMENT HANDBOOK

Detail 41 – 503.1 Level Spreader



## Chapter 6 Sediment Traps and Basins

### 6.1 Sediment Traps

#### 6.1.1 Definition

A temporary sediment control device formed by excavation and/or an embankment with an approved outlet used to intercept sediment-laden runoff and to retain the sediment.

#### 6.1.2 Purpose

To intercept sediment-laden runoff and trap the sediment in order to protect downstream drainage ways, properties, and rights-of-way from sedimentation.

#### 6.1.3 Conditions Where Practice Applies

Install a sediment trap at points of discharge from a disturbed area, including at the outlets of diversions, channels, slope drains, or other runoff conveyances that discharge sediment-laden water.

Do not locate sediment traps in an intermittent or perennial stream.

#### 6.1.4 Design Criteria

If any of the design criteria presented here cannot be met, see Section 6.2 Sediment Basins.

1. Drainage Area – The maximum drainage area is 3 acres.
2. Location – Select locations for sediment traps during site evaluation. Note natural drainage divides and select trap sites so that runoff from potential sediment-producing areas can easily be conveyed to the traps. Because well-planned sediment traps are key measures for preventing off-site sedimentation, install them in the first stages of project development, before the site clearing phase begins.

Make traps readily accessible for periodic sediment removal and other necessary maintenance. Plan locations for sediment disposal as part of trap site selection. Clearly designate all disposal areas on the plans.

3. Emergency Bypass – Locate emergency bypass outlets so that flow will not damage the embankment. Direct emergency bypasses to undisturbed natural, stable areas. If a bypass is not possible and failure would have severe consequences, consider alternative sites.
4. Trap Size – The storage requirement for sediment traps is 3,600 cubic feet per acre of contributory drainage area. Divide this volume equally into "dry" or dewatered storage and "wet" or retention storage. The traps will be dewatered to the wet pool elevation corresponding to 1,800 cubic feet of storage per acre of drainage.

Provide a length to width ratio of 2:1 or greater. If a length to width ratio of 2:1 cannot be provided, baffles must be used (see detail 602.1). See Table 6.1 for sediment trap example sizing.

**Table 6.1 Example Sediment Trap Sizing**

Drainage Area (ac)	Total Volume (ft <sup>3</sup> )	Wet Volume (ft <sup>3</sup> )	Dry Volume (ft <sup>3</sup> )	Minimum Depth (ft)	Depth of Permanent Pool (ft)	Minimum Bottom Length (ft)	Minimum Bottom Width (ft)
1	3,600	1,800	1,800	2.5	1.5	46	23
2	7,200	3,600	3,600	2.75	1.5	64	32
3	10,800	5,400	5,400	3.0	1.75	76	38

Notes:

1. Table assumes 2:1 side slopes.
2. Minimum depth is from trap bottom to weir crest and includes both wet and dry storage.
3. As an alternative to this table, the storage volume and trap dimensions can be calculated using the “average area method.”
5. Embankment – All embankments for sediment traps must not exceed 5 feet in height as measured at the low point of the original ground along the centerline of the embankment. Embankments must have a minimum 4-foot top width and side slopes of 2: 1 or flatter. The top of the embankment must be at least 1 foot above the crest of the riser.  
  
The elevation of the top of any dike directing water to any sediment trap will equal or exceed the maximum elevation of the embankment along the entire length of the trap.
6. Inlet – Convey runoff to the basin using stable diversions or temporary slope drains. Locate inflow points to maximize the distance to the outlet to prevent short-circuiting.
7. Depth – Excavate the basin a minimum of 1.5 feet to 2 feet below grade. Trap bottoms will generally be level. Plan view must indicate bottom dimensions. Show contours/grading of traps on plans to ensure constructability.
8. Outlet – Design, construct, and maintain the outlet in such a manner that sediment does not leave the trap and that erosion at or below the outlet does not occur. Sediment traps must outlet onto stabilized (preferably undisturbed) ground, into a watercourse, stabilized channel, or into an approved storm drain system.

There are two types of outlets: pipe outlet and stone outlet. A specific design criterion for each type follows.

Pipe Outlet Design Criteria

1. The outlet for the trap is through a perforated riser and an outlet pipe through the embankment. The outlet pipe and riser must be made of corrugated metal, HDPE, or PVC pipe. Include a means of conveying the discharge from the outlet in an erosion free manner to an existing stable channel. Provide protection against scour at the discharge end of the pipe

spillway in accordance with a practice from Chapter 4 Conveyance or Chapter 5 Water Control.

2. Where discharge occurs at the property line, meet local ordinances and drainage easement requirements.
3. All pipes must be circular and pipe connections watertight.
4. Use Table 6.2 for pipe sizing.
5. Design anti-seep collars in accordance with Figure 6.6 and Detail 602.4.
6. The top of the embankment must be at least 1 foot above the crest of the riser. The crest of the riser must be at least 1 foot above the top of the barrel.
7. Perforate the riser above the wet pool elevation. Perforations must be slits ½-inch wide by 6 inches in length for corrugated pipes or 1-inch diameter holes spaced 6 inches both vertically and horizontally.
8. No holes or slits will be allowed within 6 inches of the top of the horizontal barrel. Wrap the riser with ½-inch hardware cloth (wire) then wrap with Geotextile Class E (refer to Appendix A, Table A.1) at least 6 inches above the highest hole and 6 inches below the lowest hole and secure with strapping or connecting bands at the top and bottom of the cloth. The top of the riser pipe must have a trash rack/anti-vortex device that meets the requirements of Detail 602.3 and must not be covered with filter cloth.
9. The riser must have a base with sufficient weight to prevent flotation. Two approved bases are as follows:
  - (a) A concrete base that is 12 inches thick with the riser embedded 9 inches into the concrete.
  - (b) A ¼-inch minimum thickness steel plate attached to the riser by a continuous weld around the riser circumference to form a watertight connection with 2.5 feet of stone, gravel, or recycled concrete placed on the plate to prevent flotation.

In either case, each side of the square base measurement must be the riser diameter plus 24 inches.

**Table 6.2 Pipe Outlet Diameter Sizing**

Maximum Drainage Area (acres)	Minimum Barrel Diameter (inches)	Minimum Riser Diameter (inches)	Minimum Trash Rack Diameter (inches)	Minimum Height from Trap Bottom to Weir Crest (feet)	Minimum Embankment Height from Trap Bottom (feet)
1	15	21	30	2.5	4.0
2	21	27	42	2.75	4.25
3	24	33	48	3.0	4.5

Notes:

1. This table is to be used only under minimum tailwater conditions and inlet control.
2. An engineering design may be used as an alternative to this table.

**Stone Outlet Design Criteria**

1. The outlet of this trap is over a stone section placed on level ground.
2. Stone Size – Construct the outlet using well-graded stones with a  $d_{50}$  size of 4 inches (Class 0 erosion control stone is recommended), and a maximum stone size of 7 inches. Place a 1 foot thick layer of  $\frac{3}{4}$ -inch to  $1\frac{1}{2}$ -inch washed aggregate (refer to Appendix A, Table A.2) on the upstream face of the outlet.
3. Side Slopes – Keep the side slopes of the spillway section at 2:1 or flatter. To protect the embankment, keep the sides of the spillway at least 21 inches thick.
4. Stone Spillway Height – The sediment storage depth should be a minimum of 2 feet and a maximum of 3 feet above grade.
5. Protection from Piping – Place filter cloth on the foundation below the riprap to prevent piping. An alternative would be to excavate a cutoff trench across the riprap foundation and up the sides to the height of the dam.
6. Weir Length and Depth – Keep the spillway weir at least 4 feet long and sized to pass the peak discharge from the 15-year storm. A maximum flow depth of 6 inches, a minimum freeboard of 1 foot, and maximum side slopes of 2:1 are recommended. The minimum length weir (feet) of the outlet must be equal to 4 times the drainage area (acres). Weir length may be selected from Table 6.3.

**Table 6.3 Weir Length**

Drainage Area (acres)	Minimum Weir Length (feet)
1	4.0
2	6.0
3	12.0

### Trap details needed on Soil Erosion and Sediment Control Plans

There is no standard symbol for a sediment trap. Delineate each trap on the plans in such a manner that it will not be confused with any other features. Include on each plan all the information necessary to properly construct and maintain the trap. If the numbered information below is presented in tabular form, each trap on the plan must have a number and the numbers must be consecutive. Use caution when siting sediment traps; plot contours if necessary to ensure constructability. The following information, at a minimum, must be shown for each trap on the plans:

1. Trap number
2. Type of trap outlet
3. Drainage area (3 acres maximum)
4. Storage required (wet, dry, total)
5. Storage provided (wet, dry, total)
6. Weir length or pipe size
7. Storage depth below outlet and cleanout elevation
8. Embankment height and elevation (if applicable)
9. Number of baffles needed and locations (if applicable)
10. Typical trap detail
11. Elevations at trap bottom, wet storage, dry storage
12. Maintenance guidelines
13. Spillway and outlet dimension/details
14. Elevation for 15-year storm

#### **6.1.5 Construction Specifications**

##### Pipe Outlet Construction Specifications

1. Clear, grub, and strip the area under the embankment of any vegetation and root mat. Clear the pool area.
2. The fill material for the embankment must be free of roots or other woody vegetation as well as oversized stones, rocks, organic material, or other objectionable material. Place the fill in lifts not to exceed 9 inches, and machine compact it. Overfill the embankment 6 inches to allow for settlement.
3. All cut and fill slopes must be 2:1 or flatter.
4. All pipe connections must be watertight.
5. Carry out construction operations in such a manner that erosion and water pollution are abated. Once constructed, stabilize the top and outside face of the embankment with seed and mulch. Protect points of concentrated inflow in accordance with Chapter 4 Conveyance or

Chapter 5 Water Control criteria. Stabilize the remainder of the interior slopes (one time) with seed and mulch upon trap completion and monitor and maintain erosion free during the life of the trap.

Remove the structure and stabilize that area when the drainage area has been permanently stabilized.

6. Above the wet storage elevation, perforate the riser with ½-inch wide by 6-inch long slits or 1-inch diameter holes spaced 6 inches vertically and horizontally. No perforations will be allowed within 6 inches of the horizontal barrel.
7. Wrap the riser with ½-inch hardware cloth (wire) then wrap with Geotextile Class E (refer to Appendix A, Table A.2). Extend the geotextile fabric 6 inches above the highest slit and 6 inches below the lowest slit. Where ends of geotextile fabric come together, overlap, fold, and fasten them to prevent bypass. Replace geotextile fabric as necessary to prevent clogging.
8. Use straps or connecting bands to hold the geotextile fabric and wire fabric in place and place them at the top and bottom of the cloth.
9. Hand compact the fill material around the pipe spillway in 4-inch layers. Place a minimum of 2 feet of hand-compacted backfill over the pipe spillway before crossing it with construction equipment.

#### Stone Outlet Construction Specifications

1. Clear, grub, and strip the area under the embankment of any vegetation and root mat. Remove all surface soil containing high amounts of organic matter, and stockpile or dispose of it properly. Haul all objectionable material to the designated disposal area.
2. The fill material for the embankment must be free of roots and other woody vegetation, as well as over-sized stones, rocks, organic material, or other objectionable material. Place the fill in lifts not to exceed 9 inches, and machine compact it. Overfill the embankment 6 inches to allow for settlement.
3. Construct the outlet section in the embankment. Protect the connection between the riprap and the soil from piping by using geotextile or a keyway cutoff trench between the riprap structure and soil.
  - (a) Place geotextile Class SE over the bottom and sides of the outlet channel prior to the placement of stone. Sections of geotextile fabric must overlap at least 1 foot with the section nearest the entrance placed on top. Embed the geotextile fabric at least 6 inches into existing ground at the entrance of the outlet channel; or
  - (b) Excavate a cutoff trench along the centerline of the spillway foundation extending up the sides to the height of the dam. The trench must be at least 2 feet deep by 2 feet wide with 1:1 side slopes.
4. Clear the pond area below the elevation of the crest of the spillway to facilitate sediment cleanout.
5. All cut and fill slopes must be 2:1 or flatter.

6. Ensure that the stone (drainage) section of the embankment has a minimum top width of 4 feet and maximum side slopes of 2:1 that extend to the bottom of the spillway section.
7. Construct the minimum finished stone spillway bottom width, as shown on the plans, with 2:1 side slopes extending to the top of the over filled embankment. Keep the thickness of the sides of the spillway outlet structure at a minimum of 21 inches. The weir must be level and constructed to grade to assure design capacity.
8. Material used in the stone section must be a well-graded mixture of stone with a  $d_{50}$  size of 9 inches and a maximum stone size of 14 inches. The stone may be machine placed and the smaller stones worked into the voids of the larger stones. The stone should be hard, angular, and highly weather-resistant.
9. Discharge inlet water into the basin in a manner to prevent erosion. Use temporary slope drains or diversions with outlet protection to divert sediment-laden water to the upper end of the pool area to improve basin trap efficiency.
10. Ensure that the stone spillway outlet section extends downstream past the toe of the embankment until stable conditions are reached and the outlet velocity is acceptable for the receiving stream. Keep the edges of the stone outlet section flush with the surrounding ground, and shape the center to confine the outflow stream.
11. Direct emergency bypass to natural, stable areas. Locate bypass outlets so that flow will not damage the embankment.
12. Stabilize the embankment and all disturbed areas above the sediment pool and downstream from the trap immediately after construction and maintain erosion free during the life of the trap.
13. Show the distance from the top of the spillway to the sediment cleanout level (half the design depth) on the plans and mark it in the field.

#### **6.1.6 Maintenance**

Inspect temporary sediment traps at least weekly and after each significant (0.5-inch or greater) rainfall event and repair immediately. Sediment and debris must be removed and the trap restored to its original dimensions when sediment accumulates to the cleanout elevation (50% of the wet storage depth). Removed sediment must be deposited in an approved area in such a manner that it will not erode. The points of inflow and outflow as well as the interior of the trap must be cleared of any accumulated debris and kept free of erosion. The embankments must continuously meet the requirements for adequate vegetative establishment in accordance with Section 2.10 Vegetative Stabilization. Remove any trees, brush, or other woody vegetation growing on the embankment or near the principal spillway. Maintain the line, grade, and cross section.

##### Pipe Outlet Maintenance

Maintain watertight connections for the pipe outlet. If the dry storage volume in a pipe outlet sediment trap does not draw down within 10 hours, replace the geotextile around the perforated riser.

### Stone Outlet Maintenance

Check the structure for damage from erosion or piping. Periodically check the depth of the spillway to ensure it is a minimum of 1.5 feet below the low point of the embankment. Immediately fill any settlement of the embankment to slightly above design grade. Immediately replace any riprap displaced from the spillway.

### To Remove the Sediment Trap

Following completion of all construction and stabilization at a site, remove all temporary sediment traps and grade and stabilize the areas occupied by the traps. Silt fence or other sediment control devices may be required during trap removal. Refer to Chapter 7 for specifications concerning trap dewatering. Care must be taken when placing sediment traps in structural fill areas (i.e., proposed roadways and building foundations). When these traps are removed, remove the wet soil around the traps to facilitate compaction. Smooth the area to blend with the adjoining areas, and stabilize properly.



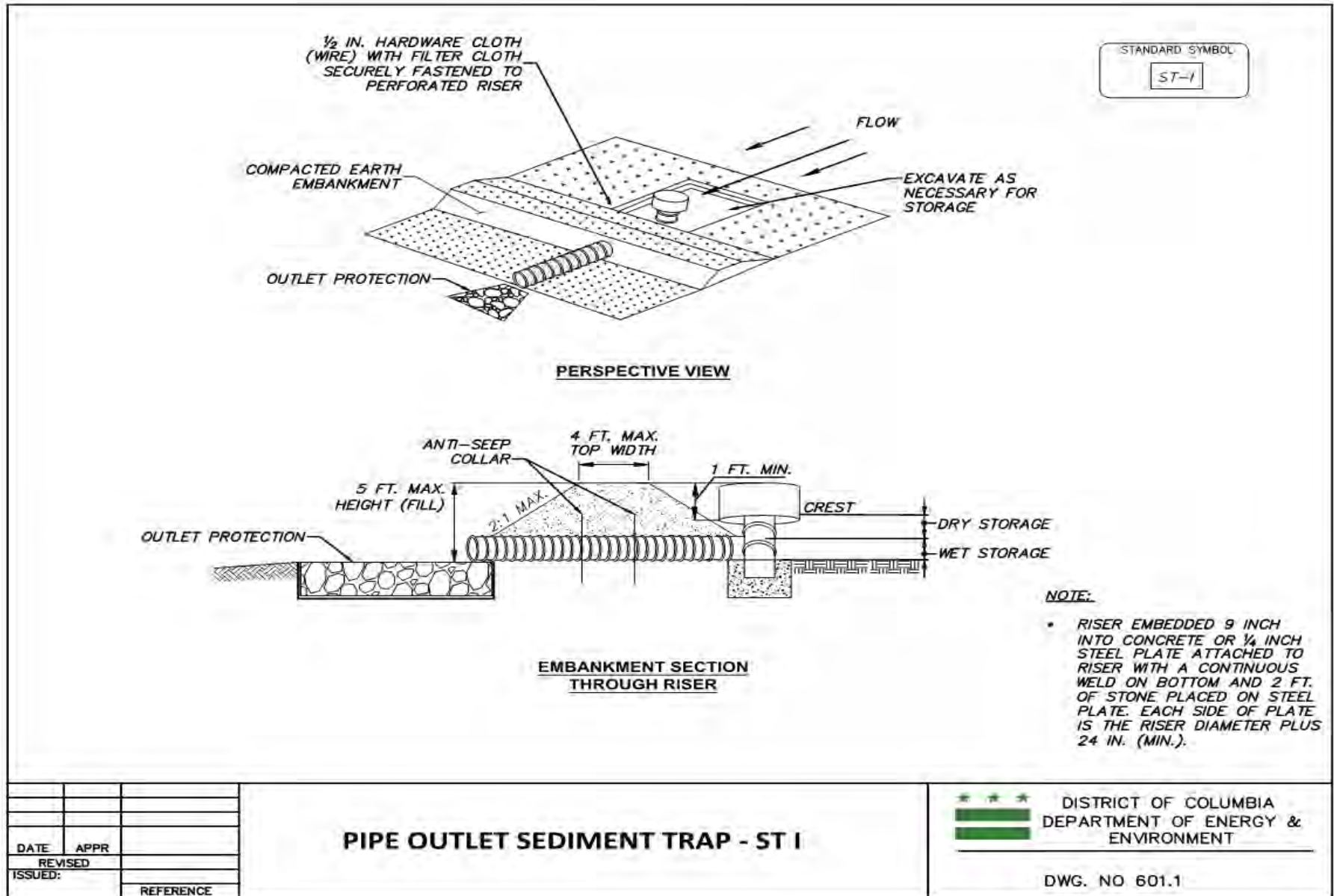

Detail 42 – 601.1 Pipe Outlet Sediment Trap - ST I

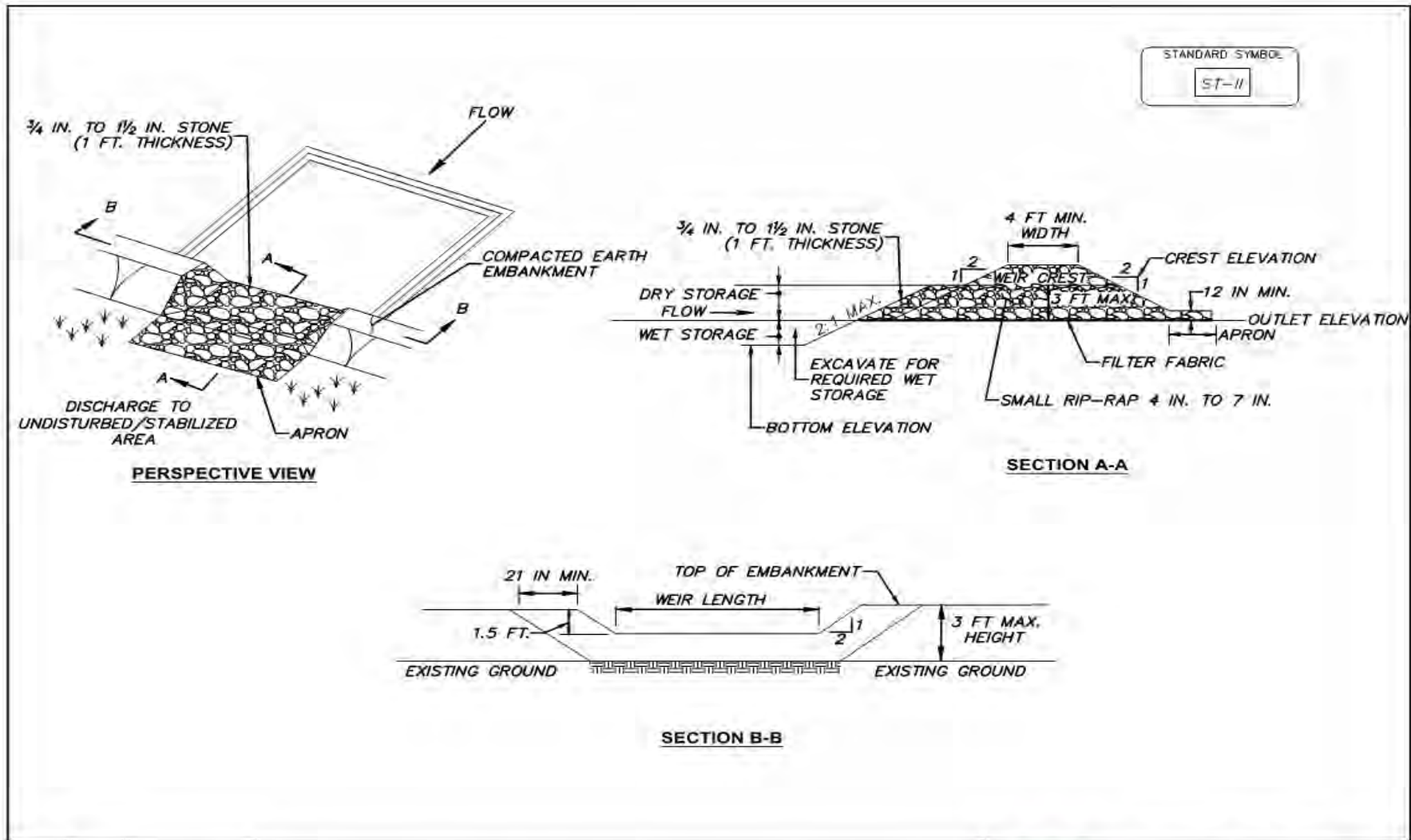

DATE	APPR	
REVISED		
ISSUED:		
	REFERENCE	

**STONE OUTLET SEDIMENT TRAP - ST II**

\*\*\* DISTRICT OF COLUMBIA  
 DEPARTMENT OF ENERGY &  
 ENVIRONMENT

DWG. NO 601.2

SOURCE: 2011 MARYLAND STANDARDS & SPECIFICATIONS

Detail 43 – 601.2 Stone Outlet Sediment Trap - ST II

## 6.2 Sediment Basins

### 6.2.1 Definition

A temporary barrier or dam constructed across a drainage way or a temporary pond formed by excavation and/or construction of an embankment and equipped with a drawdown device to intercept sediment-laden runoff. The temporary barrier may be combined with excavation to achieve the required storage.

### 6.2.2 Purpose

To protect downstream properties, rights-of-way, and drainage ways by trapping sediment and controlling the release of stormwater runoff.

### 6.2.3 Conditions Where Practice Applies

A sediment basin is required where sediment trap drainage areas are exceeded. This standard applies to the installation of temporary sediment basins on sites where the following conditions exist:

- Failure of the structure would not result in loss of life, damage to homes or buildings, or interruption of use or service of public roads or utilities;
- The drainage area does not exceed 100 acres;
- The maximum embankment height does not exceed 15 feet measured from the natural ground to the embankment top along the centerline of embankment; and
- The basin is to be removed within 36 months after the beginning of construction of the basin.

Use stormwater management ponds and bioretention practices as sediment basins if they meet the requirements of this section and the design and construction requirements of permanent stormwater management ponds or bioretention practices. See the DOEE Stormwater Management Guidebook for further guidance.

### 6.2.4 Design Criteria

#### Location

Select an area that includes the following:

- Provides capacity for sediment storage from as much of the planned disturbed area as practical;
- Excludes runoff from undisturbed areas where practical;
- Provides access for sediment removal throughout the life of the project;
- Interferes minimally with construction activities;
- Is at least 20 feet away from any existing building foundations;
- Ensures the groundwater elevation is lower than the bottom of the basin; and

- Is outside of structural fill areas (e.g., proposed roadways and building foundations).

### Storage Volume

The volume of the sediment basin, as measured from the bottom of the basin to the elevation of the principal spillway crest must be at least 3,600 cubic feet per acre for each acre of contributing drainage area or the calculated volume of runoff from a 2-year, 24-hour storm, whichever is greater. Divide the storage volume equally into "dry" or dewatered storage (1,800 cubic feet per acre) and "wet" or retention storage (1,800 cubic feet per acre). Provide a wet storage area with a minimum depth of 2 feet and 2:1 or flatter side slopes (starting at the lowest portion of the dry storage). Figure 6.1 illustrates the typical wet and dry storage volumes of basins.

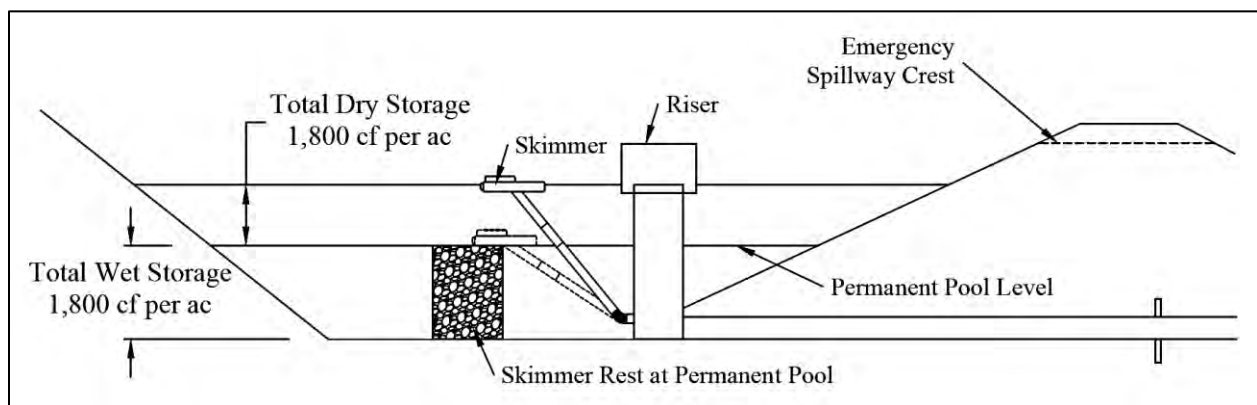

**Figure 6.1 Sediment basin storage volume.**

### Surface Area

Design basins so that the ratio of the surface area ( $\text{ft}^2$ ) at the elevation of the design high water elevation to discharge rate from a 15-year storm (cfs) is greater than or equal to 0.0035.

### Shape of the Basin

It is recommended that the designer of a sediment basin incorporate the following features:

- Length to width ratio greater than 2:1. When this condition cannot be met, baffles can be used to meet this requirement (see Detail 602.1 for baffle sizing and details). When baffles are used, the effective length to effective width ratio must be 2:1 or greater.
- A wedge shape with the inlet located at the narrow end.

### Inflows

Provide safe, non-erosive conveyance to the basin at all inflow points, as follows:

- Whenever the inflow to the basin is not stabilized or where concentrated runoff enters the basin, refer to Chapter 5 Water Control.

- Inflow protection provides safe conveyance of concentrated runoff into temporary sediment basins to prevent erosion. Inflow protection must meet or exceed the practices found in Chapter 4 Conveyance.
- Locate inflows as far from the riser as possible, to maximize travel time through the sediment basin.

### Embankment

Include in the embankment plans the elevations at the top of earth fill at constructed and settled height. For dam embankments up to 10 feet, the top must be level and a minimum of 8 feet in width. For embankments between 10 feet and 15 feet, the top width must be 10 feet in width.

### Side Slopes

Inside slopes must be 2:1 or flatter, and outside slopes must be 3:1 or flatter. Slopes must be designed to be stable in all cases.

### Skimmers

A skimmer is a dewatering control device that withdraws water from the basin's water surface, thus removing the highest quality water first from the basin. See Detail 602.2. By properly sizing the skimmer's control orifice, the skimmer can be made to dewater a design hydrologic event in a prescribed period.

Use Figure 6.2 to size the orifice plate for the skimmer shown in Detail 602.2. This figure assumes a 2-inch to 5-inch head (depending upon the size of the skimmer). The required head for use of Figure 6.2 varies as follows:

**Table 6.4 Head Requirements for Skimmer Design**

Tube Size (inches)	Head (inches)
< 2.5	2
3	2.5
4	3.3
5	4
6	5

To find the skimmer orifice diameter using Figure 6.2, first find the vertical line representing the basin's dewatering zone (i.e., dry storage) volume. At the intersection of the vertical line with the line representing a 3-day dewatering time, read horizontally to the left to find the required skimmer orifice diameter. Indicate this dimension on the plan drawings (as a note in the summary table). There must be a sufficient number of holes in the underside of the water entry unit of the skimmer to allow water to enter freely into the skimmer orifice. The outlet pipe or barrel must be capable of discharging at the rate permitted by the skimmer and in all cases must

be equal to or larger in dimension than the orifice diameter. Indicate this dimension on the plan drawings. Anti-seep collars are recommended for the barrel.

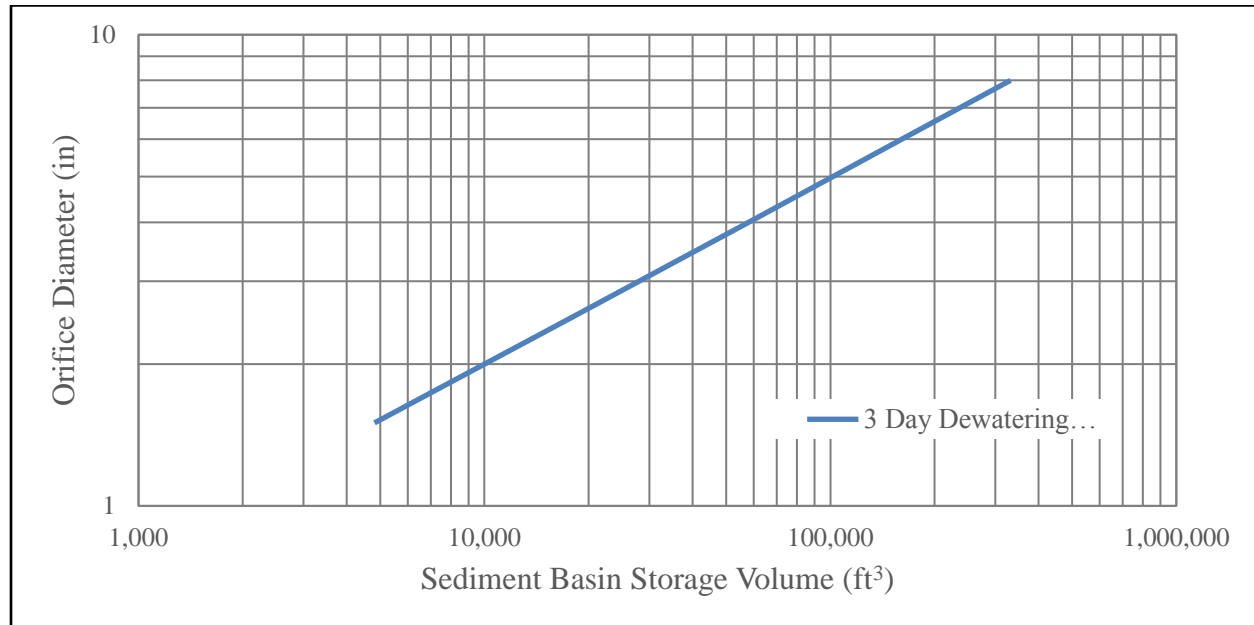

**Figure 6.2 Skimmer orifice design.**

Adapted from Penn State Agricultural and Biological Fact Sheet F-253.

### Principal Spillway

Provide a spillway that consists of a vertical pipe or box type riser joined (watertight connection) to a pipe (barrel) that extends through the embankment and outlet beyond the downstream toe of the fill (see Figure 6.3). Measure the storage volume required from the riser crest elevation to the bottom of the basin. The barrel must be the minimum diameter necessary to pass the peak discharge from 10% of the 15-year, 24-hour storm event ( $Q_{15}$ ) or 10 inches in diameter, whichever is larger. It is preferable to pass the 15-year storm event through the riser structure where possible.

When calculating the runoff volume, use the method outlined in Chapter 2, Estimating Runoff, in either the “Engineering Field Manual for Conservation Practices” (now the “Engineering Field Handbook”) or “TR-55, Urban Hydrology for Small Watersheds.” Base runoff computations upon the worst soil-cover conditions expected to prevail in the contributing drainage area during the anticipated effective life of the structure.

If an emergency spillway is not provided, the minimum cross-sectional area of the principal spillway must be 3 square feet and must have the capacity to pass the peak 15-year, 24-hour storm. It is preferable to design the riser to handle the peak 15-year, 24-hour storm and not have an emergency spillway. Note: If there is no emergency spillway, then  $Q_{ps} = Q_{10}$ .

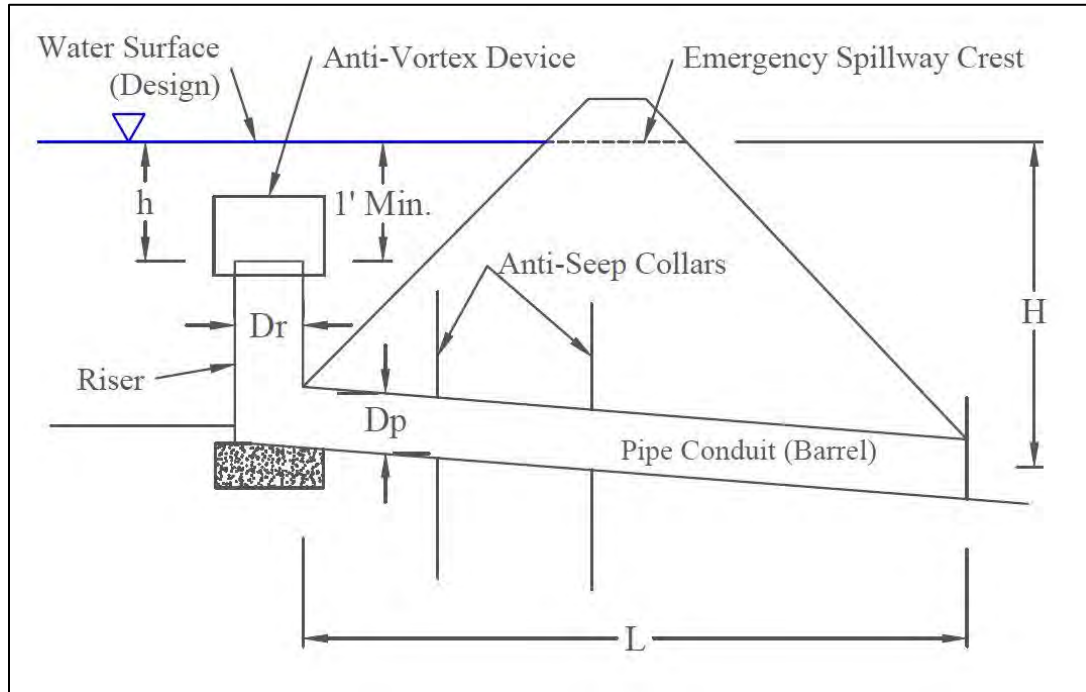

**Figure 6.3 Principle spillway.**

Where:

- H = head on pipe spillway (pipe flow) from centerline of outlet to emergency spillway crest or to design water if no emergency spillway (feet)
- h = head over riser crest (feet)
- L = length of pipe (feet)
- Dp = diameter of pipe conduit (barrel)
- Dr = diameter of riser

### Outlet

Provide an outlet, including a means of conveying the discharge in an erosion free manner to an existing stable channel. Where discharge occurs at the property line, obtain drainage easements in accordance with local ordinances. Show adequate notes and references concerning the easements on the erosion and sediment control plan. Provide protection against scour at the discharge end of the pipe spillway (see Chapter 5 Water Control).

Based on the storage volume, the topography in and around the basin, and using Figure 6.3, determine the length of the barrel (L) and the distance between the centerline of the outlet pipe and the design high water elevation (H) for the peak flow rate of the 15-year, 24-hour storm ( $Q_{15}$ ). Use Tables 6.5 and 6.6, or pond routing software to determine the barrel diameter corresponding to H and  $Q_{ps}$ . For pipes other than 70 feet, adjust the flow rates using the correction factors provided.

### Riser Sizing

Determine the riser diameter, height, and head over riser crest (h) to release the principle spillway discharge using the solid lines on Figure 6.4, or design the riser using pond routing software. The crest elevation of the riser must be a minimum of 1 foot below the elevation of the control section of the emergency spillway.



Table 6.5 Corrugated Metal Pipe Flow (cfs)

Height (feet)	Diameter (inches)													
	10	12	15	18	21	24	30	36	42	48	54	60	66	72
1	1.25	1.98	3.48	5.47	7.99	11.0	18.8	28.8	41.1	55.7	72.6	91.8	113	137
2	1.76	2.80	4.92	7.74	11.3	15.6	26.6	40.8	58.2	78.8	103	130	160	194
3	2.16	3.43	6.02	9.48	13.8	19.1	32.6	49.9	71.2	96.5	126	159	196	237
4	2.49	3.97	6.96	10.9	16.0	22.1	37.6	57.7	82.3	111	145	184	226	274
5	2.79	4.43	7.78	12.2	17.9	24.7	42.1	64.5	92.0	125	162	205	253	306
6	3.05	4.86	8.52	13.4	19.6	27.0	46.1	70.6	101	136	178	225	277	336
7	3.30	5.25	9.20	14.5	21.1	29.2	49.8	76.3	109	147	192	243	300	362
8	3.53	5.61	9.84	15.5	22.6	31.2	53.2	81.5	116	158	205	260	320	388
9	3.74	5.95	10.4	16.4	24.0	33.1	56.4	86.5	123	167	218	275	340	411
10	3.94	6.27	11.0	17.3	25.3	34.9	59.5	91.2	130	176	230	290	358	433
11	4.13	6.58	11.5	18.2	26.5	36.6	62.4	95.6	136	185	241	301	376	454
12	4.32	6.87	12.1	19.0	27.7	38.2	65.2	99.9	142	193	252	318	392	475
13	4.49	7.15	12.6	19.7	28.8	39.8	67.8	104.0	148	201	262	331	408	494
14	4.66	7.42	13.0	20.5	29.9	41.3	70.4	108.0	154	208	272	343	424	513
15	4.83	7.68	13.5	21.2	30.9	42.8	72.8	112.0	159	216	281	355	439	531

Length (feet)	Correction Factor for Other Pipe Lengths													
	20	30	40	50	60	70	80	90	100	120	140	160	20	30
20	1.58	1.53	1.47	1.42	1.37	1.34	1.28	1.24	1.20	1.18	1.16	1.14	1.13	1.11
30	1.39	1.36	1.32	1.29	1.27	1.24	1.21	1.18	1.15	1.13	1.12	1.11	1.10	1.09
40	1.25	1.23	1.21	1.20	1.18	1.17	1.14	1.12	1.11	1.10	1.09	1.08	1.07	1.06
50	1.15	1.14	1.13	1.12	1.11	1.10	1.09	1.08	1.07	1.06	1.06	1.05	1.05	1.04
60	1.07	1.06	1.06	1.05	1.05	1.05	1.04	1.04	1.03	1.03	1.03	1.02	1.02	1.02
70	1.00	1.00	1.00	1.00	1.00	1.00	1.00	1.00	1.00	1.00	1.00	1.00	1.00	1.00
80	0.95	0.95	0.95	0.95	0.96	0.96	0.96	0.97	0.97	0.97	0.98	0.98	0.98	0.98
90	0.90	0.90	0.91	0.91	0.92	0.92	0.93	0.94	0.94	0.95	0.95	0.96	0.96	0.96
100	0.86	0.86	0.87	0.88	0.89	0.89	0.90	0.91	0.92	0.93	0.93	0.94	0.94	0.95
120	0.79	0.80	0.81	0.82	0.83	0.83	0.85	0.86	0.87	0.89	0.89	0.90	0.91	0.92
140	0.74	0.75	0.76	0.77	0.78	0.79	0.81	0.82	0.84	0.85	0.86	0.87	0.88	0.89
160	0.69	0.70	0.71	0.73	0.74	0.74	0.77	0.79	0.80	0.82	0.83	0.84	0.85	0.86

Notes: Length = 70 feet;  $K_m = K_e + K_b = 1.00$ ; Full flow assumed;  $n = 0.025$

Example of how to apply the correction factor:

For  $L = 70$  ft,  $H = 5$  ft, and  $D = 36$  in,  $Q = 64.5$  cfs

For  $L = 50$  ft,  $H = 5$  ft, and  $D = 36$  in,  $Q = 64.5$  cfs  $\times 1.08 = 69.7$  cfs

**Table 6.6 Reinforced Concrete Pipe Flow (cfs)**

Height (feet)	Diameter (inches)																	
	12	15	18	21	24	30	36	42	48	54	60	66	72	78	84	90	96	102
1	3.08	5.17	7.83	11.1	14.9	24.2	35.8	49.7	65.8	84.2	105	128	153	180	210	242	276	312
2	4.35	7.31	11.1	15.7	21.0	34.2	50.6	70.3	93.1	119	148	181	216	255	297	342	390	441
3	5.33	8.95	13.6	19.2	25.8	41.9	62.0	86.1	114	146	182	221	265	312	363	419	478	541
4	6.15	10.3	15.7	22.1	29.8	48.4	71.6	99.4	132	168	210	255	306	360	420	483	552	624
5	6.88	11.6	17.5	24.4	33.3	54.1	80.1	111	147	188	234	286	342	403	469	540	617	698
6	7.54	12.7	19.2	27.1	36.4	59.3	87.7	122	161	206	257	313	374	441	514	592	676	765
7	8.14	13.7	20.7	29.3	39.4	64.0	94.8	131	174	223	277	338	404	477	555	640	730	826
8	8.70	14.6	22.2	31.3	42.1	68.5	101	141	186	238	297	361	432	510	594	684	780	883
9	9.23	15.5	23.5	33.2	44.6	72.6	107	149	197	253	315	383	459	541	630	725	827	936
10	9.73	16.3	24.8	35.0	47.0	76.5	113	157	208	266	332	404	483	570	664	764	872	987
11	10.2	17.1	26.0	36.7	49.3	80.3	119	165	218	279	348	424	507	598	696	802	915	1035
12	10.7	17.9	27.1	38.3	51.5	83.9	124	172	228	292	363	442	530	624	727	837	955	1081
13	11.1	18.6	28.2	39.9	53.6	87.3	129	179	237	304	378	461	551	650	757	872	994	1125
14	11.5	19.3	29.3	41.4	55.7	90.6	134	186	246	315	392	478	572	674	785	904	1032	1168
15	11.9	20.0	30.3	42.9	57.6	93.8	139	192	255	326	406	495	592	698	813	936	1068	1209

Length (feet)	Correction Factor for Other Pipe Lengths																	
20	1.30	1.24	1.21	1.18	1.15	1.12	1.10	1.08	1.07	1.06	1.05	1.05	1.04	1.04	1.03	1.03	1.03	1.03
30	1.22	1.18	1.15	1.13	1.12	1.09	1.08	1.07	1.05	1.05	1.04	1.04	1.03	1.03	1.03	1.02	1.02	1.02
40	1.15	1.13	1.11	1.10	1.08	1.07	1.05	1.05	1.04	1.03	1.03	1.03	1.02	1.02	1.02	1.02	1.02	1.02
50	1.09	1.08	1.07	1.06	1.05	1.04	1.04	1.03	1.03	1.02	1.02	1.02	1.02	1.01	1.01	1.01	1.01	1.01
60	1.04	1.04	1.03	1.03	1.03	1.02	1.02	1.02	1.01	1.01	1.01	1.01	1.01	1.01	1.01	1.01	1.01	1.01
70	1.00	1.00	1.00	1.00	1.00	1.00	1.00	1.00	1.00	1.00	1.00	1.00	1.00	1.00	1.00	1.00	1.00	1.00
80	0.96	0.97	0.97	0.97	0.98	0.98	0.98	0.99	0.99	0.99	0.99	0.99	0.99	0.99	0.99	0.99	0.99	0.99
90	0.93	0.94	0.94	0.95	0.95	0.96	0.97	0.97	0.98	0.98	0.98	0.98	0.98	0.99	0.99	0.99	0.99	0.99
100	0.90	0.91	0.92	0.93	0.93	0.95	0.95	0.96	0.97	0.97	0.97	0.98	0.98	0.98	0.98	0.98	0.98	0.99
120	0.84	0.86	0.87	0.89	0.90	0.91	0.93	0.94	0.94	0.95	0.96	0.96	0.96	0.97	0.97	0.97	0.97	0.98
140	0.80	0.82	0.83	0.85	0.86	0.88	0.90	0.91	0.92	0.93	0.94	0.94	0.95	0.95	0.96	0.96	0.96	0.97
160	0.76	0.78	0.80	0.82	0.83	0.86	0.88	0.89	0.90	0.91	0.92	0.93	0.94	0.94	0.95	0.95	0.95	0.96

Notes: Length = 70 feet;  $K_m = K_e + K_b = 1.00$ ; Full flow assumed;  $n = 0.013$

Example of how to apply the correction factor:

For  $L = 70$  ft,  $H = 5$  ft, and  $D = 36$  in,  $Q = 80.1$  cfs; For  $L = 50$  ft,  $H = 5$  ft, and  $D = 36$  in,  $Q = 64.5$  cfs  $\times 1.04 = 83.3$  cfs

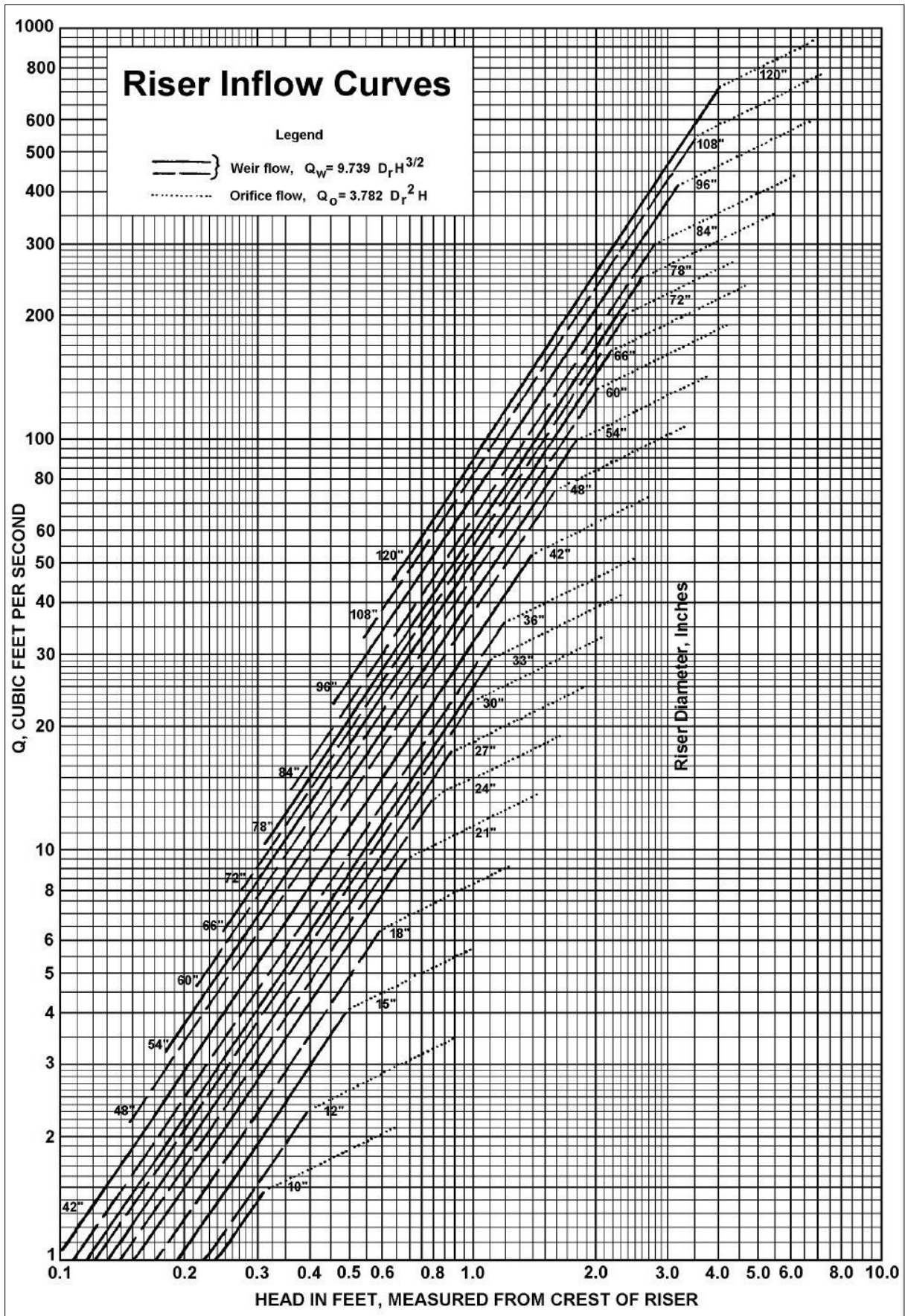

Figure 6.4 Riser inflow curves.

Anti-vortex Device and Trash Rack

Securely install a concentric type, anti-vortex device and trash rack on top of the riser. See Table 6.7 for sizing information and Detail 602.3 for design information.

**Table 6.7 Concentric Trash Rack and Anti-Vortex Device**

Trash Rack Cylinder				Minimum Size Support Bar	Minimum Top	
Riser Diameter (inches)	Diameter (inches)	Thickness (gauge)	Height (inches)		Thickness (gauge)	Stiffener (inches)
12	18	16	14	#6 rebar	16	N/A
15	21	16	15	#6 rebar	16	N/A
18	27	16	16	#6 rebar	16	N/A
21	30	16	9	#6 rebar	16	N/A
24	36	16	21	#6 rebar	14	N/A
27	42	16	21	#6 rebar	14	N/A
36	54	14	25	#8 rebar	12	N/A
42	60	14	27	#8 rebar	12	N/A
48	72	12	29	1¼-inch pipe or 1¼ × 1¼ × ¼ angle	10	N/A
54	78	12	33	1¼-inch pipe or 1¼ × 1¼ × ¼ angle	10	N/A
60	90	12	37	1½-inch pipe or 1½ × 1½ × ¼ angle	8	N/A
66	96	10	41	2-inch pipe or 2 × 2 × 3/16 angle	8	2 × 2 × ¼ angle
72	102	10	44	2-inch pipe or 2 × 2 × 3/16 angle	8	2½ × 2½ × ¼ angle
78	114	10	47	2½-inch pipe or 2 × 2 × ¼ angle	8	2½ × 2½ × ¼ angle
84	120	10	50	2½-inch pipe or 2 × 2 × ¼ angle	8	2½ × 2½ × 5/8 angle

Note: The trash rack and anti-vortex device information is for corrugated metal pipe only. Concrete risers must meet the requirements of NRCS 378.

### Riser Base

Attach a base to the riser with a watertight connection and ensure it has sufficient weight to prevent flotation of the riser. Two approved bases for risers 10 feet or less are (1) a concrete base 18 inches thick with the riser embedded 9 inches in the base, and (2) a ¼-inch minimum thickness steel base plate attached to the riser by a continuous weld around the circumference of the riser to form a watertight connection. The plate must have at least 2.5 feet of compacted earth, stone, or gravel placed over it to prevent flotation. In either case, each side of the square base must be twice the riser diameter.

Risers over 10 feet in height require anti-floatation calculations based on the following:

1. The riser must be analyzed for floatation assuming all orifices and pipes are plugged.
2. The factor of safety against floatation must be 1.2 or greater (downward forces = 1.2 × upward forces).

### Anti-Seep Collars

Anti-seep collars and their connections must be watertight and installed around all conduits through earth fills of impoundment structures according to the following criteria (refer to Figure 6.5):

1. Determine the length of pipe within the saturation zone of the embankment ( $L_s$ ) either graphically or by using the following equation, assuming that the upstream slope of the embankment intersects the invert of the pipe at its upstream end and that the slope of the pipe ( $S_o$ ) is constant.

$$L_s = \frac{Y(z + 4)}{1 - 4 \times S_o}$$

Where:

- $L_s$  = length of pipe in the saturated zone (ft)
- $Y$  = distance from upstream invert of pipe to highest normal water level expected to occur during the life of the structure, usually the top of the riser (ft)
- $z$  = slope of upstream embankment as a ratio of  $z$  ft. horizontal to 1 ft.
- $S_o$  = slope of pipe in feet per foot.

2. Determine the vertical projection ( $P_1$ ) required to increase  $L_s$  by 15% either graphically as shown in Figure 6.6 or by using the equation:

$$P_1 = 0.075 \times L_s$$

3. Choose the actual vertical projection (2 feet minimum) of each anti-seep collar ( $P$ ) by rounding up  $P_1$  or rounding down  $P_1$  and using multiple collars.
4. Determine the number of anti-seep collars ( $N$ ) required of the chosen vertical projection ( $P$ ) using equation:

$$PN = \frac{P_1}{P}$$

5. Either round up N or repeat steps 3 and 4 to determine optimum P/N relationship.
6. Provide construction specifications relative to the materials to be used and method for anchoring the anti-seep collar(s) to the pipe in a watertight manner (see Detail 602.4).
7. Anti-seep collar spacing must be between 5 and 14 times the vertical projection of each collar.
8. Extend anti-seep collar dimensions a minimum of 2 feet in all directions around the pipe.
9. Place anti-seep collars a minimum of 2 feet from pipe joints.
10. Place anti-seep collars within the saturation zone. In cases where the spacing limit will not allow this, place at least one collar in the saturation zone.

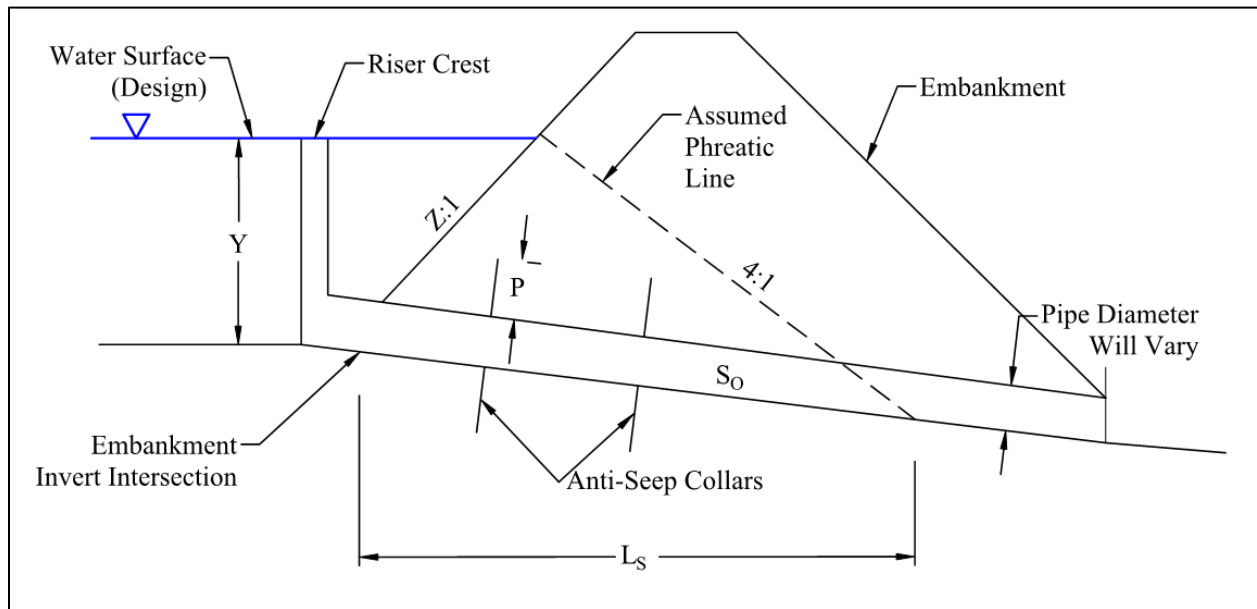

**Figure 6.5 Anti-seep collars.**

Where:

- P = vertical projection of anti-seep collar (feet)
- L<sub>s</sub> = length of pipe in the saturated zone (feet)
- Y = distance in feet from upstream invert of pipe to highest normal water level expected to occur during the life of the structure, usually the top of the riser
- z = slope of upstream embankment as a ratio of z feet horizontal to 1 foot vertical
- S<sub>0</sub> = slope of pipe in feet per foot

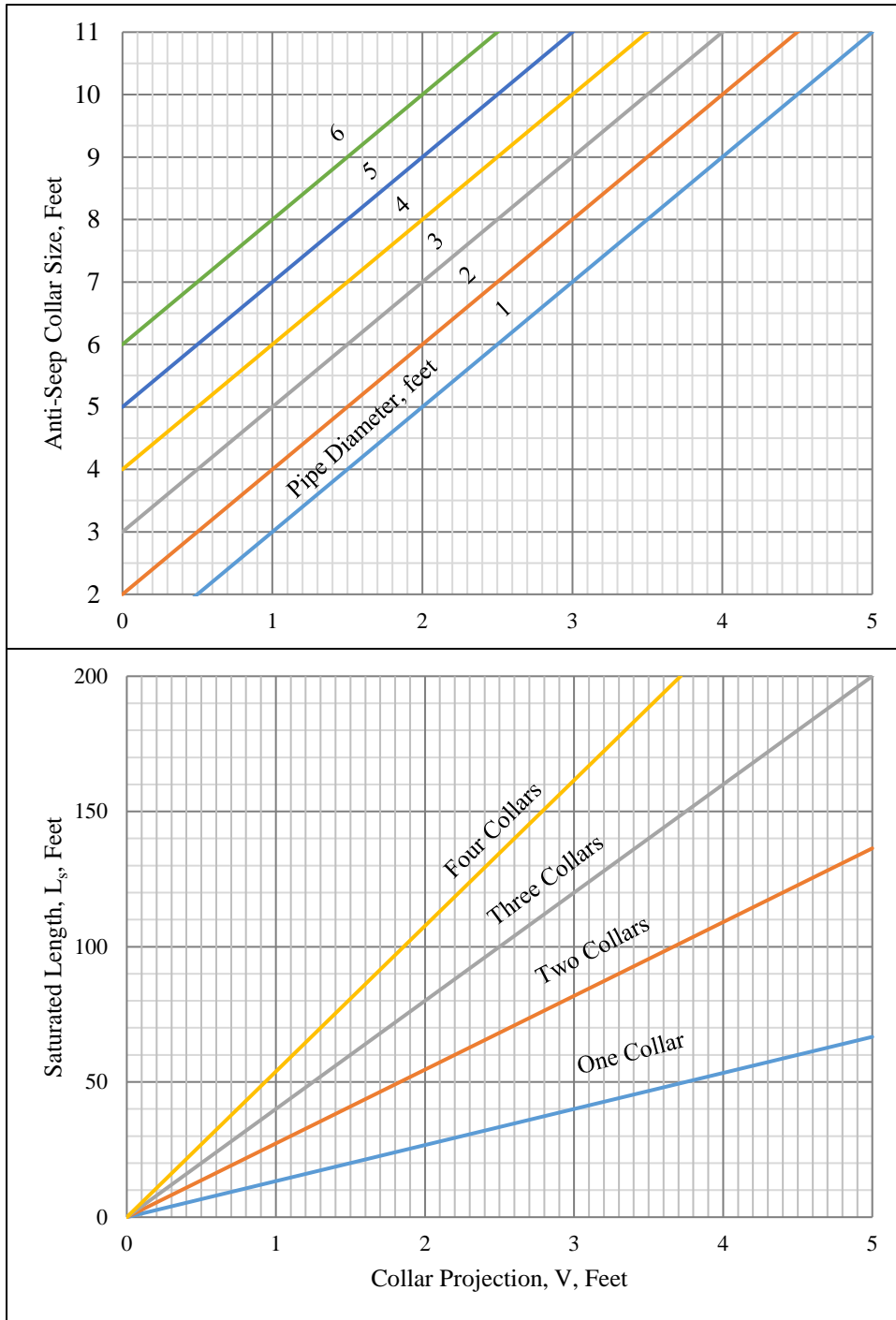

**Figure 6.6 Anti-seep collar design.**

Example: If  $L_s = 70$  ft, and using 3 collars with a collar projection of 1.8 ft and a pipe diameter = 3 ft, then the collar size needs to be 7.6 ft

### Emergency Spillway

An emergency spillway is required when the primary spillway is not designed to convey the 15-year storm event. Construct the entire flow area of the emergency spillway in undisturbed ground (not fill). The emergency spillway cross-section must be trapezoidal with a minimum bottom width of 8 feet and side slopes of 3:1 or flatter. This spillway channel must have a straight, level control section of at least 25 feet in length. The exit channel section must have sufficient slope such that the discharge capacity of the spillway is not hindered in any way and allows the discharge to be released at a non-erosive velocity.

1. Capacity – The minimum capacity of the emergency spillway must pass the peak rate of runoff from the 15-year 24-hour duration storm, less any reduction due to flow in the principal spillway. Emergency spillway dimensions may be determined by using the method in Detail 602.5 and the look-up values provided in Table 6.8.
2. Velocities – Do not exceed the 5 feet per second velocity of flow in the exit channel for vegetated channels during a 10-year runoff event. For channels with erosion protection other than vegetation, velocities must be within the non-erosive range for the type of protection used.
3. Freeboard – Freeboard is the difference between the design high water elevation in the emergency spillway and the top of the settled embankment. Freeboard must be at least 1 foot. If no emergency spillway is provided, the minimum freeboard above the riser must be 2 feet. To allow for settlement, design the top of the dam elevation to include a minimum 10% increase in height.



**Table 6.8 Design Data for Earth Spillway (use in conjunction with Detail 602.5)**

Stage (Hp) (ft)	Spillway Variables	Bottom Width (b) (ft)																
		8	10	12	14	16	18	20	22	24	26	28	30	32	34	36	38	40
0.5	Q	6	7	8	10	11	13	14	15	17	18	20	21	22	24	25	27	28
	V	2.7	2.7	2.7	2.7	2.7	2.7	2.7	2.7	2.7	2.7	2.7	2.7	2.7	2.7	2.7	2.7	2.7
	S	3.9	3.9	3.9	3.9	3.8	3.8	3.8	3.8	3.8	3.8	3.8	3.8	3.8	3.8	3.8	3.8	3.8
0.6	Q	8	10	12	14	16	18	20	22	24	26	28	30	32	34	35	37	39
	V	3	3	3	3	3	3	3	3	3	3	3	3	3	3	3	3	
	S	3.7	3.7	3.7	3.7	3.6	3.7	3.6	3.6	3.6	3.6	3.6	3.6	3.6	3.6	3.6	3.6	
0.7	Q	11	13	16	18	20	23	25	28	30	33	35	38	41	43	44	46	48
	V	3.2	3.2	3.3	3.3	3.3	3.3	3.3	3.3	3.3	3.3	3.3	3.3	3.3	3.3	3.3	3.3	
	S	3.5	3.5	3.4	3.4	3.4	3.4	3.4	3.4	3.4	3.4	3.4	3.4	3.4	3.4	3.4	3.4	
0.8	Q	13	16	19	22	26	29	32	35	38	42	45	46	48	51	54	57	60
	V	3.5	3.5	3.5	3.6	3.6	3.6	3.6	3.6	3.6	3.6	3.6	3.6	3.6	3.6	3.6	3.6	
	S	3.3	3.3	3.3	3.2	3.2	3.2	3.2	3.2	3.2	3.2	3.2	3.2	3.2	3.2	3.2	3.2	
0.9	Q	17	20	24	28	32	35	39	43	47	51	53	57	60	64	68	71	75
	V	3.7	3.8	3.8	3.8	3.8	3.8	3.8	3.8	3.8	3.8	3.8	3.8	3.8	3.8	3.8	3.8	
	S	3.2	3.1	3.1	3.1	3.1	3.1	3.1	3.1	3.1	3.1	3.1	3.1	3.1	3.1	3.1	3.1	
1.0	Q	20	24	29	33	38	42	47	51	56	61	63	68	72	77	81	86	90
	V	4	4	4	4	4	4	4	4	4	4	4	4	4	4	4	4	
	S	3.1	3	3	3	3	3	3	3	3	3	3	3	3	3	3	3	
1.1	Q	23	28	34	39	44	49	54	60	65	70	74	79	84	89	95	100	105
	V	4.2	4.2	4.2	4.3	4.3	4.3	4.3	4.3	4.3	4.3	4.3	4.3	4.3	4.3	4.3	4.3	
	S	2.9	2.9	2.9	2.9	2.9	2.9	2.9	2.9	2.9	2.8	2.8	2.8	2.8	2.8	2.8	2.8	
1.2	Q	28	33	40	45	51	58	64	69	76	80	86	92	98	104	110	116	122
	V	4.4	4.4	4.4	4.4	4.4	4.5	4.5	4.5	4.5	4.5	4.5	4.5	4.5	4.5	4.5	4.5	
	S	2.9	2.9	2.8	2.8	2.8	2.8	2.8	2.8	2.8	2.8	2.8	2.8	2.8	2.8	2.8	2.8	
1.3	Q	32	38	46	53	58	65	73	80	86	91	99	106	112	119	125	133	140
	V	4.5	4.6	4.6	4.6	4.6	4.6	4.7	4.7	4.7	4.7	4.7	4.7	4.7	4.7	4.7	4.7	
	S	2.8	2.8	2.7	2.7	2.7	2.7	2.7	2.7	2.7	2.7	2.7	2.7	2.7	2.7	2.7	2.7	
1.4	Q	37	44	51	59	66	74	82	90	96	103	111	119	127	134	143	150	158
	V	4.8	4.8	4.8	4.8	4.8	4.8	4.8	4.8	4.8	4.9	4.9	4.9	4.9	4.9	4.9	4.9	
	S	2.8	2.7	2.7	2.7	2.7	2.7	2.7	2.6	2.6	2.6	2.6	2.6	2.6	2.6	2.6	2.6	
1.5	Q	41	50	58	66	75	85	92	101	108	116	125	133	142	150	160	169	178
	V	4.8	4.9	5	5	5	5	5	5	5	5	5	5	5	5.1	5.1	5.1	
	S	2.7	2.7	2.6	2.6	2.6	2.6	2.6	2.6	2.6	2.6	2.6	2.6	2.6	2.5	2.5	2.5	
1.6	Q	46	56	65	75	84	94	104	112	122	132	142	149	158	168	176	187	197
	V	5	5.1	5.1	5.1	5.1	5.2	5.2	5.2	5.2	5.2	5.2	5.2	5.2	5.2	5.2	5.2	
	S	2.6	2.6	2.6	2.6	2.5	2.5	2.5	2.5	2.5	2.5	2.5	2.5	2.5	2.5	2.5	2.5	
1.7	Q	52	62	72	83	94	105	115	126	135	145	156	167	175	187	196	206	217
	V	5.2	5.2	5.3	5.3	5.3	5.3	5.4	5.4	5.4	5.4	5.4	5.4	5.4	5.4	5.4	5.4	
	S	2.6	2.6	2.5	2.5	2.5	2.5	2.5	2.5	2.5	2.5	2.5	2.5	2.5	2.5	2.5	2.5	
1.8	Q	58	69	81	93	104	116	127	138	150	160	171	182	194	204	214	226	233
	V	5.3	5.4	5.4	5.5	5.5	5.5	5.5	5.5	5.5	5.5	5.5	5.5	5.6	5.6	5.6	5.6	
	S	2.5	2.5	2.5	2.5	2.4	2.4	2.4	2.4	2.4	2.4	2.4	2.4	2.4	2.4	2.4	2.4	
1.9	Q	64	76	88	102	114	127	140	152	164	175	188	201	213	225	235	248	230
	V	5.5	5.5	5.5	5.6	5.6	5.6	5.7	5.7	5.7	5.7	5.7	5.7	5.7	5.7	5.7	5.7	
	S	2.5	2.5	2.5	2.4	2.4	2.4	2.4	2.4	2.4	2.4	2.4	2.4	2.4	2.4	2.4	2.4	
2.0	Q	71	83	97	111	125	138	153	164	178	193	204	218	232	245	256	269	283
	V	5.6	5.7	5.7	5.7	5.8	5.8	5.8	5.8	5.8	5.8	5.8	5.9	5.9	5.9	5.9	5.9	
	S	2.5	2.4	2.4	2.4	2.4	2.4	2.4	2.4	2.3	2.3	2.3	2.3	2.3	2.3	2.3	2.3	
2.1	Q	77	91	107	122	135	149	162	177	192	207	220	234	250	267	276	291	305
	V	5.7	5.8	5.9	5.9	5.9	5.9	5.9	6	6	6	6	6	6	6	6	6	
	S	2.4	2.4	2.4	2.3	2.3	2.3	2.3	2.3	2.3	2.3	2.3	2.3	2.3	2.3	2.3	2.3	
2.2	Q	84	100	116	131	146	163	177	194	210	224	238	253	269	288	301	314	330
	V	5.9	5.9	6	6	6	6.1	6.1	6.1	6.1	6.1	6.1	6.1	6.1	6.2	6.2	6.2	
	S	2.4	2.4	2.4	2.3	2.3	2.3	2.3	2.3	2.3	2.3	2.3	2.3	2.3	2.3	2.3	2.3	

Note: Data to the right of the heavy vertical lines should be used with caution, as the resulting sections will be either poorly proportioned or have velocities in excess of 6 feet per second.

### Information to be Submitted

Sediment basin designs and construction plans submitted for review must include the following:

1. Sizing calculations for sediment storage within the basin, including an estimate of dry and wet storage.
2. Sediment controls necessary for the installation of the basin.
3. Specific location of the basin.
4. Plan view of the basin and emergency spillway showing existing and proposed contours.
5. Cross section of dam, including elevations at the top of earth fill at constructed and settled height, principal spillway and emergency spillway; profile of emergency spillway.
6. Details of pipe connections, riser to pipe connections, riser base, anti-seep collars, trash rack, cleanout elevation, and anti-vortex device.
7. Runoff calculations for the 15-year frequency storm assuming worst soil conditions.
8. Maintenance equipment access points.
9. Dewatering method (sump pit, etc.).
10. Bottom dimensions of the basin.
11. Drainage area map clearly showing the maximum contributing drainage area to reach the basin.

### **6.2.5 Construction Specifications**

1. Site Preparation – Install perimeter sediment control devices prior to clearing and grubbing. Clear, grub, and strip areas of topsoil where the embankment is to be placed to remove trees, vegetation, roots, or other objectionable material. Do not clear the pool area until completion of the dam embankment unless the pool area is to be used for borrow. In order to facilitate clean-out and restoration, clear the pool area (measured at the top of the pipe spillway) of all brush, trees, and other objectionable materials.
2. Cutoff Trench – Excavate a cutoff trench along the centerline of earth fill embankments. The minimum depth must be 4 feet. Extend the trench up both abutments to the riser crest elevation. The minimum bottom width must be 2 feet, but wide enough to permit operation of excavation and compaction equipment. The side slopes must be no steeper than 1:1. Compaction requirements must be the same as those for the embankment. Dewater the trench during the backfilling-compaction operations. See Chapter 7 Dewatering.
3. Embankment – Take the fill material from approved areas shown on the plans, and clear mineral soil of roots, woody vegetation, oversized stones, rocks, or other objectionable material. Do not place relatively pervious materials such as sand or gravel (Unified Soil Classes GW, GP, SW, and SP) or organic materials (Unified Soil Classes OL and OH) in the embankment. Scarify areas on which fill is to be placed prior to placement of fill. The fill material must contain sufficient moisture so that it can be formed by hand into a ball without crumbling. If water can be squeezed out of the ball, it is too wet for proper compaction. Place fill material in 6-inch to 8-inch thick continuous lifts over the entire length of the fill. Obtain

compaction by routing and hauling the construction equipment over the fill so that the entire surface of each layer of the fill is traversed by at least one wheel or tread track of the equipment or using a compactor. Construct the embankment to an elevation 10% higher than the design height to allow for settlement.

4. **Principal Spillway** – Securely attach steel risers to the barrel or barrel stub by welding the full circumference and making a watertight structural connection. Pour concrete risers with the principal spillway in place or precast with voids around the principal spillway and fill with concrete or shrink proof grout for watertight connection. The barrel stub must be attached to the riser at the same percent (angle) of grade as the outlet conduit. The connection between the riser and the riser base must be watertight. All connections between barrel sections must be achieved by approved watertight band assemblies. Place the barrel and riser on a firm, smooth foundation of impervious soil as the embankment is constructed. Breaching the embankment to install the barrel is unacceptable. Do not use pervious materials such as sand, gravel, or crushed stone as backfill around the pipe or anti-seep collars. Place the fill material around the pipe spillway in 4-inch lifts and hand compact under and around the pipe to at least the same density as the adjacent embankment. Backfill a depth of 1.5 times the pipe diameter (minimum) over the principal spillway and hand compact before crossing it with construction equipment.
5. **Emergency Spillway** – Install the emergency spillway in undisturbed ground. The achievement of planned elevations, grades, design width, and entrance and exit channel slopes are critical to the successful operation of the emergency spillway and must be constructed within a tolerance of + 0.2 feet.
6. **Vegetative Treatment** – Stabilize the embankment in accordance with Section 2.10 Vegetative Stabilization immediately following construction. The embankment must not remain unstabilized for more than 7 days. Once constructed, stabilize the top and outside face of the embankment with seed and mulch. Stabilize the remainder of the interior slopes (one time) with seed and mulch. Upon basin completion, monitor and maintain erosion free during the life of the basin.
7. **Safety** – Meet local requirements concerning fencing and signs, warning the public of hazards of soft sediment and floodwater.

### **6.2.6 Maintenance**

Repair all damage caused by soil erosion and construction equipment at or before the end of each working day. The volume of the basin for cleanout of settled sediment is 900 cubic feet per acre for each acre of drainage area (one-half the wet storage depth). When the basin fills with sediment to this volume, remove the sediment to restore the original design volume.

Indicate on the sediment control plan the method(s) of disposing the sediment removed from the basin. Do not place the sediment in such a manner to allow erosion from the site. Do not deposit the sediment downstream from the basin or adjacent to a stream or floodplain.

#### Final Disposal

When the sediment basin has served its intended purpose and the contributing drainage area has been properly stabilized, level or otherwise dispose of the embankment and resulting sediment

deposits in accordance with the approved sediment control plan. If the site is scheduled for future construction, then remove and safely dispose of the basin material and trapped sediments and backfill the basin with a structural fill. When the basin area is to remain open space, the pond may be pumped dry (using methods in Chapter 7 Dewatering), graded, and backfilled.

#### Conversion to Stormwater Management Structure

After permanent stabilization of all disturbed contributory drainage areas, temporary sediment basins, if initially built and certified to meet permanent standards, may be converted to permanent stormwater management structures. To convert the basin from temporary to permanent use, modify the outlet structure in accordance with approved stormwater management design plans. Additional grading may also be necessary to provide the required storage volume in the basin. Conversion can only take place after all disturbed areas have been permanently stabilized to the satisfaction of the inspection authority and storm drains have been flushed.

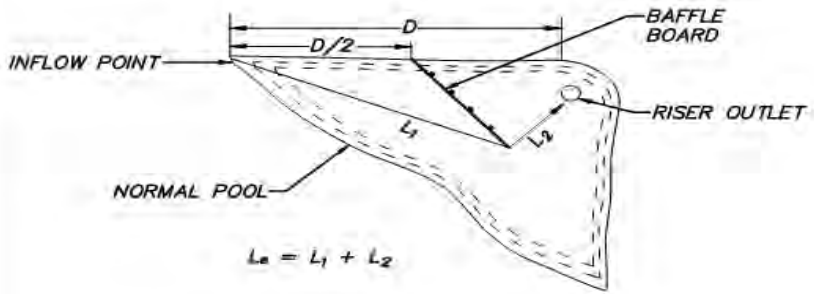
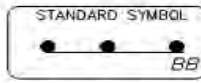

PLAN VIEW

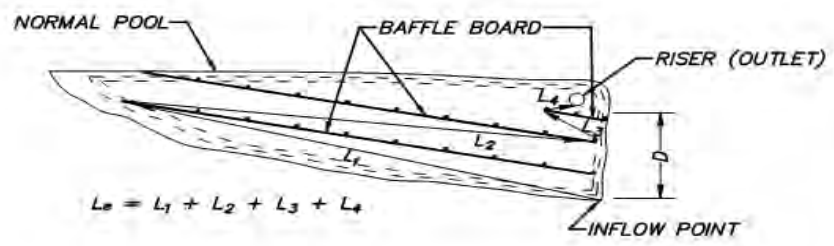

PLAN VIEW

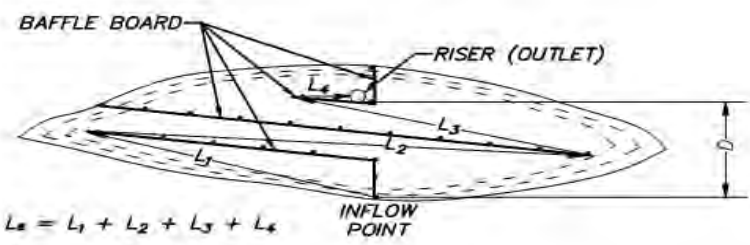

PLAN VIEW

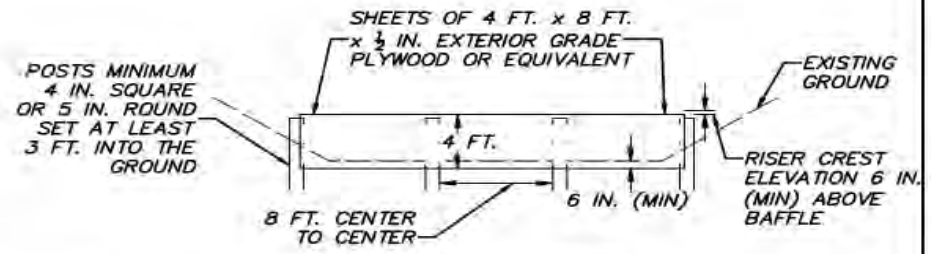

BAFFLE DETAIL

D = DISTANCE BETWEEN INFLOW AND OUTFLOW

A = AREA OF PERMANENT POOL

W<sub>e</sub> = EFFECTIVE WIDTH

L<sub>e</sub> = TOTAL DISTANCE FROM THE INFLOW POINT AROUND THE BAFFLES TO THE RISER.

FORMULA:  $W_e = (A/2)^{1/2}$   
 $L_e \geq W_e \times 2$

DATE	APPR	
REVISED		
ISSUED:		
	REFERENCE	

### BAFFLE BOARDS SEDIMENT BASIN

★ ★ ★ DISTRICT OF COLUMBIA  
 DEPARTMENT OF ENERGY &  
 ENVIRONMENT

DWG. NO 602.1

SOURCE: 2011 MARYLAND STANDARDS & SPECIFICATIONS

Detail 44 – 602.1 Baffle Boards

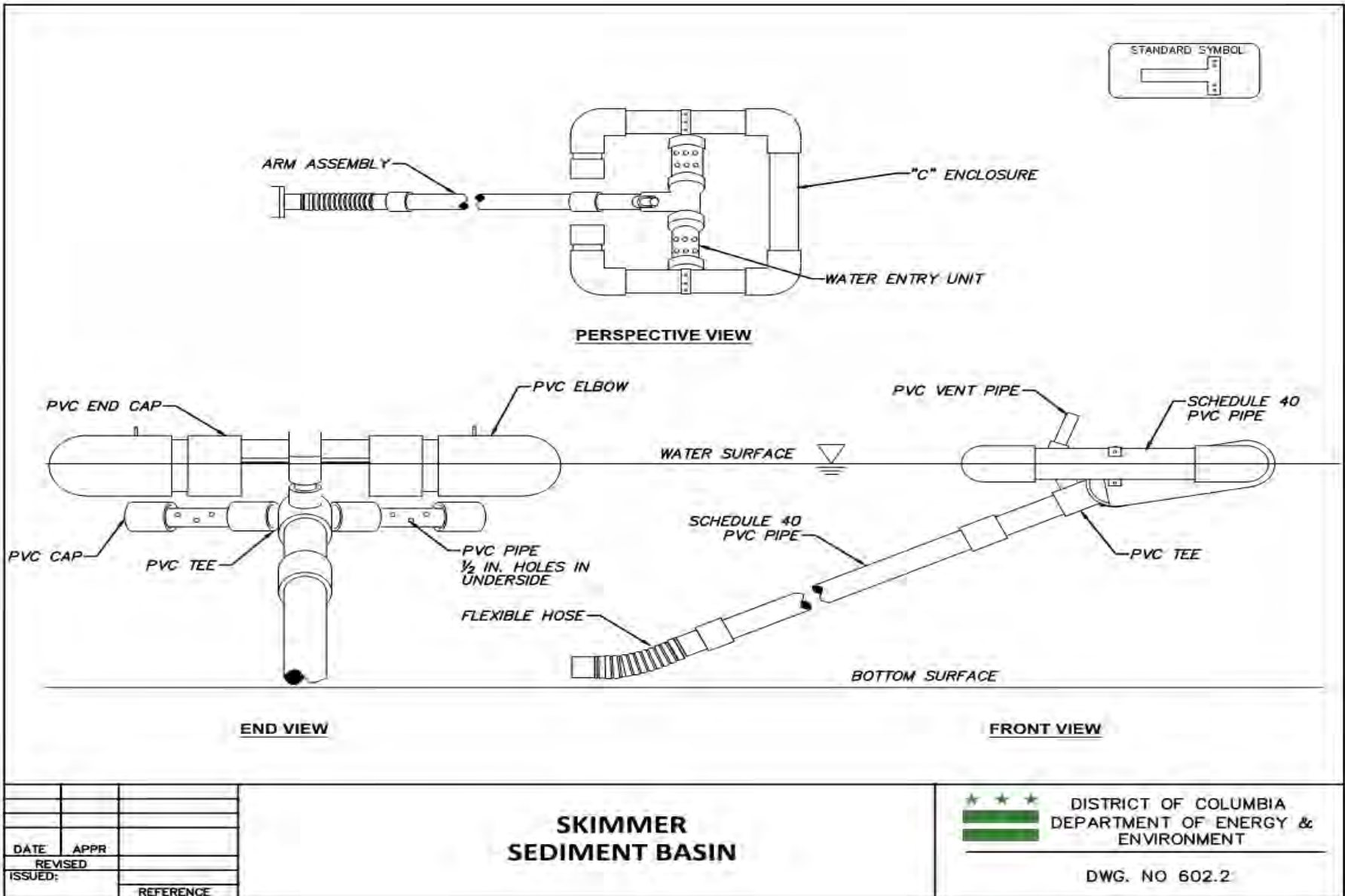

Detail 45 – 602.2 Skimmer

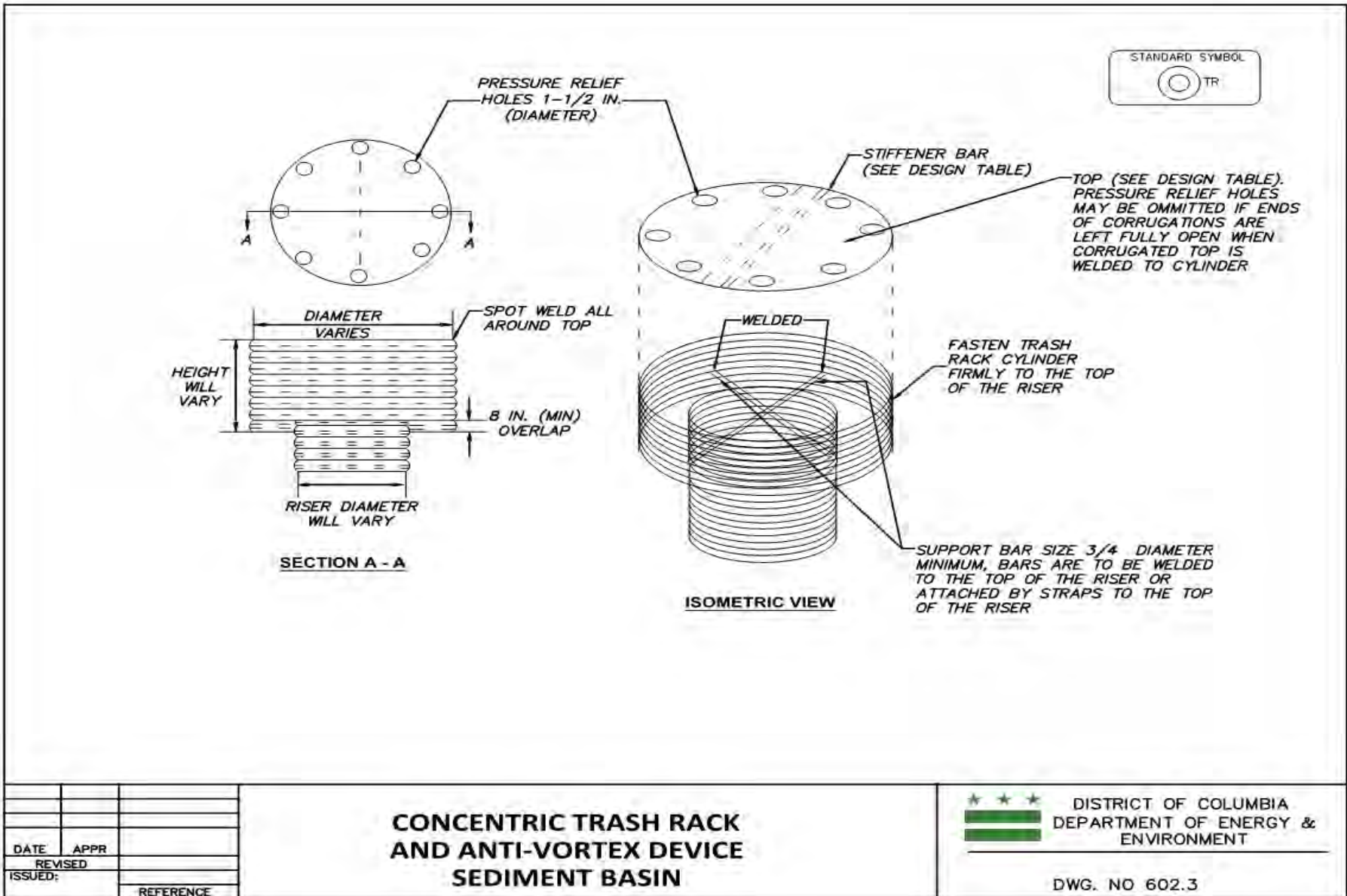

DATE	APPR	
REVISED		
ISSUED:		
	REFERENCE	

**CONCENTRIC TRASH RACK  
AND ANTI-VORTEX DEVICE  
SEDIMENT BASIN**

★ ★ ★ DISTRICT OF COLUMBIA  
DEPARTMENT OF ENERGY &  
ENVIRONMENT

DWG. NO 602.3

(SOURCE) 2B(1) MARYLAND STANDARDS & SPECIFICATIONS

Detail 46 – 602.3 Concentric Trash Rack and Anti-Vortex Device



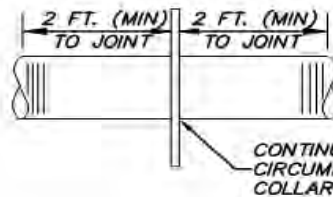
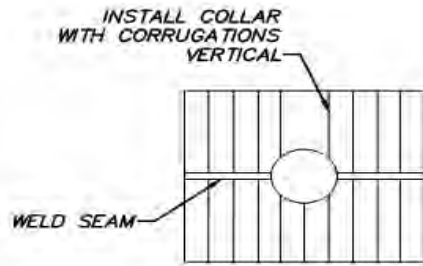

THE LAST TWO CORRUGATIONS, MINIMUM, ON EACH END MUST BE ANNULAR OR FLANGE

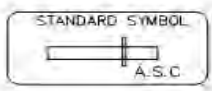

**COLLAR WELDED IN PLACE ON BARREL SECTION**

PLATES TO BE PRECUT, CLAMPED TOGETHER, PRE-DRILLED, AND LABELED TO FACILITATE WATERTIGHT FIELD ASSEMBLY

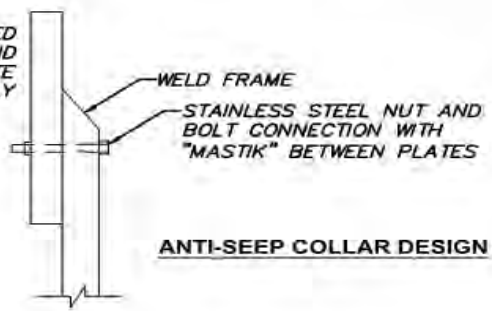

**ANTI-SEEP COLLAR DESIGN**

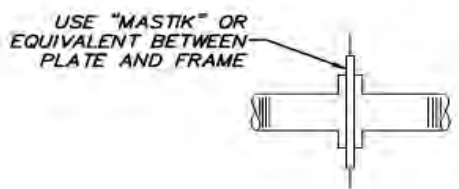
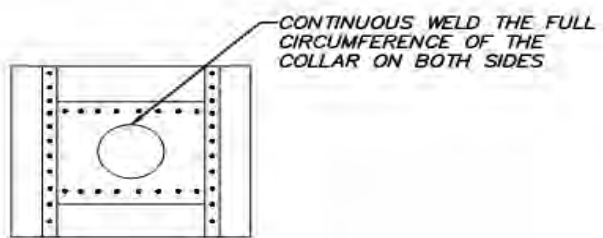

**COLLAR FOR FLANGE JOINT PIPE**

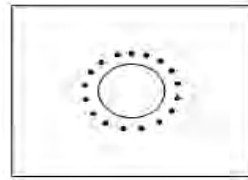

DATE	APPR	
REVISED		
ISSUED:		
	REFERENCE	

**TYPICAL ANTI-SEEP COLLARS  
SEDIMENT BASIN**

\*\*\* DISTRICT OF COLUMBIA  
DEPARTMENT OF ENERGY &  
ENVIRONMENT

DWG. NO 602.4

(SOURCE: 801) MARYLAND STANDARDS & SPECIFICATIONS

Detail 47 – 602.4 Typical Anti-Seep Collars



STANDARD SYMBOL  
ES

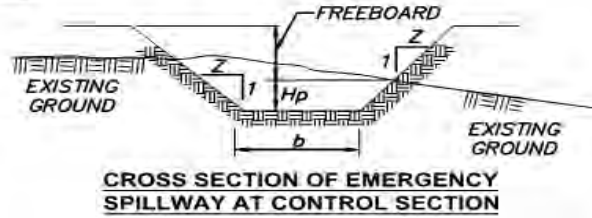
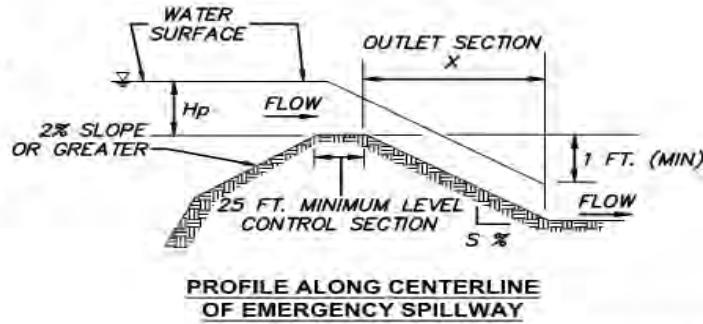
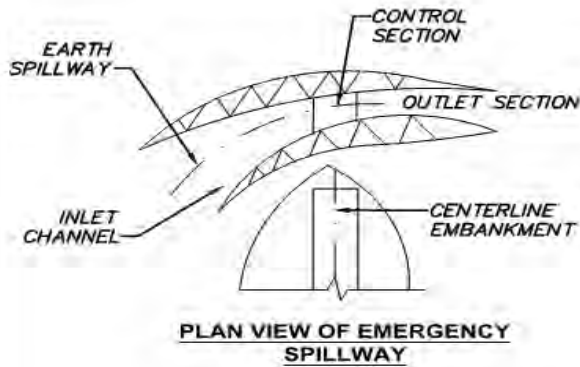

**LEGEND**

- $n$  = MANNING'S COEFFICIENT OF ROUGHNESS
- $H_p$  = DIFFERENCE IN ELEVATION BETWEEN THE CREST OF THE EMERGENCY SPILLWAY AND THE CONTROL SECTION AND WATER SURFACE OF THE RESERVOIR, IN FEET.
- $b$  = BOTTOM WIDTH OF EMERGENCY SPILLWAY AT THE CONTROL SECTION, IN FEET. ( 8 FT. MINIMUM)
- $Q$  = TOTAL DISCHARGE, IN CFS
- $V$  = VELOCITY, IN FEET PER SECOND, THAT WILL EXIST IN THE CHANNEL BELOW THE CONTROL SECTION, AT DESIGN  $Q$ , IF CONSTRUCTED TO SLOPE ( $S$ ) THAT IS SHOWN. ( $V_{MAX} = 5FPS.$ )
- $S$  = FLATTEST SLOPE ( $S$ ), IN %, ALLOWABLE FOR THE CHANNEL BELOW THE CONTROL SECTION.
- $X$  = MINIMUM LENGTH OF THE CHANNEL BELOW THE CONTROL SECTION, IN FEET.
- $Z$  = SIDE SLOPE RATIO (MIN.  $Z=3$ )

**NOTE**

1. FOR A GIVEN  $H_p$  A DECREASE IN THE EXIT SLOPE FROM  $S$  AS GIVEN IN THE TABLE DECREASES THE SPILLWAY DISCHARGE BUT INCREASING THE EXIT SLOPE FROM  $S$  DOES NOT INCREASE THE DISCHARGE. IF AN EXIT SLOPE ( $S_e$ ) STEEPER THAN  $S$  IS USED, THEN THE VELOCITY ( $V_e$ ) IN THE EXIT CHANNEL WILL INCREASE ACCORDING TO THE FOLLOWING RELATIONSHIP:

$$V_e = V \left( \frac{S_e 0.3}{S} \right)$$

DATE	APPR	
REVISED		
ISSUED:		
	REFERENCE	

**EMERGENCY SPILLWAY  
SEDIMENT BASIN**

★ ★ ★ DISTRICT OF COLUMBIA  
DEPARTMENT OF ENERGY &  
ENVIRONMENT

DWG. NO 602.5

(SOURCE) 2011 MARYLAND STANDARDS & SPECIFICATIONS

Detail 48 – 602.5 Emergency Spillway



# Chapter 7 Dewatering

## 7.1 Removable Pumping Station

### 7.1.1 Definition

An easily maintained temporary structure which is used to remove water from excavated areas, and sediment traps and basins.

### 7.1.2 Purpose

To filter sediment-laden water at a pump intake, prior to discharging to a suitable area.

### 7.1.3 Conditions Where Practice Applies

Removable pumping stations are constructed where water collects and must be pumped away during excavation, cofferdam dewatering, maintenance or removal of sediment traps and basins, or for other uses as applicable. These are preferred over sump pits on projects when a long duration of pumping is expected.

Note: Any discharge to combined sewers requires a Temporary Discharge Authorization Permit from DC Water. Any discharge to the District MS4 or to a surface waterbody from an eligible project, as regulated by the Construction General Permit (CGP), requires a Notice of Intent (NOI) submitted to EPA. Once determined that the project has stormwater runoff that must be discharged on a temporary basis, contact DC Water or EPA for permit information.

### 7.1.4 Design Criteria

Determine the number of removable pumping stations and their locations by the designer and include on the plans. Contractors may relocate sump pits to optimize use but discharge location changes must be coordinated with inspectors. A design is not required but construction must conform to the general criteria outlined in Detail 701.1.

Construction of a removable pumping station may require application for a well construction building permit issued by DCRA. A permit is not required if all the following conditions are met:

- The removable pumping station pit has a depth of less than 10 feet, measured from the bottom of excavation,
- The bottom of the removable pumping station is above the seasonal water table, and
- The removable pumping station is more than 25 feet away from District surface waters or wetlands.

If any of these conditions are not met, then a well construction building permit and a well construction work plan is required per the District's Municipal Code (21 DCMR §§ 1801–1803).

Place a perforated, vertical standpipe wrapped with wire mesh and geotextile inside a larger pipe. Envelope the outside pipe by a cone of washed stone. Pump water from the center of the inside pipe to a suitable discharge area, such as sediment trap, sediment basin, or stabilized area.

#### Inner Pipe

Construct the inner pipe by perforating a 12-inch to 36-inch diameter corrugated metal or plastic pipe with a watertight cap on the bottom end. The perforations must be ½-inch by 6-inch slits or 1-inch diameter holes 6 inches on center.

#### Geotextile

The geotextile must be Geotextile Class E.

#### Outer Pipe

Construct the outer pipe by perforating an 18-inch to 42-inch diameter corrugated metal or plastic pipe. It must be at least 6 inches larger in diameter than the inside pipe and be capped with a watertight seal. The perforations must be ½-inch by 6-inch slits or 1-inch diameter holes 6 inches on center.

#### Filter Material

Backfill filter material ranging from clean gravel (minimal fines) to #57 stone (1½-inch maximum diameter) around the outer pipe.

### **7.1.5 Construction Specifications**

1. Wrap the inner pipe with ¼-inch hardware cloth and then geotextile over the hardware cloth. Wrap the outer pipe with ¼-inch hardware cloth.
2. Excavate 8 feet by 8 feet by 4 feet deep pit for pipe placement. Place clean ¾ -inch to 1½-inch stone or equivalent recycled concrete, 6 inches in depth prior to pipe placement.
3. Both the inner and outer pipes must extend a minimum of 12 inches above the anticipated water surface elevation (or riser crest elevation when dewatering a basin).
4. Backfill pit around the outer pipe with ¾-inch to 1½-inch clean stone or equivalent recycled concrete and extend stone a minimum of 6 inches above anticipated water surface elevation.
5. Place the suction hose from the pump inside the inner pipe to begin dewatering. Place the discharge hose in a stabilized area downslope of unstabilized areas to prevent erosion. Meadow or wooded areas are preferred discharge locations but storm drains and paved areas are acceptable.

### **7.1.6 Maintenance**

The removable pumping station requires frequent maintenance. If the system clogs, remove the inner pipe to replace the geotextile. Maintenance must be performed when the pump runs dry and backed up water remains. The point of discharge must be kept free of erosion.

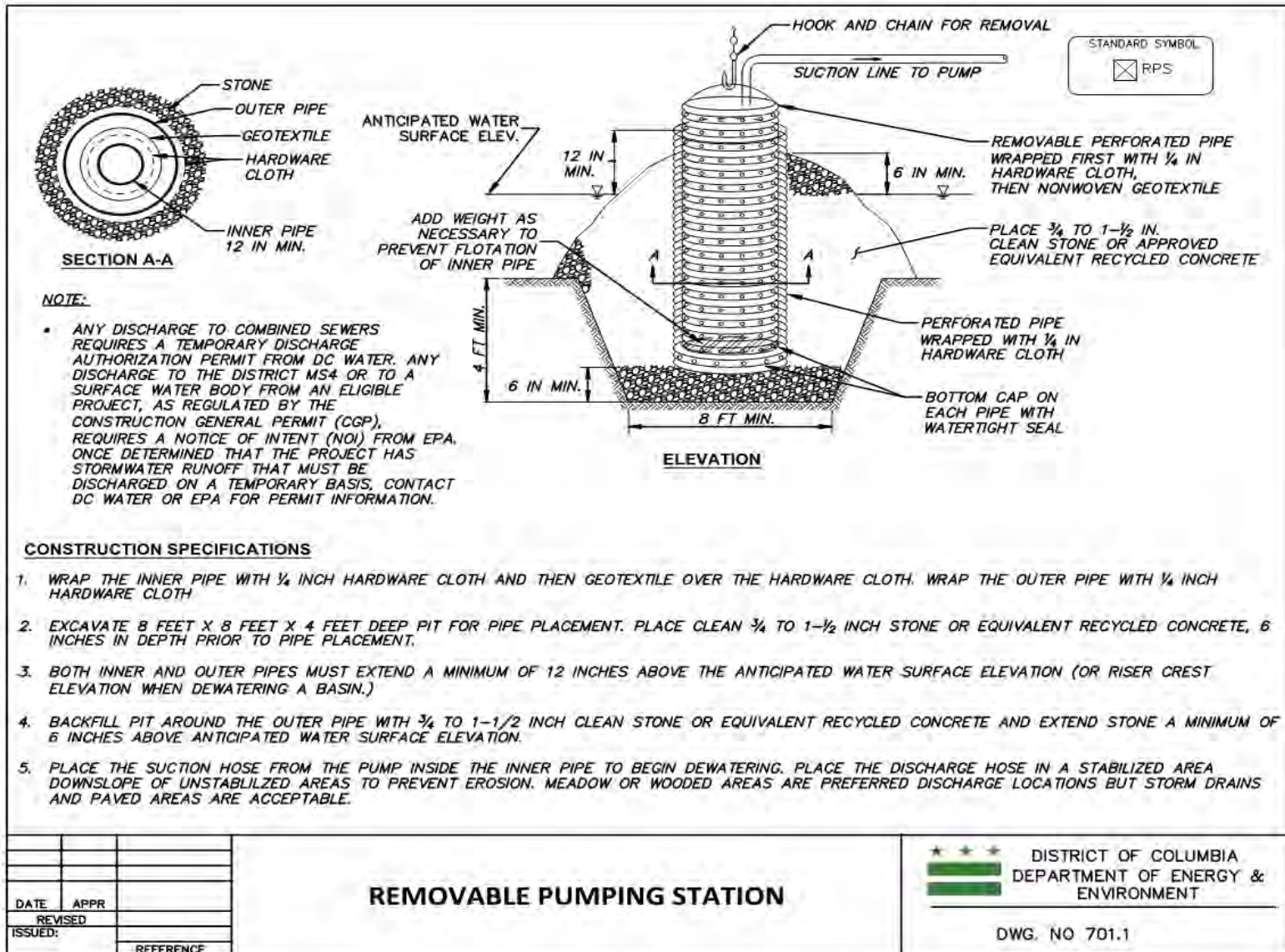

SOURCE: 2011 MARYLAND STANDARDS AND SPECIFICATIONS

Detail 49 – 701.1 Removable Pumping Station

---

## 7.2 Sump Pit

### 7.2.1 Definition

A temporary pit to pump and remove excess water while minimizing sedimentation.

### 7.2.2 Purpose

To filter sediment-laden water at a pump intake, prior to discharging to a suitable area.

### 7.2.3 Conditions Where Practice Applies

When dewatering is needed for a short duration (i.e., less than 3 months) during excavating, cofferdam dewatering, maintenance or removal of sediment traps and basins, or other uses as applicable.

Note: Any discharge to combined sewers requires a Temporary Discharge Authorization Permit from DC Water. Any discharge to the District MS4 or to a surface waterbody from an eligible project, as regulated by the Construction General Permit (CGP), requires a Notice of Intent (NOI) submitted to EPA. Once determined that the project has stormwater runoff that must be discharged on a temporary basis, contact DC Water or EPA for permit information.

### 7.2.4 Design Criteria

Determine the number of sump pits and their locations by the designer and include on the plans. Contractors may relocate sump pits to optimize use but discharge location changes must be coordinated with inspectors. A design is not required but construction must conform to the general criteria outlined on Detail 702.1.

Construction of a sump pit may require application for a well construction building permit issued by DCRA. A permit is not required if all the following conditions are met:

- The sump pit has a depth of less than 10 feet, measured from the bottom of excavation,
- The bottom of the sump pit is above the seasonal water table, and
- The sump pit is more than 25 feet away from District surface waters or wetlands.

If any of these conditions are not met, then a well construction building permit and a well construction work plan is required per the District's Municipal Code (21 DCMR §§ 1801–1803).

Place a perforated, vertical standpipe wrapped with wire mesh and geotextile in the center of an excavated pit and then backfill with stone or gravel. Then pump water from the center of the standpipe to a suitable discharge area, such as a sediment trap, sediment basin, or stabilized area.

#### Standpipe

Construct the standpipe by perforating a 12-inch or larger diameter corrugated metal or plastic pipe with a watertight cap on the bottom end. The perforations must be ½-inch by 6-inch slits or 1-inch diameter holes 6 inches on center.

### Geotextile

The geotextile must be Geotextile Class E.

### Filter Material

Backfill filter material ranging from clean gravel (minimal fines) to #57 stone (1½-inch maximum diameter) around the outer pipe.

## **7.2.5 Construction Specifications**

1. Wrap the pipe with ¼-inch galvanized hardware cloth and then geotextile over the hardware cloth.
2. Excavate the pit to 3 times the pipe diameter and 4 feet in depth. Place clean ¾-inch to 1½-inch stone or equivalent recycled concrete, 6 inches in depth prior to pipe placement.
3. Set the top of pipe a minimum of 12 inches above the anticipated water surface elevation.
4. Backfill pit around the outer pipe with ¾-inch to 1½-inch clean stone or equivalent recycled concrete and extend stone a minimum of 6 inches above anticipated water surface elevation.
5. Place the suction hose from the pump inside the pipe to begin dewatering. Place the discharge hose in a stabilized area downslope of unstabilized areas to prevent erosion. Meadow or wooded areas are preferred discharge locations but storm drains and paved areas are acceptable.

## **7.2.6 Maintenance**

The sump pit requires frequent maintenance. If the system clogs, the perforated pipe must be removed and the geotextile and stone replaced. The point of discharge must be kept free of erosion.



STANDARD SYMBOL  
 SF

SET TOP OF PIPE  
 MIN. OF 12 IN ABOVE  
 ANTICIPATED HIGHWATER  
 LEVEL

SUCTION LINE TO PUMP

6 IN MIN.

STANDPIPE WRAPPED  
 IN ¼ IN. HARDWARE CLOTH,  
 THEN NONWOVEN GEOTEXTILE

SIDE SLOPE  
 (VARIES)

12 IN MIN. DIAMETER  
 PERFORATED CORRUGATED  
 METAL, HDPE, OR PVC PIPE

CLEAN STONE OR EQUIVALENT RECYCLED  
 CONCRETE ¾ TO 1-½ IN.

6 IN BASE OF STONE  
 BELOW STANDPIPE

MIN. 3 x PIPE  
 DIAMETER

CAP OR PLATE  
 WITH WATERTIGHT  
 CONNECTION

ELEVATION

**NOTE:**

• ANY DISCHARGE TO COMBINED SEWERS  
 REQUIRES A TEMPORARY DISCHARGE  
 AUTHORIZATION PERMIT FROM DC  
 WATER. ANY DISCHARGE TO THE  
 DISTRICT MS4 OR TO A SURFACE  
 WATER BODY FROM AN ELIGIBLE  
 PROJECT, AS REGULATED BY THE  
 CONSTRUCTION GENERAL PERMIT (CGP),  
 REQUIRES A NOTICE OF INTENT (NOI)  
 FROM EPA. ONCE DETERMINED THAT  
 THE PROJECT HAS STORMWATER  
 RUNOFF THAT MUST BE DISCHARGED  
 ON A TEMPORARY BASIS, CONTACT DC  
 WATER OR EPA FOR PERMIT  
 INFORMATION.

**CONSTRUCTION SPECIFICATIONS**

1. WRAP THE PIPE WITH ¼ INCH GALVANIZED HARDWARE CLOTH AND THEN GEOTEXTILE OVER THE HARDWARE CLOTH.
2. EXCAVATE THE PIT TO 3 TIMES THE PIPE DIAMETER AND 4 FEET IN DEPTH. PLACE CLEAN ¾ TO 1-½ INCH STONE OR EQUIVALENT RECYCLED CONCRETE, 6 INCHES IN DEPTH PRIOR TO PIPE PLACEMENT.
3. SET THE TOP OF PIPE A MINIMUM OF 12 INCHES ABOVE THE ANTICIPATED WATER SURFACE ELEVATION.
4. BACKFILL PIT AROUND THE OUTER PIPE WITH ¾ TO 1-½ INCH CLEAN STONE OR EQUIVALENT RECYCLED CONCRETE AND EXTEND STONE A MINIMUM OF 6 INCHES ABOVE ANTICIPATED WATER SURFACE ELEVATION.
5. PLACE THE SUCTION HOSE FROM THE PUMP INSIDE THE PIPE TO BEGIN DEWATERING. PLACE THE DISCHARGE HOSE IN A STABILIZED AREA DOWNSLOPE OF UNSTABILIZED AREAS TO PREVENT EROSION. MEADOW OR WOODED AREAS ARE PREFERRED DISCHARGE LOCATIONS BUT STORM DRAINS AND PAVED AREAS ARE ACCEPTABLE.

DATE	APPR	
REVISED		
ISSUED:		
	REFERENCE	

**SUMP PIT**

\*\*\* DISTRICT OF COLUMBIA  
 DEPARTMENT OF ENERGY &  
 ENVIRONMENT

DWG. NO 702.1

(SOURCE) 2011 MARYLAND STANDARDS AND SPECIFICATIONS

Detail 50 – 702.1 Sump Pit

## 7.3 Portable Sediment Tank

### 7.3.1 Definition

A portable sediment tank is a compartmented container through which sediment-laden water is pumped in order to trap and retain the sediment.

### 7.3.2 Purpose

To trap and retain sediment prior to pumping the water to drainage ways, adjoining properties, and rights-of-way below the sediment tank site.

### 7.3.3 Conditions Where Practice Applies

Use a portable sediment tank on sites where excavations are deep and space is limited, such as urban construction, to avoid direct discharge of sediment-laden water to stream and storm drainage systems.

Note: Any discharge to combined sewers requires a Temporary Discharge Authorization Permit from DC Water. Any discharge to the District MS4 or to a surface waterbody from an eligible project, as regulated by the Construction General Permit (CGP), requires a Notice of Intent (NOI) submitted to EPA. Once determined that the project has stormwater runoff that must be discharged on a temporary basis, contact DC Water or EPA for permit information.

### 7.3.4 Design Criteria

A portable sediment tank must be sized and operated to allow pumped water to flow through the filtering device without overtopping the structure. Tanks may be connected in series. Any geotextile required must be Geotextile Class E.

Use the following formula to determine the minimum storage volume of the portable sediment tank:

$$\text{Pump discharge (gpm)} \times 16 = \text{cubic feet of storage required}$$

Additional storage may be needed to ensure that the water discharging from the tanks is clear. Locate the portable sediment tank for ease of clean-out and disposal of the trapped sediment and to minimize interference with construction activities and pedestrian traffic.

### 7.3.5 Construction Specifications

#### Portable Sediment Tank - Horizontal (see Detail 703.1)

1. Construct the structure with steel drums, sturdy wood, or other material suitable for handling the pressure exerted by the volume of water.
2. Sediment tanks have a minimum depth of 2 feet.
3. Once the water level nears the top of the tank, shut off the pump while the tank drains and additional capacity is made available.

4. Design the tank to allow for emergency flow over top of the tank.

Portable Sediment Tank - Vertical (see Detail 703.2)

1. Use 60-inch corrugated metal or plastic pipe with 1-inch diameter perforations, 6 inches on center for the inner pipe. Line pipe with nonwoven geotextile sandwiched between, and attached to, ¼-inch hardware cloth.
2. Overlap geotextile 8 inches minimum at vertical seam and at the bottom plate.
3. Anchor geotextile at bottom of tank with 4 inches of 2-inch to 3-inch clean stone or equivalent recycled concrete.
4. Use 72-inch corrugated metal or plastic outer pipe with permanent outflow pipe with invert lower than inflow pipe.
5. Inflow pipe must discharge into inner pipe and be removable.
6. Place tank on level surface and discharge to a stable area at a non-erosive rate.

### **7.3.6 Maintenance**

Inspect the filtering devices frequently and repair or replace once the sediment build-up prevents the structure from functioning as designed. For the horizontal tank, clean-out is required once one-third of the original capacity is depleted due to sediment accumulation. The tank must be clearly marked showing the clean-out point. For the vertical tank, remove accumulated sediment from the inner pipe when it reaches 2 feet in depth. If the system clogs, pull out the inner pipe, remove the accumulated sediment, and replace the geotextile. Keep the discharge point free of erosion.

The accumulated sediment which is removed from a dewatering device must be spread on-site and stabilized or disposed of at an approved disposal site as per approved plan.

STANDARD SYMBOL  
 PST

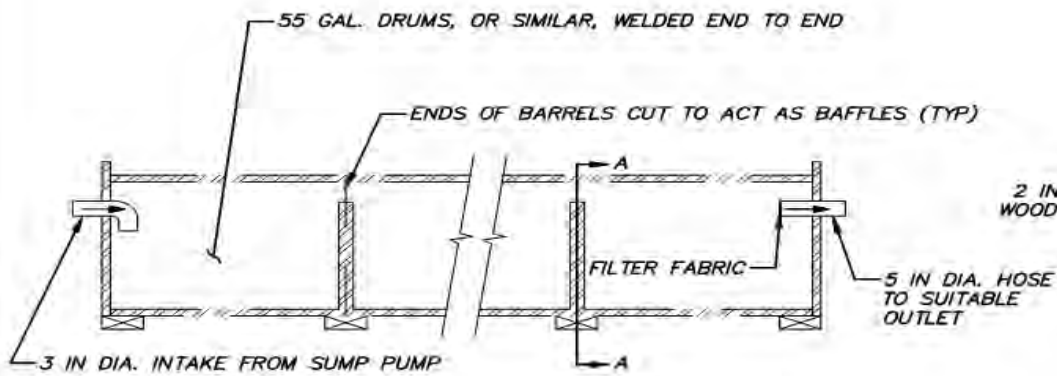

**ELEVATION**

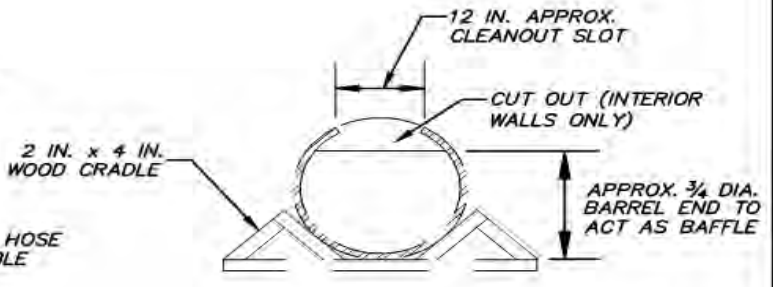

**SECTION A-A**

**CONSTRUCTION SPECIFICATIONS**

1. CONSTRUCT THE STRUCTURE WITH STEEL DRUMS, STURDY WOOD, OR OTHER MATERIAL SUITABLE FOR HANDLING THE PRESSURE EXERTED BY THE VOLUME OF WATER.
2. SEDIMENT TANKS HAVE A MINIMUM DEPTH OF 2 FEET.
3. ONCE THE WATER LEVEL NEARS THE TOP OF THE TANK, SHUT OFF THE PUMP WHILE THE TANK DRAINS AND ADDITIONAL CAPACITY IS MADE AVAILABLE.
4. DESIGN THE TANK TO ALLOW FOR EMERGENCY FLOW OVER TOP OF THE TANK.

DATE	APPR	
REVISED		
ISSUED:		
		REFERENCE

**PORTABLE SEDIMENT TANK - 1  
(HORIZONTAL)**

\*\*\* DISTRICT OF COLUMBIA  
 DEPARTMENT OF ENERGY &  
 ENVIRONMENT

DWG. NO 703.1

SOURCE: USDA-NRCS

Detail 51 – 703.1 Portable Sediment Tank (Horizontal)

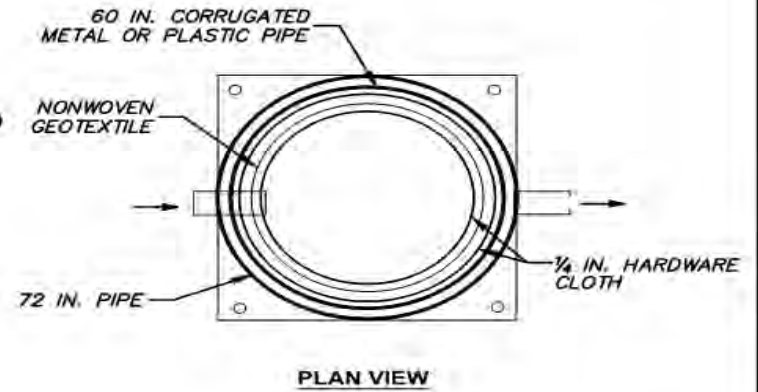
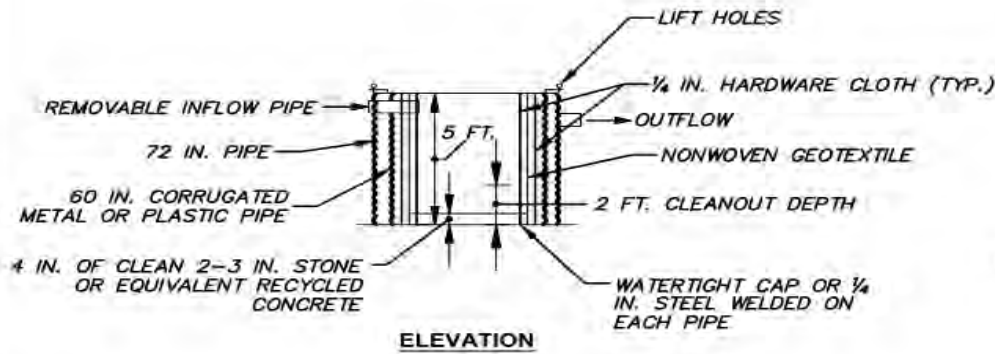

**CONSTRUCTION SPECIFICATIONS**

1. USE 60 INCH CORRUGATED METAL OR PLASTIC PIPE WITH 1 INCH DIAMETER PERFORATIONS, 6 INCHES ON CENTER FOR THE INNER PIPE. LINE PIPE WITH NONWOVEN GEOTEXTILE SANDWICHED BETWEEN, AND ATTACHED TO, 1/4 INCH HARDWARE CLOTH.
2. OVERLAP GEOTEXTILE 8 INCHES MINIMUM AT VERTICAL SEAM AND AT THE BOTTOM PLATE.
3. ANCHOR GEOTEXTILE AT BOTTOM OF TANK WITH 4 INCHES OF 2 TO 3 INCH CLEAN STONE OR EQUIVALENT RECYCLED CONCRETE.
4. USE 72 INCH CORRUGATED METAL OR PLASTIC OUTER PIPE WITH PERMANENT OUTFLOW PIPE WITH INVERT LOWER THAN INFLOW PIPE.
5. INFLOW PIPE MUST DISCHARGE INTO INNER PIPE AND BE REMOVABLE.
6. PLACE TANK ON LEVEL SURFACE AND DISCHARGE TO A STABLE AREA AT A NON-EROSIVE RATE.

DATE	APPR	
REVISED		
ISSUED:		
	REFERENCE	

**PORTABLE SEDIMENT TANK - 2  
(VERTICAL)**



DISTRICT OF COLUMBIA  
DEPARTMENT OF ENERGY &  
ENVIRONMENT

DWG. NO 703.2

SOURCE: 2011 MARYLAND STANDARDS AND SPECIFICATIONS

Detail 52 – 703.2 Portable Sediment Tank (Vertical)

## **7.4 Pumped Water Filter Bags**

### **7.4.1 Definition**

A geotextile bag through which sediment-laden water is pumped.

### **7.4.2 Purpose**

To filter sediment-laden water prior to discharge off-site.

### **7.4.3 Conditions Where Practice Applies**

Filter bags may be used to filter, settle, or chemically flocculate sediments from water pumped from disturbed areas prior to discharging to waters of the District. Such areas include excavations, trenches, and the sediment storage areas of cofferdams and sediment traps or basins. Where fine clay soils are present in stormwater runoff, chemical treatment with flocculants, as described in specification Section 9.4 Flocculants, may be necessary.

Note: Any discharge to combined sewers requires a Temporary Discharge Authorization Permit from DC Water. Any discharge to the District MS4 or to a surface waterbody from an eligible project, as regulated by the Construction General Permit (CGP), requires a Notice of Intent (NOI) submitted to EPA. Once determined that the project has stormwater runoff that must be discharged on a temporary basis, contact DC Water or EPA for permit information.

### **7.4.4 Design Criteria**

#### Pumping Rate

Specify the pumping rate on the plan drawings next to the typical detail. The maximum pumping rate for any bag in use or proposed for use on a site should be available at the site at all times during pumping operations. Pumping rates will vary depending on the size of the filter bag and the type and amount of sediment discharged to the bag.

#### Material

Use nonwoven geotextile with double stitched seams using high strength thread. Size sleeve to accommodate a maximum 4-inch diameter pump discharge hose. The bag must be manufactured from a nonwoven geotextile that meets or exceeds minimum average roll values for the criteria specified in Table 7.1.



**Table 7.1 Filter Bag Geotextile Criteria**

Physical Properties	Minimum Values	ASTM Test Method
Grab tensile	250 lb	ASTM D-4632
Puncture	150 lb	ASTM D-4833
Flow rate	70 gal/min/ft <sup>3</sup>	ASTM D-4491
Permittivity (sec <sup>-1</sup> )	1.2 sec <sup>-1</sup>	ASTM D-4491
UV Resistance	70% strength @ 500 hours	ASTM D-4355
Apparent Opening Size (AOS)	0.15–0.18 mm	ASTM D-4751
Seam Strength	90%	ASTM D-4632

### Location

Locate the bags in well-vegetated (grassy) area, and discharge onto stable, erosion resistant areas. Where this is not possible, place the bags on 8 inches of suitable base such as mulch, leaf/wood compost, woodchips, sand, or straw bales. Extend the base a minimum of 12 inches from the edges of the bag. Do not place the bags on slopes greater than 5%. Provide a suitable means of accessing the bag with machinery required for disposal purposes.

### Discharge Hose

Insert the pump discharge hose into the bags in the manner specified by the manufacturer and securely clamp. It must remain watertight during operation.

### **7.4.5 Construction Specifications**

1. Tightly seal sleeve around the pump discharge hose with a strap or similar device.
2. Place filter bag on 8 inches suitable base located on a level or 5% maximum sloping surface, and discharge to a stabilized area. Extend base a minimum of 12 inches from the edges of the bag.
3. Control pumping rate to prevent excessive pressure within the filter bag in accordance with the manufacturer recommendations. As the bag fills with sediment, reduce pumping rate.
4. Remove and properly dispose of filter bag upon completion of pumping operations or after bag has reached capacity, whichever occurs first. Spread the dewatered sediment from the bag in an approved upland area and stabilize with seed and mulch by the end of the work day. Restore the surface area beneath the bag to original condition upon removal of the device.

#### **7.4.6 Maintenance**

Inspect filter bags daily. Replace clogged filter bags. If any problem is detected, such as rips, tears, or punctures in the filter bag, pumping must cease immediately and not resume until the problem is corrected or bag is replaced. Replace displaced bedding.



STANDARD SYMBOL  
 FB

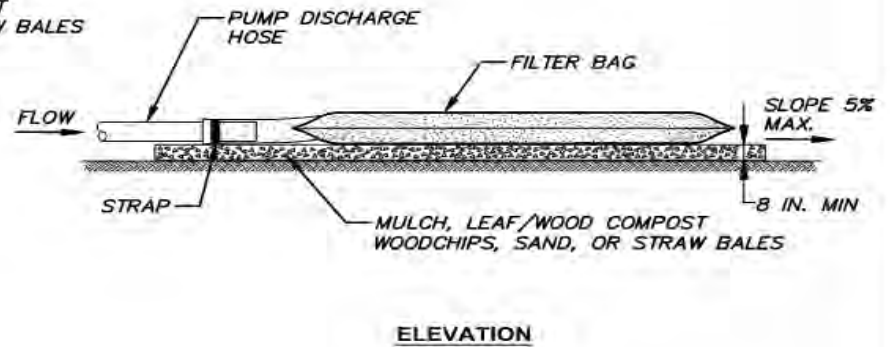
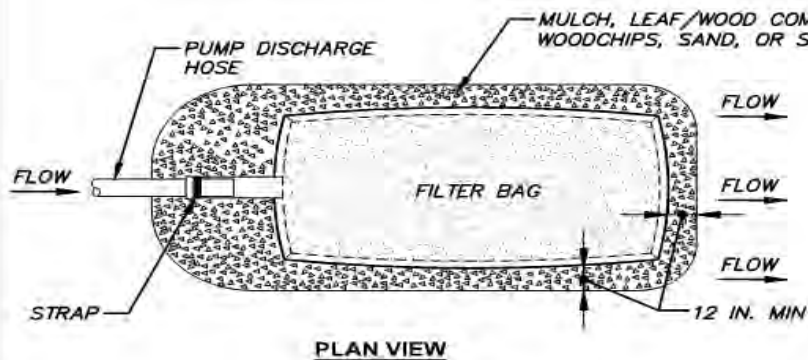

**CONSTRUCTION SPECIFICATIONS**

1. TIGHTLY SEAL SLEEVE AROUND THE PUMP DISCHARGE HOSE WITH A STRAP OR SIMILAR DEVICE.
2. PLACE FILTER BAG ON 8 INCHES SUITABLE BASE LOCATED ON A LEVEL OR 5% MAXIMUM SLOPING SURFACE. AND DISCHARGE TO A STABILIZED AREA. EXTEND BASE A MINIMUM OF 12 INCHES FROM EDGES OF BAG.
3. CONTROL PUMPING RATE TO PREVENT EXCESSIVE PRESSURE WITHIN THE FILTER BAG IN ACCORDANCE WITH THE MANUFACTURER RECOMMENDATIONS. AS THE BAG FILLS WITH SEDIMENT, REDUCE PUMPING RATE.
4. REMOVE AND PROPERLY DISPOSE OF FILTER BAG UPON COMPLETION OF PUMPING OPERATIONS OR AFTER BAG HAS REACHED CAPACITY, WHICHEVER OCCURS FIRST. SPREAD THE DEWATERED SEDIMENT FROM THE BAG IN AN APPROVED UPLAND AREA AND STABILIZE WITH SEED AND MULCH BY THE END OF THE WORK DAY. RESTORE THE SURFACE AREA BENEATH THE BAG TO ORIGINAL CONDITION UPON REMOVAL OF THE DEVICE.

DATE	APPR
REVISED	
ISSUED:	
	REFERENCE

**PUMPED WATER FILTER BAGS**

★ ★ ★ DISTRICT OF COLUMBIA  
 DEPARTMENT OF ENERGY &  
 ENVIRONMENT

DWG. NO 704.1

SOURCE: 2011 MARYLAND STANDARDS AND SPECIFICATIONS

Detail 53 – 704.1 Pumped Water Filter Bags



# Chapter 8 Waterways and Stream Protection

## 8.1 Stream Protection Preface

### 8.1.1 Foreword

Streams are an important landscape feature that requires specific consideration when planning and implementing work in and around them. This section describes best management practices and strategies that should be undertaken to protect these sensitive features during construction activities. Previous editions of the Erosion and Sediment Control Manual included specific practices used for the stabilization or restoration of streams. These practices have been removed in this edition to reduce regulatory overlap and inconsistency with the evolving practice and science of stream stabilization and restoration.

Streams are protected under federal and District laws or regulations. Working in areas will require the coordination with additional regulatory authorities including the Baltimore District of the U.S. Army Corps of Engineers (USACE), the Federal Emergency Management Agency (FEMA), and U.S. Fish and Wildlife Service (USFWS). Any work occurring within or adjacent to streams must adhere to all applicable permit requirements and conditions. Section 401 of the Clean Water Act requires that any applicant for USACE permits must also obtain a certification from the District for any work in navigable waters (on, in, or above the waters), or for discharge (dump, place, deposit) of dredged or fill materials, including impacts to wetlands. If USACE determines that the wetland is not within its jurisdictional waters, the applicant must obtain a District Wetland Permit for projects in the District. Conformance with the strategies and specifications within this section should not be interpreted to supersede or replace the necessity to comply with other permit requirements or conditions.

This Manual outlines stream protection practices that are employed to reduce erosion and sedimentation from construction activities. Although the stabilization or restoration of streams were previously thought to fall within this scope, these activities are now considered to be a specialized form of ecological intervention that aim to improve or restore the natural function of stream corridors (Harman et al., 2012). The term, stream restoration, describes a variety of practices that generally seeks to improve geomorphic and/or ecologic function, structure, and integrity of river corridors (Bennett et al., 2011). Over the past three decades the practice has evolved considerably from restoration primarily undertaken for recreational or aesthetic purposes to more comprehensive restoration focused on restoring multiple ecological functions (Wohl & Wilcox, 2015). Numerous design methodologies and guidance documents have been published to aid practitioners in developing appropriate stream restoration plans. Ongoing research in applied water-resources science continues to expand the understanding of these complex systems. Presently, the practice of stream restoration remains highly controversial due to the lack of scientific evidence demonstrating “success” (Palmer et al. 2014). However, stream restoration continues to be employed by watershed managers and others to address a wide range of objectives.

Regional efforts within the Chesapeake Bay watershed estimate that 655 miles of stream restoration are anticipated by the year 2025 with approximately 8 miles occurring within the District of Columbia as part of the Phase 2 Watershed Implementation Plan (WIP) (Schueler, Stack, 2014). With these and other ongoing efforts, stream restoration has become a multibillion dollar industry worldwide (Bennett et al., 2011). The evolving science and expanding practice of stream restoration as well as the breadth of the subject matter make it impractical to address in a comprehensive manner within this document. Instead, this chapter focuses on the measures that may be implemented to reduce the erosion and sedimentation during construction, rather than from ongoing fluvial or watershed processes.

Since stream restoration practices require specialized construction, the following introduction provides a general overview of concepts as they relate to erosion and sediment control as well as references to more comprehensive design guidance currently available.

### **8.1.2 Introduction**

The intent of these standards and specifications is to provide guidance for the installation of practices that will reduce erosion and sedimentation while conducting construction activities in and around streams. Construction activities in stream corridors may be necessary for a variety of reasons including the development of utility lines, road construction, heavy equipment crossings for construction access, stream stabilization, and stream restoration projects. Conformance with this section should not be interpreted to supersede or replace the necessity to comply with other permit requirements or conditions that may be necessary for work within stream corridors.

This section does not intend to provide guidance for comprehensive stream stabilization and restoration activities; however, a general review of restoration concepts as they relate to erosion and sediment control has been provided (see “General Guidance for Stream Restoration Projects”). Additional stream restoration design resources are also provided should the reader need more specific guidance during the development or review of erosion and sediment control plans (see “Stream Restoration Design Manuals”).

#### Working in and Adjacent to Streams

As mentioned elsewhere in this manual, areas of significant natural resource value such as streams must be protected during the construction process. When construction in and adjacent to streams is necessary, it may not be possible or practical to adhere to all the erosion and sediment control guidelines typical for upland construction activities. In these cases, it is important to follow a methodology that will limit sedimentation and impact to natural resources. In general, the process for limiting sedimentation and erosion is to minimize disturbance, install protection measures, sequence construction, divert runoff or stream flow, and install structural control practices.

During construction, limit disturbance to the minimum time and area required for implementation of the proposed activity. Mark the limits of disturbance using flagging or safety fence to reduce inadvertent damage to riparian habitat. Limit the removal of existing vegetation to the extent practicable. Additional control measures including but not limited to tree protection and silt fence should be used as necessary to protect adjacent resources.

It is recommended to phase clearing activities in conjunction with construction activities (Clinton, Jennings, McLaughlin & Bidelspach, 2004). Phasing disturbance results in fewer chances that storm events will cause sediment discharges to streams. Minimize access roads and stockpile areas and coordinate with construction activities. Protect these areas from stormwater runoff through the use of structural control practices as indicated in their respective standard and specification. Remove structural control practices and stabilize the areas when they are no longer in use.

When in-channel construction must occur, limit the work area to that necessary for implementing the intended construction activity. If diversions are to be used, limit the work area and duration of construction to an area that will be under continuous daily construction. Remove diversions and stream crossings after they are no longer needed or construction activity has moved elsewhere. Establish a construction sequence to limit the number of times heavy machinery enters and exits the site. By describing this sequence of activities clearly within an erosion and sediment control plan, erosion and sedimentation can be minimized within stream corridors.

#### General Guidance for Stream Restoration Projects

Stream restoration and stabilization projects require the use of heavy machinery along and sometimes within stream channels. This generates the need for implementing erosion and sediment control strategies and best management practices to protect downstream and riparian resources. The same practices used for erosion and sediment control during work for other types of projects should be used for stream restoration projects. In addition to these items, give special consideration to the sequence of construction, the use of diversions, and the clearing and stockpiling of materials.

Limit stream construction activity to no more area than can be constructed and stabilized in one working day. Complete each stream section before moving on to the next section. Typically work proceeds from upstream to downstream. This minimizes soil loss and erosion potential and prevents subsequent activities from affecting completed work. Protect soil stockpiles with silt fence and install per the construction plans. As a rule of thumb, approximately 500 feet of stream construction can be installed and stabilized in one working day. However, this length can vary depending on the size of stream and project complexity.

Operate construction equipment outside the stream top of bank where feasible. In cases where construction from the stream bank is infeasible or impractical and construction equipment will be required to work within the active channel, all measures must be implemented to control sedimentation and contamination to the stream. These measures include, but are not limited to, temporary platforms, in channel diversions, and portable dams. Install all construction stabilization measures in strict accordance with an approved restoration plan and accompany with any and all necessary design calculations.

#### Stream Restoration Design Manuals

Stream restoration design is highly specialized and should be undertaken by qualified professionals including water-resources engineers, fluvial geomorphologists, biologists, and ecologists. The following list of references documents a selection of currently available, comprehensive stream restoration design manuals. It is not intended to be a comprehensive

literature review of the science and practice of stream stabilization and restoration. Rather it serves as a repository of many years of knowledge on the art and science of stream restoration design.

- National Engineering Handbook 653: Stream Corridor Restoration: Principles, Processes, and Practices (FISRWG, 1998)
- National Engineering Handbook 654: Stream Restoration Design (NRCS, 2007)
- Hydraulic Design of Stream Restoration Projects (Copeland, et. al., 2001)
- Channel Restoration Design for Meandering Rivers (Soar and Thorne, 2001)
- Science Base and Tools for Evaluating Stream Engineering, Management, and Restoration Proposals (Skidmore, et. al., 2011)
- A Natural Channel Design Handbook, North Carolina (Doll, et. al., 2003)
- Guidelines for Naturalized River Channel Design and Bank Stabilization, New Hampshire (Schiff, et. al., 2007)
- The Virginia Stream Restoration & Stabilization Best Management Practices Guide (Virginia DCR, 2004)
- Maryland's Waterway Construction Guidelines (MDE, 2000)
- Stream Habitat Restoration Guidelines, Washington State (Cramer, 2012)
- Guidelines for Streambank Restoration, Georgia (GSWCC, 2000)
- Applied River Morphology (Rosgen, 1996)

#### Stream Restoration Project Review

Stream restoration project review should be conducted by qualified and knowledgeable professionals. Plan and design projects under a recognized functional framework to ensure that projects attain physical, chemical, and biological improvements. EPA's "Function-Based Framework for Stream Assessment & Restoration Projects" provides guidance on how to identify realistic goals and outcomes for stream restoration projects using a function based approach. Many federal and state agencies have developed and adopted robust processes for project reviews. Examples include the River Restoration Analysis Tool (RiverRAT) developed for NOAA and the USFWS, and the USFWS Chesapeake Bay Field Office Natural Channel Design checklist. Additionally, review the Compensatory Mitigation for Losses of Aquatic Resource rule, issued jointly by the EPA and USACE in 2008, when compensatory mitigation is required to offset impacts to streams. While not an exhaustive list, these guidance documents provide a framework for the approach to properly review many stream restoration projects.

#### Installation of Structures under Wave and/or Tidal Action

The installation of riprap, gabions, or deflectors under significant wave action or under tidal conditions requires special design considerations to ensure stability of the measure and the area it protects. The design/installation of these measures for tidal areas is beyond the scope of the District's Erosion and Sediment Control Law and Erosion and Sediment Control Regulations. DOEE and USACE can be consulted regarding minimum design parameters for tidal

installations. For situations where there is significant wave action affecting the shoreline of a nontidal lake or pond, use the design parameters presented in Chapter 4 Conveyance and Chapter 5 Water Control. Notably, there are many other site specific factors which should be incorporated into a design; hence, it is recommended that the design parameters presented here only be used as minimum requirements and that a qualified professional be consulted when the installation of such a structure is contemplated.

## **8.2 Temporary Access Stream Crossings**

### **8.2.1 Definition**

Temporary structure placed across a stream to provide access for construction purposes for a period of less than one year. Temporary access crossings must not be utilized to maintain traffic for the general public.

### **8.2.2 Purpose**

To prevent construction equipment from damaging the stream, blocking fish migration, and tracking sediment and other pollutants into the stream.

### **8.2.3 Conditions Where Practice Applies**

Use temporary access across a stream crossing if it is necessary for construction purposes. These standards and specifications may represent a channel constriction; thus, the temporary nature of stream access crossings must be stressed. They should be planned to be in service for the shortest practical amount of time and removed as soon as their function is completed. Strategic placement of crossings can reduce the number of crossings needed during construction. Culverts and access fords may not be appropriate for large streams or during high flow conditions. Consider alternative crossing methods such as a temporary bridge.

### **8.2.4 Design Criteria**

The following general design criteria apply. Consult the individual practice for more specific design criteria.

- Temporary crossings require coordination with regulatory agencies including USACE for a permit and DOEE for a Water Quality Certification.
- Temporary crossings can include different methods. Refer to specifications in Section 8.3 Temporary Access Ford, Section 8.4 Temporary Access Culvert, and Section 8.5 Temporary Access Bridge.
- Do not use earth or soil materials for construction within the stream channel.
- Design the crossing to have a minimum capacity sufficient to convey the stream's base flow for projects with duration of 2 weeks or less. For projects of longer duration, design the crossings to have a capacity sufficient to convey the 2-year flow without overtopping.
- Ensure that design flow velocity at the outlet of the crossing structure is non-erosive for the receiving stream channel and install outlet protection per Section 5.1 Rock Outlet Protection, as necessary.
- Use polyethylene geomembrane or other material that is impermeable and resistant to puncture and tearing.



### 8.2.5 Construction Specifications

The following are general guidelines. Consult the individual practice for more specific construction specifications.

1. All crossings have one traffic lane with a minimum width of 12 feet and a maximum width of 20 feet.
2. Limit in-stream excavation to only that necessary to allow installation and removal of the standard methods as presented in the individual practices (see Section 8.3 Access Ford, Section 8.4 Access Culvert, and Section 8.5 Access Bridge) and do not take place within the restricted time periods per approved permit as applicable.
3. Of the three basic methods presented in the individual practices section, bridges pose the least potential for creating barriers to aquatic migration. Do not construct any specific crossing method that causes a significant water level difference between the upstream and downstream water surface elevations.
4. Install the temporary stream crossing perpendicular to stream flow. Where approach conditions dictate, the crossing may vary 15 degrees from a line drawn perpendicular to the centerline of the stream at the intended crossing location.
5. Coincide the centerline of both roadway approaches with the crossing alignment centerline for a minimum distance of 50 feet from each bank of the stream being crossed. If physical or right-of-way restraints preclude the 50-foot minimum, a shorter distance may be provided. Limit all fill materials associated with the roadway approach to a maximum height of 2 feet above the existing floodplain elevation. To the extent possible, limit the work on the approaches primarily within the floodplain to grading to keep the road close to the existing grades.
6. Construct a water diverting structure such as a swale (across the roadway on both roadway approaches) 50 feet (maximum) on either side of the stream crossing. This will prevent roadway surface runoff from directly entering the stream. The 50 feet is measured from the top of the stream bank. Design criteria for this diverting structure is in accordance with the standards and specifications for the individual design standard of choice. If the roadway approach is constructed with a reverse grade away from the stream, a separate diverting structure is not required.

### 8.2.5 Maintenance

The standard methods will require various amounts of maintenance. The bridge method requires the least maintenance, whereas the ford method will probably require more intensive maintenance. For specific maintenance practices, refer to the maintenance sections for the individual practice.

For specific removal sequences, refer to the removal sections for the individual practice. In general, follow this sequence:

1. Inspect the site to determine the practice is no longer needed.

2. Remove all temporary crossings within 14 calendar days after the structure is no longer needed.
3. Remove sediment buildup (if applicable).
4. Remove the practice.
5. Revegetate the area disturbed by practice removal (if applicable).

## **8.3 Temporary Access Ford**

### **8.3.1 Definition**

Temporary shallow structure placed in the bottom of the stream over which the water flows while still allowing traffic to cross the stream.

### **8.3.2 Purpose**

To provide access for construction purposes for short periods of time. Temporary access crossings must not be utilized to maintain traffic for the general public.

### **8.3.3 Conditions Where Practice Applies**

A temporary access ford is appropriate if bridge or culvert crossings are not possible and the streambed is armored with naturally occurring bedrock, or can be protected with an aggregate layer conforming with these specifications. If in-stream access is necessary, fords can provide construction vehicle access to the streambed.

The practice must be in conformance with all applicable permits.

### **8.3.4 Design Criteria**

The following design criteria apply:

- Construct the approaches to the structure using stone pads. Cover the entire ford approach (where banks were cut) with geotextile fabric and protect with aggregate to a depth of 4 inches.
- Fords are prohibited when the stream banks are 4 feet or more in height above the invert of the stream and a bridge or culvert crossing can easily be constructed.
- The approach roads at the cut banks are no steeper than 5:1.
- Install shallow swales to convey overland flow away from the temporary access ford approaches. Swales return to overland flow at the downstream end of the approach or otherwise discharge to the stream in a non-erosive way using outlet protection or level spreaders as necessary.

### **8.3.5 Construction Specifications**

Use the following sequencing for implementation of the temporary access ford:

1. Implement all erosion and sediment control devices, including dewatering basins.
2. Place one layer of geotextile fabric on the streambed, streambanks, and road approaches prior to placing the bedding material on the stream channel or approaches. Extend the geotextile fabric a minimum of 6 inches and a maximum of 1 foot beyond bedding material.
3. The bedding material is coarse aggregate or gabion mattresses filled with coarse aggregate.

4. Construct all fords to minimize the blockage of stream flow and to allow free flow over the ford. The placing of any material in the stream bed will cause some upstream ponding. The depth of this ponding will be equivalent to the depth of the material placed within the stream and therefore keep to a minimum height. However, in no case will the bedding material be placed deeper than 12 inches or half the height of the existing banks, whichever is smaller.
5. The contractor ensures that a continuous perimeter control barrier is in place to minimize the amount of pollutants entering the flow. Install a diversion pipe or other measure and use sandbag/stone diversions to divert stream flow.
6. Divert the stream using an approved temporary stream diversion, dewater the construction area, and stabilize any disturbed banks during ford installation.
7. Install the floodplain swales during ford construction along with any energy dissipation measures at their downstream terminus.
8. Stabilize all areas disturbed during ford installation in accordance with the standards and specifications in this manual.
9. Once the crossing is completed, remove the diversion from upstream to downstream. Sediment control devices, including perimeter erosion controls, are to remain in place until all disturbed areas are stabilized in accordance with an approved sediment and erosion control plan and the inspection authority approves their removal.

#### **8.3.6 Maintenance**

During construction, inspect in-stream diversion daily during the work week for leakage and repair as necessary. Ensure that a continuous perimeter control barrier is in place to minimize the amount of pollutants entering the flow. Inspect area upstream and downstream for bed or stream bank scour. Repair and stabilize as necessary. If erosion is excessive, then remove the ford.

To remove the temporary access ford,

1. Inspect the site to determine the practice is no longer needed.
2. Remove sediment buildup (if applicable).
3. Divert the stream using an approved temporary stream diversion method, dewater the construction area, and remove the practice (including floodplain swales and temporary energy dissipation measures). Stabilize all areas disturbed during ford installation prior to removal of the stream diversion.
4. Upon stabilization, the stream diversion can be removed and stabilized per standards and specification in this manual.
5. Revegetate area disturbed by practice removal (if applicable).

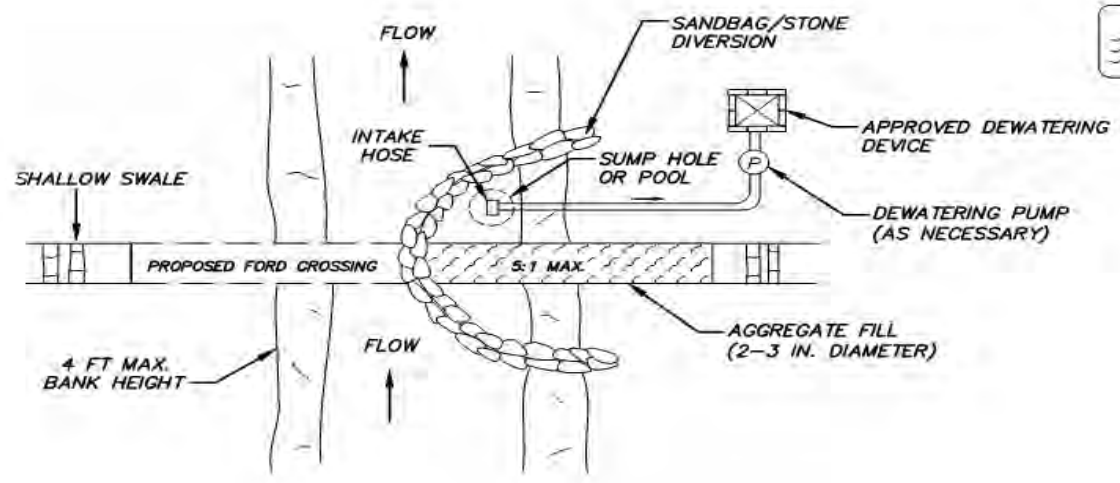

STANDARD SYMBOL  
 T.A.C.

**PLAN VIEW**

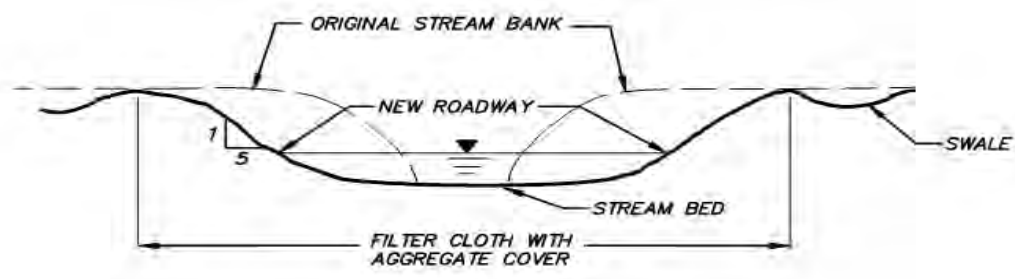

**SECTION VIEW**

DATE	APPR	
REVISD		
ISSUED:		
		REFERENCE

**TEMPORARY  
ACCESS FORD**

\*\*\* DISTRICT OF COLUMBIA  
 DEPARTMENT OF ENERGY &  
 ENVIRONMENT

DWG. NO 803.1

SOURCE: 2011 MARYLAND STANDARDS AND SPECIFICATIONS

**Detail 54 – 803.1 Temporary Access Ford**

## **8.4 Temporary Access Culvert**

### **8.4.1 Definition**

A temporary structure consisting of a section(s) of circular pipe, pipe arches, or oval pipes of reinforced concrete, corrugated metal, or structural plate for conveying flowing water through a crossing.

### **8.4.2 Purpose**

To convey flowing water through a stream crossing.

### **8.4.3 Conditions Where Practice Applies**

Temporary access culvert is appropriate if a short-term method for construction vehicles to cross a stream is needed. This temporary stream crossing method is normally preferred over a ford type of crossing, since disturbance to the stream is only during construction and removal of the culvert.

Limitations include the following:

- Culverts may not be appropriate for large streams or during high flow conditions. Consider alternative crossing methods such as a temporary bridge.
- Culvert crossings may cause damage to the channel cross section; therefore, limit their use for any one project. Strategic placement of crossings can reduce the number of crossings needed during construction.
- Do not install culvert crossings on streams that are significantly vertically degraded or incised. The degree of vertical degradation, also referred to as floodplain disconnection, can be directly measured using fluvial geomorphological parameters such as bank height ratio (BHR) or entrenchment ratio (ER); however, this should only be conducted by a qualified professional. In most cases, use the culvert sizing design criteria to determine whether the cross-sectional area of the proposed pipe(s) is sufficient to install a culvert crossing.

### **8.4.4 Design Criteria**

The following design criteria apply:

- Culverts must have a minimum capacity sufficient to convey the 1-year flow for projects with duration of 2 weeks or less. For projects of longer duration, culverts must have a capacity sufficient to convey the 2-year flow without overtopping.
- All culverts must be strong enough to support their cross sectional area under maximum expected loads.
- The size of the culvert pipe must be the largest pipe diameter that will fit into the existing channel without major excavation of the stream channel or without major approach fills. If a channel width exceeds 3 feet, additional pipes may be used until the cross sectional area of

the pipes is greater than 60% of the cross sectional area of the existing channel. The minimum size culvert that may be used is a 12-inch diameter pipe. In all cases, the pipe(s) must be large enough to convey design stream flows.

- Consider multiple culverts or elliptical culverts to achieve flow capacity while providing minimum cover requirements.
- The culvert slope should match the streambed slope while not exceeding 3%.
- Ensure that design flow velocity at the outlet of the crossing structure is non-erosive for the receiving stream channel and install outlet protection, Section 5.1 Rock Outlet Protection, as necessary.
- Geomembrane must consist of polyethylene or other material, which is impermeable and resistant to puncture and tearing.
- If in-channel disturbance is necessary for culvert installation, employ a temporary stream channel diversion per an approved standards and specifications in this manual.

#### **8.4.5 Construction Specifications**

Use the following sequence for implementing the temporary access culvert:

1. Keep clearing and excavation of the stream banks, bed, and approach sections to a minimum.
2. Extend the culvert(s) a minimum of 1 foot beyond the upstream and downstream toe to the aggregate placed around the culvert. The culvert should not exceed 40 feet in length.
3. Place geotextile fabric on the streambed and stream banks prior to placement of the pipe culvert(s) and aggregate. The geotextile fabric should cover the streambed and extend a minimum 6 inches and a maximum 1 foot beyond the end of the culvert and bedding material. Geotextile fabric reduces settlement and improves crossing stability.
4. Install the invert elevation of the culvert on the natural streambed grade to minimize interference with fish migration (free passage of fish).
5. Backfill the culvert with Class I riprap and 6 inches depth of #57 washed stone to act as the road crossing. Backfill should meet minimum cover requirements for the culvert and should at a minimum be approximately 1 foot higher than the grade at either approach to prevent erosion from surface runoff.
6. Cover the culvert(s) with a minimum of 1 foot of aggregate. Minimum coverage should be in conformance with manufacturer's specifications. If multiple culverts are used, separate them by at least 12 inches of compacted aggregate fill.

#### **8.4.6 Maintenance**

During construction, periodically inspect to ensure that the culverts, streambed, and streambanks are not damaged, and that sediment is not entering the stream or blocking fish passage or migration. Periodically inspect the diversion pipe outlet for excessive scour of the streambed and repair or add outlet protection as necessary. Perform maintenance as needed to ensure that the structure complies with the standards and specifications. This includes removal and disposal of any trapped sediment or debris. Dispose sediment outside of the floodplain and stabilize. After

runoff-producing rains, inspect stream crossing to check for blockages, erosion of abutments, channel scour, riprap displacement or piping.

To remove the temporary access culvert:

1. Inspect the site to determine the practice is no longer needed.
2. When the crossing has served its purpose, remove all structures, including culverts, bedding and geotextile fabric materials, within 14 calendar days. In all cases, remove the culvert materials within one year of installation. Remove sediment buildup (if applicable).
3. Restore the stream channel to its original cross-section, and smooth and appropriately stabilize all disturbed areas.
4. Revegetate area disturbed by practice removal (if applicable).



STANDARD SYMBOL  
TAC

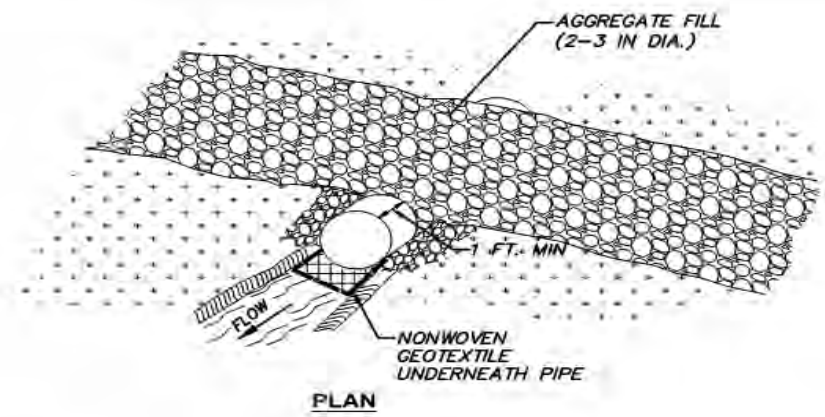

NOTE: FOR INSTALLATION PROCEDURES (SEE DETAIL 818.1 & 818.2)

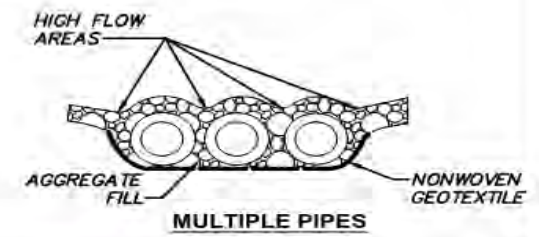
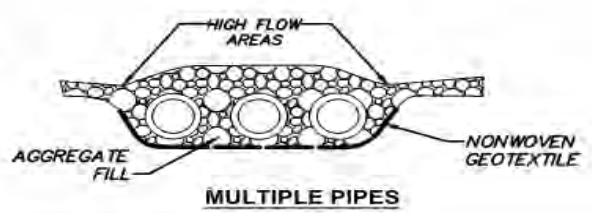
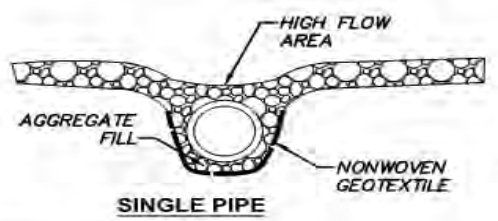
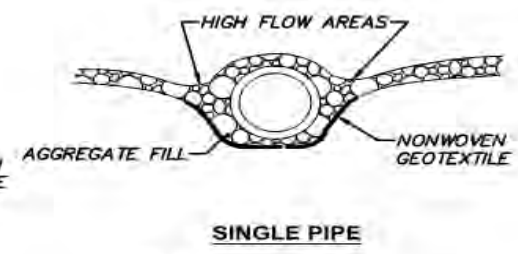
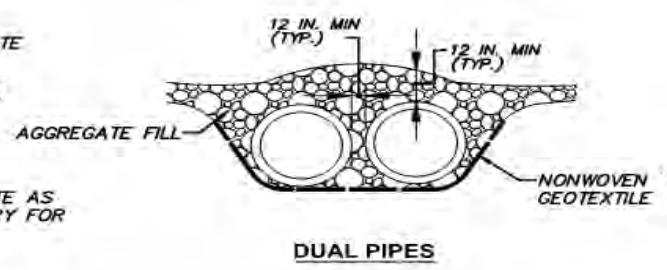
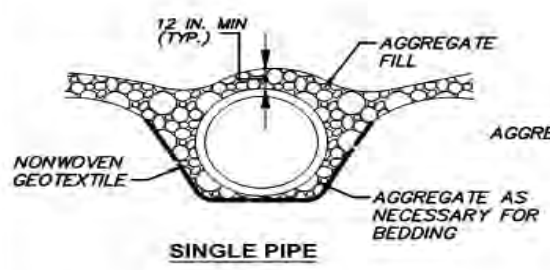

DATE	APPR	
REVISED		
ISSUED:		
	REFERENCE	

**TEMPORARY ACCESS CULVERT**

\*\*\* DISTRICT OF COLUMBIA DEPARTMENT OF ENERGY & ENVIRONMENT

DWG. NO 804.1

SOURCE: 2011 MARYLAND STANDARDS & SPECIFICATIONS

Detail 55 – 804.1 Temporary Access Culvert

## **8.5 Temporary Access Bridge**

### **8.5.1 Definition**

Temporary bridge made of wood, metal, or other materials designed to limit the amount of disturbance to the stream banks and bed.

### **8.5.2 Purpose**

Temporary access bridge poses the least chance for interference with fish migration when compared to the other temporary access stream crossings.

### **8.5.3 Conditions Where Practice Applies**

This is the preferred method for temporary access stream crossings. Normally, bridge construction causes the least disturbance to the streambed and banks when compared to the other access stream crossings. Disturbance to the stream banks are kept to a minimum.

Construction, use, or removal of a temporary access bridge will not normally have any time of year restrictions since construction, use, or removal should not affect the stream or its banks, unless the bridge is built with a pier(s) in the water. Large channels can limit the use of temporary access bridges.

### **8.5.4 Design Criteria**

The following design criteria apply:

- Stringers should either be logs, sawn timber, prestressed concrete beams, metal beams, or other approved materials.
- Deck materials should be of sufficient strength to support the anticipated load.
- If in-channel disturbance is necessary for bridge installation, employ a temporary stream channel diversion per approved standards and specifications in this manual.

### **8.5.5 Construction Specifications**

Use the following sequencing for implementation of the temporary access bridge:

1. Construct the temporary bridge structure at or above the bank elevation to prevent the entrapment of floating materials and debris.
2. Place abutments parallel to, and on, stable banks.
3. Construct bridges to span the entire channel. If the channel width exceeds 8 feet, (as measured from top-of-bank to top-of-bank), then a footing, pier, or bridge support may be constructed within the stream. One additional footing, pier, or bridge support will be permitted for each additional 8-foot width of the channel. However, no footing, pier, or bridge support will be permitted within the channel for streams less than 8 feet wide.

4. Decking materials must be of sufficient strength to support the anticipated load. Place all decking members perpendicular to the stringers, butted tightly, and fastened securely to the stringers. Decking materials must be butted tightly to prevent any soil material tracked onto the bridge from falling into the stream below.
5. Securely fasten run planking (optional) to the length of the span. Provide one run plank for each track of the equipment wheels. Although run planks are optional, they may be necessary to properly distribute loads.
6. Install curbs or fenders (optional) along the outer sides of the deck. Curbs or fenders provide additional safety.
7. Securely anchor bridges at only one end using steel cable or chain. Anchoring at only one end will prevent channel obstruction if floodwaters float the bridge. Acceptable anchors are large trees, large boulders, or driven steel anchors. Anchoring must prevent the bridge from floating downstream and possibly causing an obstruction to the flow.
8. Stabilize all areas disturbed during the bridge installation in accordance with the standards and specifications in this manual.
9. All temporary access bridges installed on public right-of-way must be approved by DDOT.

#### **8.5.6 Maintenance**

During construction, inspect to ensure that the bridge, streambed, and stream banks are maintained and not damaged. Perform maintenance as needed to ensure that the structure complies with the standards and specifications. This includes removal and disposal of any trapped sediment or debris. Dispose sediment outside of the flood plain and stabilize.

To remove the temporary access bridge:

1. Inspect site to determine practice is no longer needed.
2. Remove all structures including abutments and other bridging materials within 14 days.
3. Inspect work area to ensure channel bank stabilization measures have been installed including seed and mulch or seed and matting as specified on the plans.
4. Stabilize and revegetate area disturbed by bridge removal.

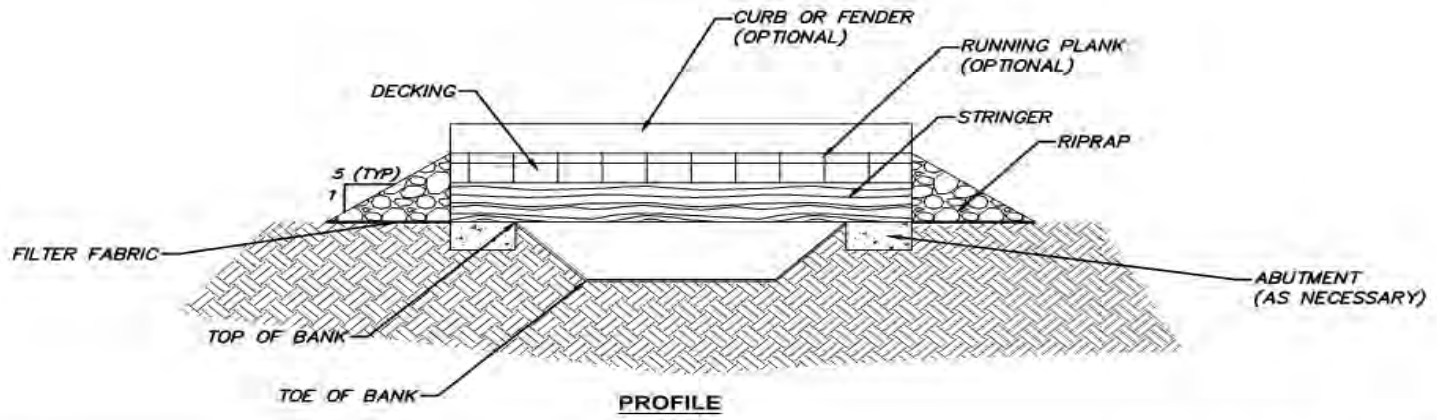
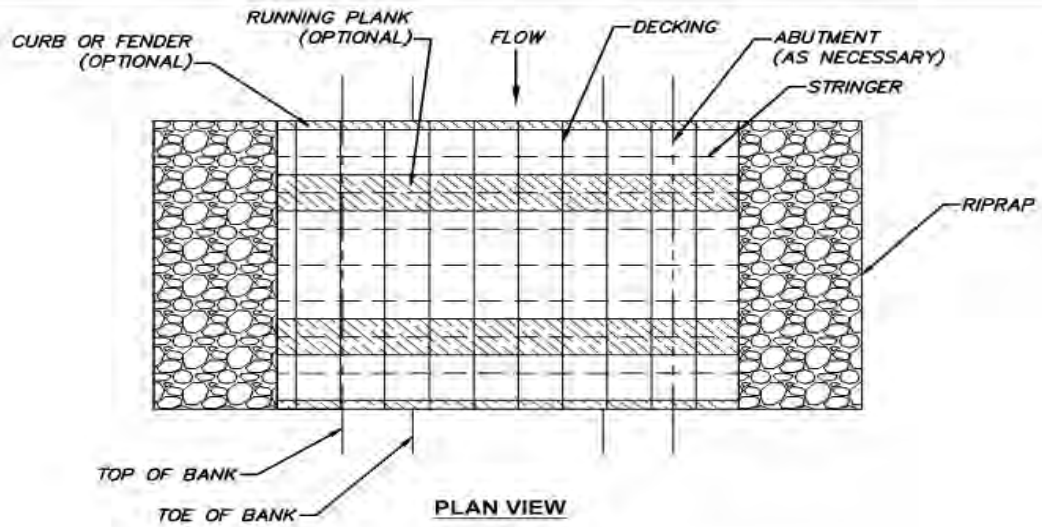
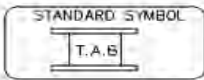

DATE	APPR	
REVISED		
ISSUED:		
	REFERENCE	

**TEMPORARY ACCESS BRIDGE**

★ ★ ★ DISTRICT OF COLUMBIA  
 DEPARTMENT OF ENERGY &  
 ENVIRONMENT

DWG. NO 805.1

SOURCE: ECOSYSTEM SERVICES, BAKER, CITY OF CHARLOTTE

Detail 56 – 805.1 Temporary Access Bridge

## **8.6 Access Roads**

### **8.6.1 Definition**

Access roads are temporary roads that are designed and built to access the stream project.

### **8.6.2 Purpose**

To transport materials and equipment to the site.

### **8.6.3 Conditions Where Practice Applies**

Temporary access roads are appropriate where a stream project cannot be constructed solely with hand labor and will require heavy equipment. Carefully mark access through a riparian area to minimize impacts and to aid in the subsequent restoration efforts. Different types of equipment can handle different road conditions.

### **8.6.4 Design Criteria**

The following design criteria apply:

- Consult a certified arborist if construction traffic will occur above tree roots.
- Surface treatment can consist of geotextile material overlain with 6 inches of gravel, 6 inches of mulch, 6 inches of mulch overlain with timber mats or approved alternative, or a combination of these techniques. Generally, these techniques are ordered in applicability from less sensitive to more sensitive ground conditions.
- The need for equipment to maintain traction will drive important design decisions if ground conditions at the site are slippery, steep, or soft.

The following are general guidelines:

- In the stream buffer, a minimum of 6 inches of mulch can be placed as an access road. Access can also be achieved using a minimum of 6 inches of mulch with temporary mats (e.g., timber mats).
- Outside of the stream buffer, access roads can be constructed by placing road gravel on geotextile materials laid directly on the ground surface. Some of the plastic products on the market (PVC, PVE, etc.) can be used to reinforce low-load-bearing soils. This approach is appropriate when access roads will be used frequently for hauling materials or equipment or for refueling operations.
- Use existing access points when available and construct new access points in a manner that minimizes riparian impacts. When habitat impacts from construction activity exist, mitigation may be required to compensate for lost functions.

### **8.6.5 Construction Specifications**

1. Access routes are verified by the engineer at the pre-construction meeting. Revisions to the alignment that minimize tree disturbance are encouraged and require review and approval by design engineer.
2. Contractor must maintain mulch mat throughout construction period.
3. The haul road is designed to prevent compaction of existing soils using low ground pressure equipment which exerts no more than 8 psi. If the contractor intends to use any equipment with higher loads additional protection measures must be provided such as hardwood mats (see Detail 806.1).

### **8.6.6 Maintenance**

Ensure that signage remains in place to identify the access areas. Access roads may require periodic cleaning or additional material placement. Inspect timber mats for damage and replaced as necessary.

To remove the access road:

1. Inspect site to determine practice is no longer needed.
2. Remove surface treatment. Mulch may be left in riparian areas per approved plans. Mulch may not be left in the floodplain.
3. Roughen ground surface and apply final stabilization practice as specified.
4. Re-vegetate area disturbed by practice removal (if applicable).



STANDARD SYMBOL  
A.R.

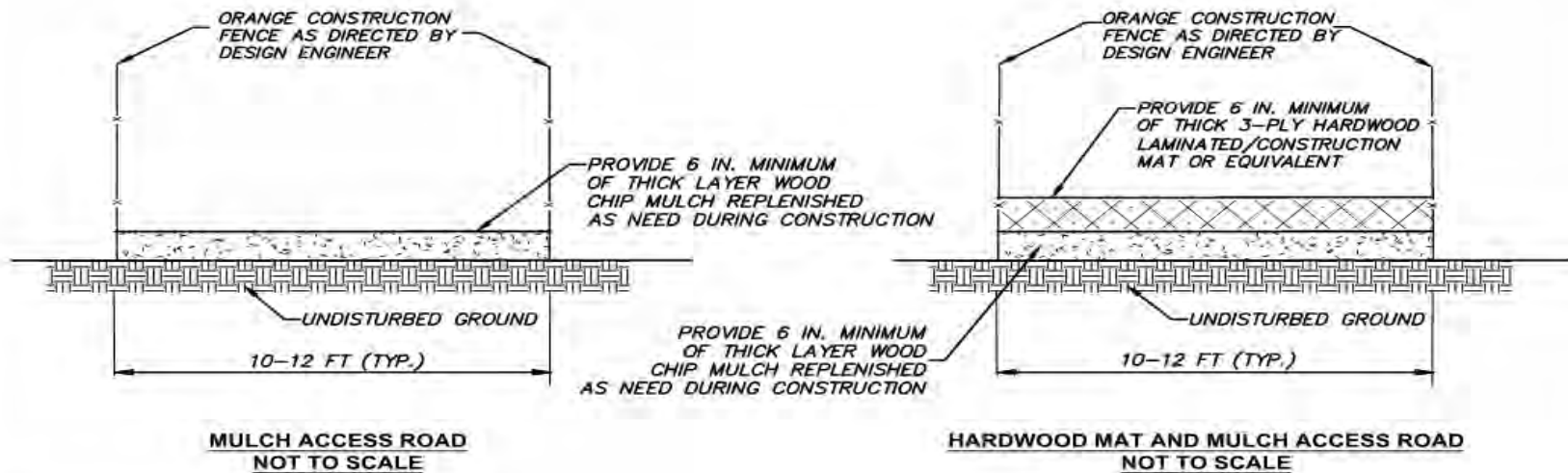

**CONSTRUCTION SPECIFICATIONS**

1. ACCESS ROUTES TO BE VERIFIED BY ENGINEER AT PRE-CONSTRUCTION MEETING. REVISIONS TO THE ALIGNMENT THAT MINIMIZE TREE DISTURBANCE ARE ENCOURAGED AND REQUIRE REVIEW AND APPROVAL BY DESIGN ENGINEER.
2. CONTRACTOR SHALL MAINTAIN MULCH MAT THROUGHOUT CONSTRUCTION PERIOD.
3. THE HAUL ROAD IS DESIGNED TO PREVENT COMPACTION OF EXISTING SOILS USING LOW GROUND PRESSURE EQUIPMENT WHICH EXERTS NO MORE THAN 8 PSI. IF THE CONTRACTOR INTENDS TO USE ANY EQUIPMENT WITH HIGHER LOADS ADDITIONAL PROTECTION MEASURES MUST BE PROVIDED SUCH AS HARDWOOD MATS. (SEE DETAILS ABOVE).

DATE	APPR	
REVISED		
ISSUED:		
	REFERENCE	

**ACCESS ROADS**

\*\*\* DISTRICT OF COLUMBIA  
DEPARTMENT OF ENERGY &  
ENVIRONMENT

DWG. NO 806.1

SOURCE: ECOSYSTEM SERVICES, BAKER, CITY OF CHARLOTTE

## **8.7 Temporary Stockpile and Disposal Areas**

### **8.7.1 Definition**

Temporary storage of construction or waste materials.

### **8.7.2 Purpose**

Any significant movement of materials on-site, off-site or within the site will require a stockpile area for temporary storage of construction or waste materials. Proper management of excess materials reduces or eliminates wind and water erosion.

### **8.7.3 Conditions Where Practice Applies**

Use of a temporary stockpile and disposal areas is appropriate for all projects requiring significant movement of materials on-site or off-site. Improper stockpile management can result in additional disturbance and damage to site.

### **8.7.4 Design Criteria**

The following design criteria apply:

- Locate all stockpiles within construction limits.
- Locate stockpiles away from drainage courses and storm drain inlets.
- Locate stockpiles away from sensitive areas including steep slopes.

### **8.7.5 Construction Specifications**

The following are general guidelines:

1. Careful consideration of stockpile size and location will facilitate construction, reduce cost and limit damage to sensitive areas. The location of stockpiles can significantly increase or decrease cost relative to cycle time for construction operations.
2. Cover soil stockpiles and contain them within temporary perimeter sediment barriers, such as berms, dikes, silt fences, or sandbag barriers.
3. Stockpiles that remain more than 7 days must be temporarily seeded and mulched to stabilize soil and deter runoff.

### **8.7.6 Maintenance**

During construction, periodically maintain perimeter controls and covers to ensure proper functioning. Inspect stockpile and disposal areas after a rain event for scour or evidence that perimeter controls are being bypassed.



To remove the temporary stockpile area:

1. Inspect site to determine practice is no longer needed.
2. Remove perimeter controls and diversions.
3. Remove material to designated area or approved and permitted disposal site.
4. Re-vegetate area disturbed by practice removal.

## **8.8 Pump-Around Practice**

### **8.8.1 Definition**

Temporary dewatering practice for pumping flow around segments of in-channel stream construction.

### **8.8.2 Purpose**

To divert base flow around sections or reaches of the stream using a temporary pump-around system in combination with additional support measures, such as in-stream diversions. The intercepted water from the work area is discharged to an acceptable dewatering practice.

### **8.8.3 Conditions Where Practice Applies**

Pump-around is appropriate if construction activities require that a segment of the stream be temporarily dewatered and maintained in a dry condition and the pump size can accommodate the stream base-flow rate. It is used in ditches, streams, channels, swales, and excavations.

Consider the following limitations before choosing pump-around:

- Determine the amount of flow capable of being diverted by the capacity of the pump and the site configuration. Pump-around may not be appropriate for larger streams with high base flows.
- Costs are proportional to diversion requirements.
- Pumps can break down and cause delays.
- Determine the length of stream to be dewatered by the amount of work that can be completed in one workday. Continuous pumping adds increased costs and risks of failure.

### **8.8.4 Design Criteria**

The following design criteria apply:

- Size the pump using manufacturer's pump curve and site specific calculations of total dynamic head.
- Pump capacity should always be greater than that required to pump the desired base flow.
- Height of in-stream diversions must be the normal base-flow/design depth plus a minimum 1 foot of freeboard for sandbag/stone diversions that will be installed and removed in the same workday.
- Height of sandbag/stone diversions for a continuous pump-around must be a minimum height of 2 feet.
- In very small channels where the depth of the channel does not exceed 2 feet, the in-sandbag/stone diversions must extend to the channel top of bank.

- Pumping equipment can be electric, diesel or gasoline venturi, vacuum, or centrifugal primed pump or equivalent and have appropriately sized intake and discharge pipe/hose with positive restrained joints. Include the necessary pipe connectors and properly store the fuel.
- Dewater using the Section 8.19 Dewatering Basin specification or Section 7.4 Pumped Water Filter Bag specification and manufacturer's specifications.
- Follow the specifications in Section 5.1 Rock Outlet Protection or Section 5.2 Plunge Pool/Stilling Basin for non-erosive velocity discharge dissipation.
- Size riprap or sandbags to resist the 1-year flow if the duration of the project is less than 2 weeks. Otherwise, design to resist the 2-year flow.
- Riprap must be washed and have a minimum diameter of 6 inches.
- The in-stream diversion must be either riprap and stone of mixed sizes to minimize void space or sandbags. Sandbags may be filled on site or prefilled and made of burlap or polypropylene materials that are resistant to ultraviolet radiation, tearing, and puncture and must be woven tightly enough to prevent leakage of the fill material (i.e., sand, fine gravel, etc.).
- Impermeable geomembrane must consist of polyethylene or other material that is impervious and resistant to puncture and tearing.
- Adhere to the design criteria for Section 8.13 Sandbag/Stone Channel Diversion for in-stream diversions.

### **8.8.5 Construction Specifications**

Use the following specifications for implementation of the pump-around practice:

1. Do not construct the pump-around until all sediment and erosion control measures have been installed, necessary easements and permits acquired, and proper regulatory notifications made.
2. The contractor should only begin work in an area which can be completed by the end of the day including grading adjacent to the channel.
3. Situate sandbag dikes or other approved diversion at the upstream and downstream ends of the work area as shown on the plans, and pump around clean stream flow upstream of the work area. Discharge the pump onto a stable velocity dissipator made of riprap per the plans and details.
4. Install the impermeable geomembrane by placing the bottom course of sandbags or riprap on top of at least 1 foot of the geomembrane. Extend the geomembrane along the upstream face of the diversion and cover the downstream portion with at least an 18-inch overlap.
5. Where possible, utilize existing pools within the stream in place of an excavated sump-hole.
6. Pump sediment-laden water from the work area to a sediment filtering device such as a dewatering basin, filter bag, or other approved practice. Locate the device such that the water drains back into the channel below the downstream diversion.

7. Work should proceed from upstream to downstream unless otherwise specified and approved by the engineer.
8. After a work area is completed and stabilized, remove the upstream diversion. Do not remove the downstream diversion until all sediment-laden water from the removal of the upstream diversion has been filtered through the sediment filter device.
9. Upon removal of the downstream diversion, install an upstream and downstream diversion in a new work area as described previously and repeat the pump around operation (see Detail 808.1).
10. At the end of each work day, stabilize the work area and remove the pump around operation (including diversions) from the channel.
11. Note that a pump-around must be installed on any tributary or storm drain outfall that contributes base flow to the work area. This is accomplished by locating a sandbag diversion at the downstream end of the tributary or storm drain outfall and pumping the stream flow around the work area. Discharge this water onto the same velocity dissipator used for the main stem pump around.

#### **8.8.6 Maintenance**

During construction, inspect in-stream diversion for leakage and repair as necessary. Inspect pump-around practice to ensure flow is adequately diverted through the pump. Inspect for leakage and repair as necessary. Inspect dewatering device and ensure discharge is not sediment laden. Inspect discharge point for erosion. Repair as necessary.

To remove the pump-around practice:

1. Inspect the site to determine the practice is no longer needed.
2. Inspect the work area to ensure channel bank stabilization measures have been installed, including seed and mulch or seed and matting, as specified on the plans.
3. Remove the upstream diversion.
4. Repair the sump-hole (if applicable).
5. Remove sediment buildup in the work area (if applicable).
6. Remove the downstream diversion.
7. Restore the stream channel to its original or design cross-section and revegetate area disturbed by practice removal as per the planting plan.



## **8.9 Culvert Pipe with Access Road**

### **8.9.1 Definition**

Temporary diversion practice used to create construction access for in-channel construction while providing construction vehicles a means to cross a stream.

### **8.9.2 Purpose**

To divert base flow around sections or reaches of in-channel stream construction using a diversion pipe and flow diversions in combination with a temporary stream crossing for construction vehicles. The intercepted water from the work area is discharged to an acceptable dewatering practice.

### **8.9.3 Conditions Where Practice Applies**

A culvert pipe with access road can be used effectively for installation of utility lines at stream crossings, stream bank grading, and in-stream construction that will require heavy equipment traffic across the channel.

Limitations include the following:

- Diversions that have an insufficient flow capacity can fail and severely erode the disturbed channel section under construction. Therefore, in-channel construction activities should occur only during periods of low rainfall.
- In-channel construction that requires bed modifications are not recommended due to interference with diversion pipe.

### **8.9.4 Design Criteria**

The following design criteria apply:

- Design according to Section 8.2 Temporary Access Stream Crossings.
- Height of in-stream diversions must be the normal base flow/design depth plus a minimum 1 foot of freeboard for sandbag/stone diversions that will be installed and removed in the same workday.
- Height of sandbag/stone diversions for a continuous pump-around must be a minimum height of 2 feet.
- In very small channels where the depth of the channel does not exceed 2 feet, the in-sandbag/stone diversions must extend to the channel top of bank.
- Pumping equipment can be electric, diesel or gasoline venturi, vacuum, or centrifugal primed pump or equivalent and have appropriately sized intake and discharge pipe/hose with positive restrained joints. Include the necessary pipe connectors and properly store the fuel.
- Dewater using the Section 8.19 Dewatering Basin specification or Section 7.4 Pumped Water Filter Bag specification and manufacturer's specifications.

- Follow the specifications in Section 5.1 Rock Outlet Protection or Section 5.2 Plunge Pool/Stilling Basin for non-erosive velocity discharge dissipation.
- Size riprap or sandbags to resist the 1-year flow if the duration of the project is less than 2 weeks. Otherwise, design to resist the 2-year flow.
- Riprap must be washed and have a minimum diameter of 6 inches.
- The in-stream diversion must be either riprap and stone of mixed sizes to minimize void space or sandbags. Sandbags may be filled on site or prefilled and made of burlap or polypropylene materials that are resistant to ultraviolet radiation, tearing, and puncture, and must be woven tightly enough to prevent leakage of the fill material (i.e., sand, fine gravel, etc.).
- Impermeable geomembrane must be polyethylene or other material that is impervious and resistant to puncture and tearing.
- Adhere to the design criteria for Section 8.13 Sandbag/Stone Channel Diversion for in-stream diversions.

### **8.9.5 Construction Specifications**

Construct a culvert pipe with a temporary access road as follows:

1. Install the upstream sandbag/stone diversion or other approved diversion in conjunction with the diversion pipe.
2. Install the impermeable geomembrane by placing the bottom course of sandbags or riprap on top of at least 1 foot of the geomembrane. Extend the geomembrane along the upstream face of the diversion and cover the downstream portion with at least an 18-inch overlap.
3. Construct temporary access stream crossings in accordance with the specifications in Section 8.2 Temporary Access Stream Crossings.
4. Pump all sediment-laden flow from the construction site to an approved dewatering device per Section 8.19 Dewatering Basins or Section 7.4 Pumped Water Filter Bags and manufacturer's specifications prior to reentering the stream.
5. Protect the pump discharge line from construction traffic. A recommended approach is to dig an open trench across the access road, place the pump discharge line within the trench, and cover the trench with a wooden track mat.
6. Provide velocity dissipation measures at the diversion culvert's outlet to prevent stream bed scour. If riprap is utilized, size according to Section 5.1 Rock Outlet Protection.

### **8.9.6 Maintenance**

Adhere to the Section 8.4 Temporary Access Culvert maintenance specifications in addition to the following items:

During construction, inspect in-stream diversion for leakage and repair as necessary. Inspect pump-around practice to ensure flow is adequately diverted through the pump. Inspect for leakage and repair as necessary. Inspect dewatering basin and ensure discharge is not sediment

laden. Inspect discharge point for erosion. Repair as necessary. Periodically check the outlet of the culvert to ensure flow is not sediment laden.

To remove the culvert pipe with access road:

1. Inspect the site to determine practice is no longer needed.
2. Inspect to ensure channel bank stabilization measures have been installed, including seed and mulch or seed and matting, as specified on the plans.
3. Remove the flow diversion.
4. Remove sediment buildup (if applicable).
5. Remove the culvert crossing.
6. Restore the stream channel to its original cross-section, and smooth and appropriately stabilize all disturbed areas.
7. Revegetate the area disturbed by practice removal (if applicable).



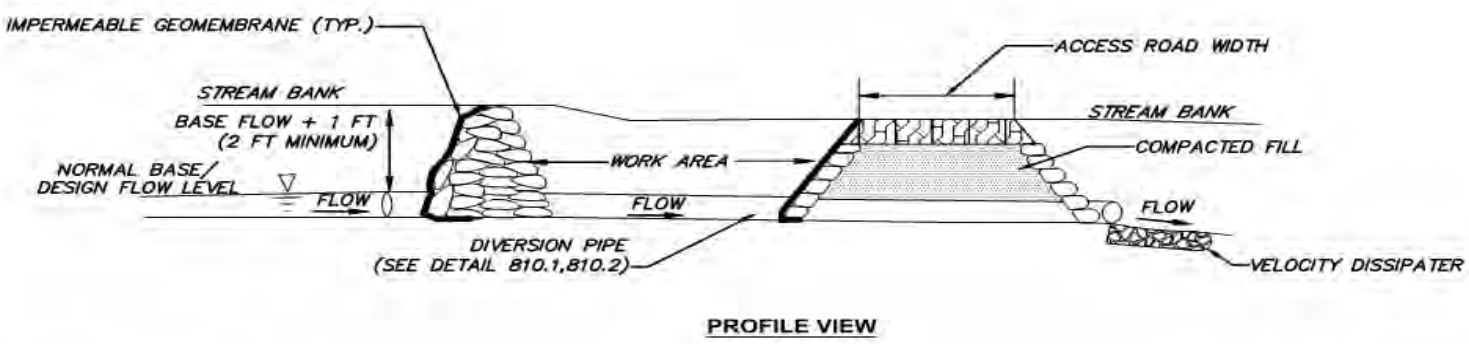
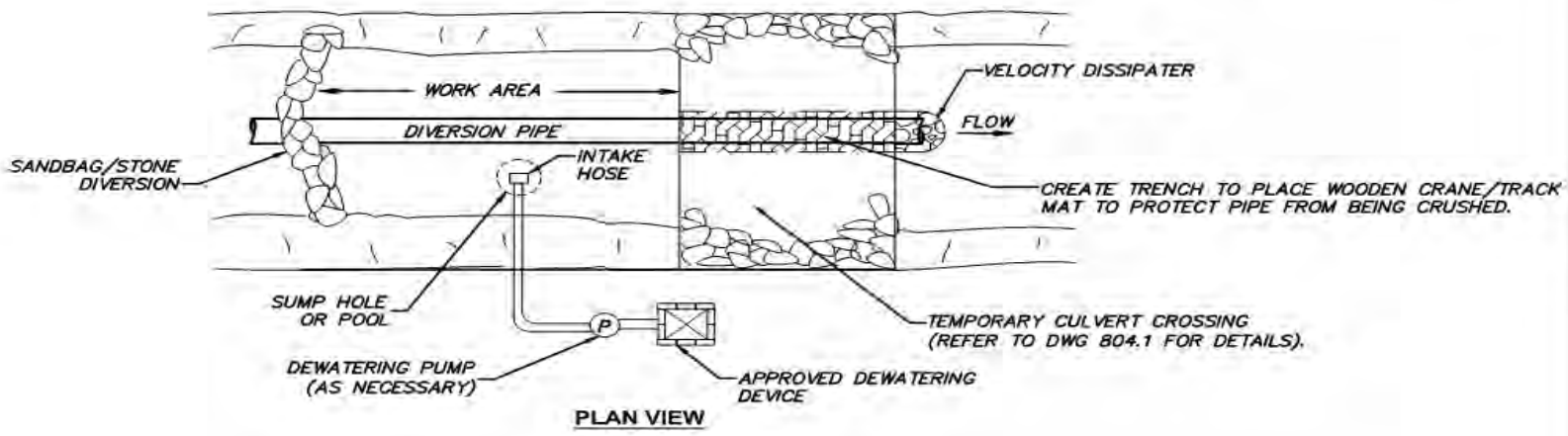
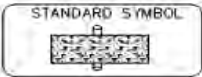

DATE	APPR	
REVISED		
ISSUED:		
	REFERENCE	

**CULVERT PIPE  
WITH ACCESS  
ROAD**

 DISTRICT OF COLUMBIA  
 DEPARTMENT OF ENERGY &  
 ENVIRONMENT

DWG. NO 809.1

SOURCE: 2011 MARYLAND STANDARDS & SPECIFICATIONS

Detail 59 – 809.1 Culvert Pipe with Access Road

## **8.10 Diversion Pipe**

### **8.10.1 Definition**

Temporary dewatering practice that diverts water flow into a pipe for a segment of the stream to allow for in-channel construction.

### **8.10.2 Purpose**

To divert flow around sections or reaches of the stream using a temporary pipe in combination with additional support measures, such as sandbag or stone diversions when construction activities need to occur in the stream channel. The intercepted water from the work area is discharged to an acceptable dewatering practice.

### **8.10.3 Conditions Where Practice Applies**

A diversion pipe is appropriate if construction activities require that a reach of the stream be dewatered and maintained in a dry condition, restoration practices that span the entire width of the stream are installed, the flow required to be diverted can be accomplished without pumping, and there is a positive slope to allow flow through the pipes.

Consider the following limitations before using a diversion pipe:

- Due to stability issues, equipment cannot be driven over pipes. If there is a possibility of the pipes being driven over by construction equipment, use Section 8.2 Temporary Access Stream Crossings.
- Diversion pipes are difficult to use for grade control structures, which span the entire channel.
- After installation, apparatus is difficult to adjust or move without completely removing.
- Diversion pipes with an insufficient flow capacity can cause the channel diversion to fail, thereby resulting in severe erosion of the disturbed channel section under construction. Therefore, conduct in-channel construction activities only during periods of low flow.

### **8.10.4 Design Criteria**

The following design criteria apply:

- Use high density polyethylene pipe (HDPE) pipe or equivalent of appropriate thickness and diameter to accomplish diversion of stream flow. Extend the pipe a minimum of 1 foot beyond the upstream and downstream toes of the diversions.
- Pipe must have a minimum capacity sufficient to convey the 1-year flow for projects with duration of 2 weeks or less. For projects of longer duration, culverts must have a capacity sufficient to convey the 2-year flow without overtopping.

- The height of in-stream diversions must be the normal base flow/design depth plus a minimum 1 foot of freeboard for sandbag/stone diversions that will be installed and removed in the same workday.
- The height of sandbag/stone diversions for a continuous pump-around must be a minimum of 2 feet.
- In very small channels where the depth of the channel does not exceed 2 feet, the in-stream sandbag/stone diversions must extend to the channel top of bank.
- Pumping equipment can be electric, diesel or gasoline venturi, vacuum, or centrifugal primed pump or equivalent and have appropriately sized intake and discharge pipe/hose with positive restrained joints. Include the necessary pipe connectors and properly store the fuel.
- Dewater using the Section 8.19 Dewatering Basin specification or Section 7.4 Pumped Water Filter Bag specification and manufacturer's specifications.
- Follow the specifications in Section 5.1 Rock Outlet Protection or Section 5.2 Plunge Pool/Stilling Basin for non-erosive velocity discharge dissipation.
- Size riprap or sandbags to resist the 1-year flow if the duration of the project is less than 2 weeks. Otherwise, design them to resist the 2-year flow.
- Riprap must be washed and have a minimum diameter of 6 inches.
- The in-stream diversion must be either riprap and stone of mixed sizes to minimize void space or sandbags. Sandbags may be filled on site or prefilled and made of burlap or polypropylene materials that are resistant to ultraviolet radiation, tearing, and puncture, and must be woven tightly enough to prevent leakage of the fill material (i.e., sand, fine gravel, etc.).
- Impermeable geomembrane must consist of polyethylene or other material that is impervious and resistant to puncture and tearing.
- Adhere to the design criteria for Section 8.13 Sandbag/Stone Channel Diversion for in-stream diversions.

### **8.10.5 Construction Specifications**

Use the following sequencing to implement a diversion pipe:

1. Implement all erosion and sediment control devices, including mandatory dewatering basins, prior to installing the diversion pipe. Install during low flow conditions.
2. Install an appropriately sized diversion pipe per the plans.
3. Situate sandbag/stone diversions or other approved diversions at the upstream and downstream ends of the work area as shown on the plans, and divert stream flow around the work area.
4. Install the impermeable geomembrane by placing the bottom course of sandbags or riprap on top of at least 1 foot of the geomembrane. Extend the geomembrane along the upstream face of the diversion and cover the downstream portion with at least an 18-inch overlap.

5. Deposit and stabilize all excavated material in an approved area outside the 100-year floodplain, unless otherwise authorized.
6. Provide velocity dissipation measures at the diversion culvert's outlet to prevent stream bed scour. If riprap is utilized, size it according to Section 5.1 Rock Outlet Protection.
7. Pump sediment-laden water from the construction area to an approved dewatering device.

#### **8.10.6 Maintenance**

During construction, periodically inspect diversion pipe during the work week. Ensure flow is adequately diverted. Inspect for leakage and repair as necessary. Periodically check the outlet of the culvert to ensure flow is not sediment laden. Inspect the discharge point for erosion. Repair as necessary. Inspect the in-stream diversion for leakage and repair as necessary. Inspect the pump-around practice to ensure flow is adequately diverted through the pump. Inspect for leakage and repair as necessary. Inspect the dewatering device and ensure discharge is not sediment laden.

To remove the diversion pipe:

1. Inspect the site to determine the practice is no longer needed.
2. Inspect to ensure channel bank stabilization measures have been installed, including seed and mulch or seed and matting, as specified on the plans.
3. Remove the upstream diversion.
4. Remove sediment buildup (if applicable).
5. Remove the culvert and downstream diversion.
6. Restore the stream channel to its original or design cross-section and revegetate area disturbed by practice removal as per the planting plan.

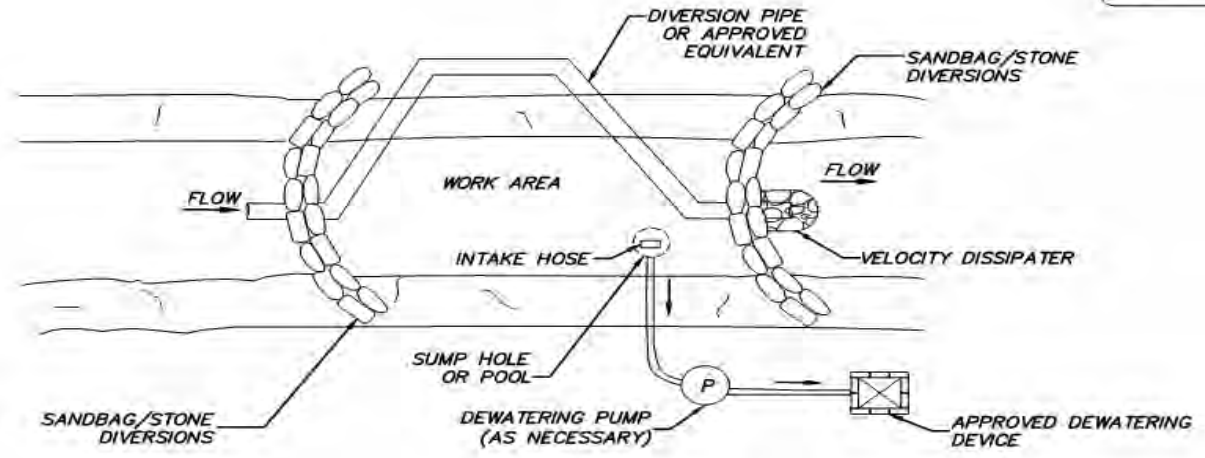
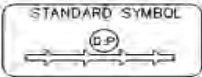

**PLAN VIEW**

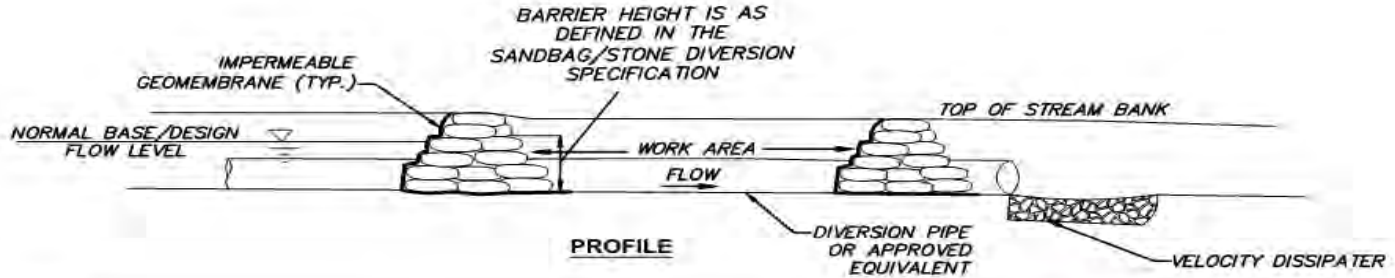

**PROFILE**

DATE	APPR	
REVISED		
ISSUED:		
	REFERENCE	

**DIVERSION PIPE-1**

 DISTRICT OF COLUMBIA  
 DEPARTMENT OF ENERGY &  
 ENVIRONMENT

DWG. NO 810.1

SOURCE: 2011 MARYLAND STANDARDS & SPECIFICATIONS

Detail 60 – 810.1 Diversion Pipe - 1

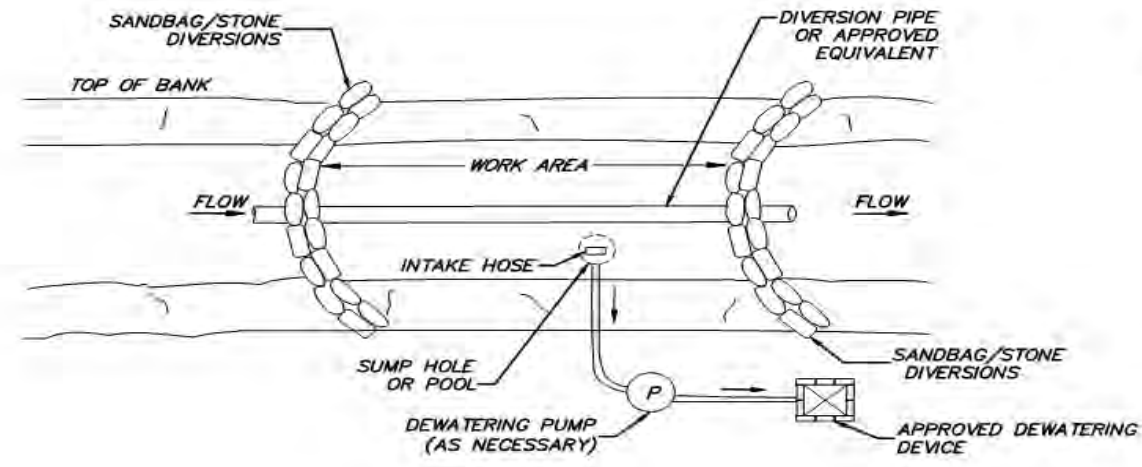
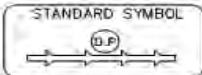

PLAN VIEW

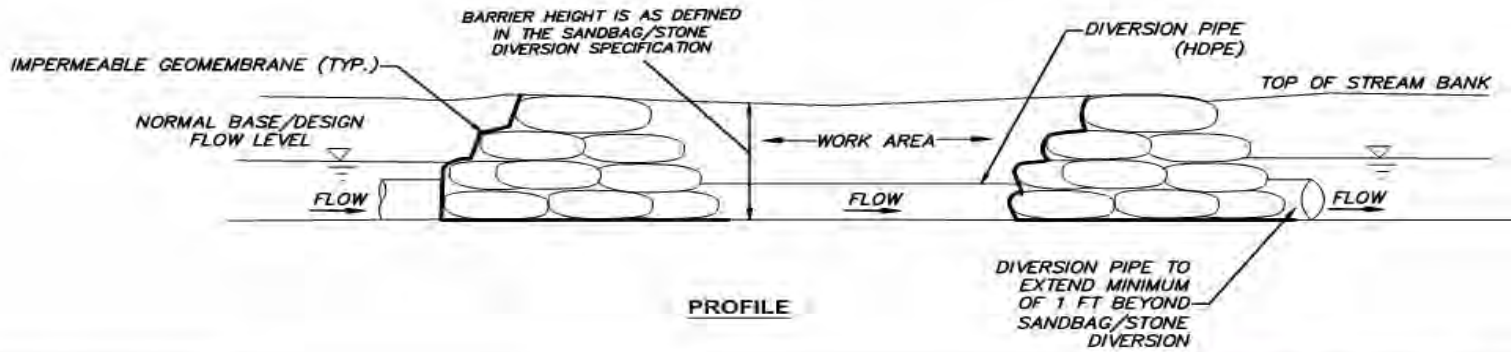

PROFILE

DATE	APPR	
REVISED		
ISSUED:		
	REFERENCE	

**DIVERSION PIPE- 2**

★ ★ ★ DISTRICT OF COLUMBIA  
 DEPARTMENT OF ENERGY &  
 ENVIRONMENT

DWG. NO 810.2

SOURCE: 2011 MARYLAND STANDARDS & SPECIFICATIONS

Detail 61 – 810.2 Diversion Pipe - 2

## 8.11 Slotted Pipe Diversion

### 8.11.1 Definition

Temporary dewatering practice that diverts water into a pipe and dewatering basin for a segment of the stream to allow for in-channel construction.

### 8.11.2 Purpose

To divert flow around sections or reaches of the stream using a temporary pipe with a slotted orifice in combination with additional support measures, such as sandbag or stone diversions, a sediment trap or basin, and a dewatering basin when construction activities need to occur in the stream channel. The intercepted water from the work area is discharged to an acceptable dewatering practice.

### 8.11.3 Conditions Where Practice Applies

A slotted diversion pipe is appropriate if the following apply:

- Construction activities require that a reach of the stream be dewatered and maintained in a dry condition.
- In-stream construction comprised of practices that will span the entire width of the stream are installed.
- The flow required to be diverted can be accomplished without pumping.
- There is a positive slope to allow flow through the pipes.
- Diversion pipe, pump-around, or channel diversion practices will not function due to site constraints.
- There is sufficient space in the stream corridor for appropriately sized sediment traps or basins.

Consider the following limitations before using a diversion pipe:

- Due to stability issues, equipment cannot be driven over pipes. If there is a possibility of the pipes being driven over by construction equipment, use Section 8.2 Temporary Access Stream Crossings.
- Diversion pipes must be able to convey base flow.
- Diversion pipes are difficult to use for grade control structures which span the entire channel.
- After installation, apparatus is difficult to adjust or move without completely removing.
- Diversion pipes with an insufficient flow capacity can cause the channel diversion to fail, thereby resulting in severe erosion of the disturbed channel section under construction. Therefore, conduct in-channel construction activities only during periods of low flow.
- Undersized dewatering basins will not adequately filter sediment-laden water from the construction site.

#### 8.11.4 Design Criteria

The following design criteria apply:

- Use high density polyethylene pipe (HDPE) pipe or equivalent of appropriate thickness and diameter to accomplish diversion of stream flow.
- Pipe and orifice must have a minimum capacity sufficient to convey the stream's base flow for projects with a duration of 2 weeks or less. For projects of longer duration, culverts must have a capacity sufficient to convey the 2-year flow without overtopping.
- Filter cloth must be a woven or non-woven fabric consisting only of continuous chain polymeric filaments or yarns of polyester. The fabric opening size must be sufficient to pass base flow. The fabric must be inert to commonly encountered chemicals, hydro-carbons, ultraviolet light, and mildew and must be rot resistant.
- The in-stream diversion must be either riprap and stone of mixed sizes to minimize void space or sandbags. Sandbags may be filled on site or prefilled and made of burlap or polypropylene materials that are resistant to ultraviolet radiation, tearing, and puncture and must be woven tightly enough to prevent leakage of the fill material (i.e., sand, fine gravel, etc.).
- The height of in-stream diversions must be the normal base flow/design depth plus a minimum 1 foot of freeboard for sandbag/stone diversions that will be installed and removed in the same workday.
- The height of sandbag/stone diversions for a continuous pump-around must be a minimum height of 2 feet.
- In very small channels where the depth of the channel does not exceed 2 feet, the in-stream sandbag/stone diversions must extend to the channel top of bank.
- Pumping equipment can be electric, diesel or gasoline venturi, vacuum, or centrifugal primed pump or equivalent and have appropriately sized intake and discharge pipe/hose with positive restrained joints. Include the necessary pipe connectors and properly store the fuel.
- Dewater using the Section 8.19 Dewatering Basin specification or Section 7.4 Pumped Water Filter Bag specification and manufacturer's specifications.
- Impermeable geomembrane must consist of polyethylene or other material that is impervious and resistant to puncture and tearing.
- Adhere to the design criteria for Section 8.13 Sandbag/Stone Channel Diversion for in-stream diversions.
- Follow the specifications in Section 6.1 Sediment Traps or Section 6.2 Sediment Basins.

#### 8.11.5 Construction Specifications

Use the following sequencing for implementation of a diversion pipe:

1. Implement all erosion and sediment control devices, including mandatory dewatering basins, prior to installing the slotted pipe. Installation must proceed during low flow conditions.



2. Situate sandbag/stone diversions or other approved diversions at the upstream and downstream ends of the work area as shown on the plans, and divert stream flow around the work area.
3. Install the impermeable geomembrane by placing the bottom course of sandbags or riprap on top of at least 1 foot of the geomembrane. Extend the geomembrane along the upstream face of the diversion and cover the downstream portion with at least an 18-inch overlap.
4. Deposit and stabilize all excavated material in an approved area outside the 100-year floodplain, unless otherwise authorized.
5. Install pipe to convey the stream flow to approved sediment trap or basin.
6. Fit the pipe orifice with filter cloth to prevent accumulation of bed material or capture of aquatic organisms.
7. Install the pipe perpendicular to stream flow and with the top of pipe at a maximum of 3 inches above the stream bed elevation.
8. Discharge the pipe to an approved sediment basin or trap at an elevation equivalent with the emergency spillway invert.
9. Provide velocity dissipation measures at the diversion culvert's outlet to prevent stream bed scour. If riprap is utilized, size it according to Section 5.1 Rock Outlet Protection.
10. Pump sediment-laden water from the construction area to an approved dewatering device.

#### **8.11.6 Maintenance**

During construction, periodically inspect diversion pipe during the work week. Ensure flow is adequately diverted. Inspect for leakage and repair as necessary. Maintenance of additional support measures must occur per respective standard and specification. Inspect discharge point for erosion. Place additional riprap as necessary.

To remove the slotted pipe diversion:

1. Inspect site to determine practice is no longer needed.
2. Inspect to ensure channel bank stabilization measures have been installed including seed and mulch or seed and matting as specified on the plans.
3. Remove upstream diversion.
4. Remove sediment buildup (if applicable).
5. Remove culvert and downstream diversion.
6. Restore stream channel to its original or design cross-section and re-vegetate area disturbed by practice removal as per the planting plan.

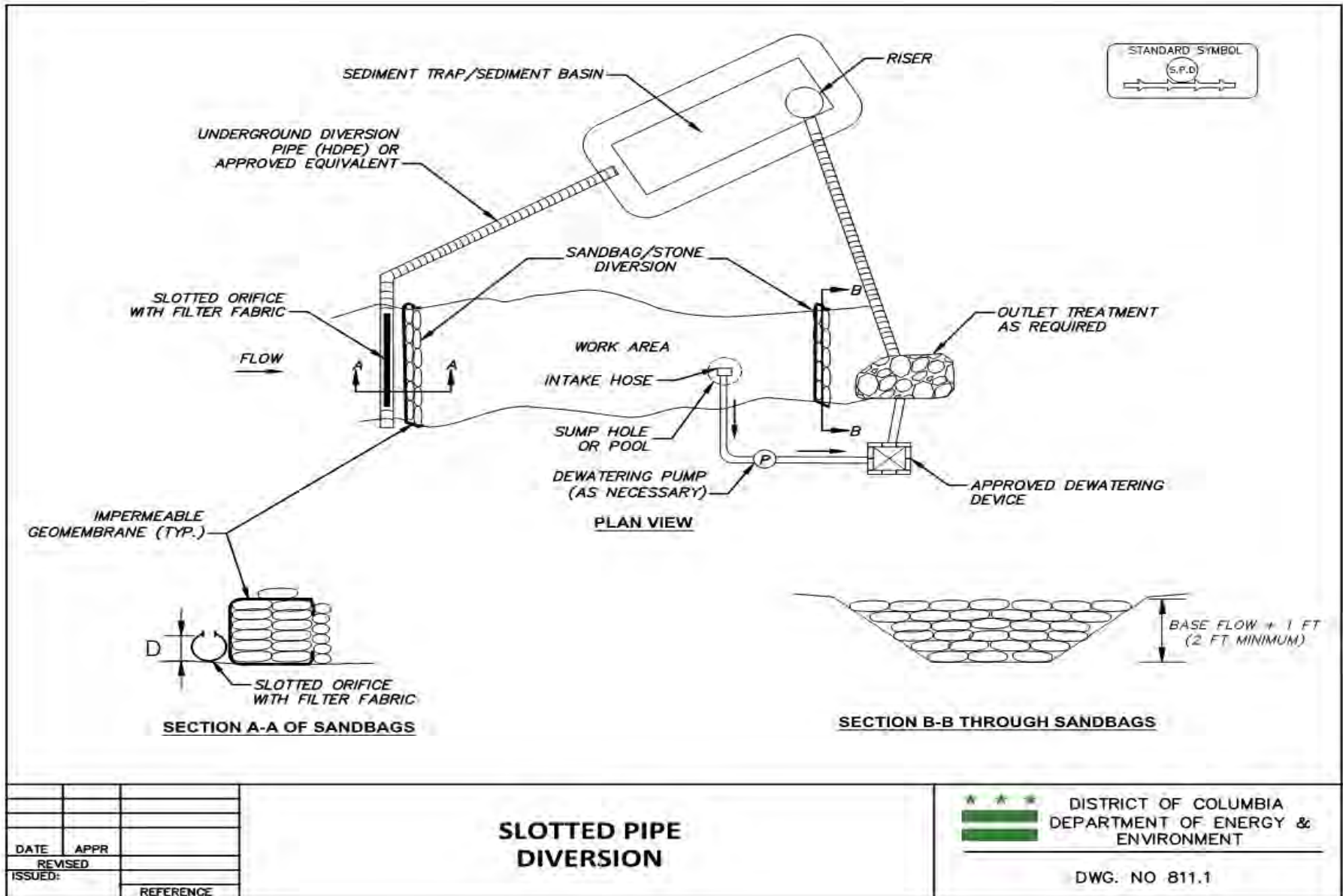

Detail 62 – 811.1 Slotted Pipe Diversion

## 8.12 Temporary Channel Diversion

### 8.12.1 Definition

Temporary dewatering practice that diverts water flow around a segment of the stream during in-channel construction.

### 8.12.2 Purpose

To divert flow around sections or reaches of stream using diversion channels with fabric lining in combination with additional support measures, such as sandbag or stone diversions when construction activities need to occur in the stream channel. The intercepted water from the work area is discharged to an acceptable dewatering practice.

### 8.12.3 Conditions Where Practice Applies

A temporary channel diversion is appropriate if:

- Construction activities require that a segment of stream be temporarily dewatered.
- The stream corridor can accommodate construction of a channel diversion without significant impact to riparian area.
- Diversions have sufficient capacity to convey design storm for anticipated duration of active diversion. If diversions have an insufficient flow capacity, they can fail and severely erode the disturbed channel section under construction.

Consider the following limitations before installation:

- A diversion channel cannot easily be adjusted or moved when properly installed.
- A diversion channel may reduce equipment access and maneuverability to in-stream work area.
- May not be practical in large channels.
- Requires a positive slope to allow flow through channel.
- Requires a sufficient area to construct the diversion channel.

### 8.12.4 Design Criteria

Use the following design criteria:

- Bottom width of a temporary diversion channel should approximate the bottom width of the natural stream channel.
- The channel must have a minimum capacity sufficient to convey the 1-year flow for projects with duration of 2 weeks or less. For projects of longer duration, channels must have a capacity sufficient to convey the 2-year flow.

- Filter cloth must be a woven or non-woven fabric consisting only of continuous chain polymeric filaments or yarns of polyester. The fabric must be inert to commonly encountered chemicals, hydro-carbons, ultraviolet light, and mildew, and must be rot resistant.
- Anchor pins must have a minimum length of 18 inches and accompanying washers must have a minimum diameter of 1-inch.
- The height of in-stream diversions must be the normal base flow/design depth plus a minimum 1 foot of freeboard for sandbag/stone diversions that will be installed and removed in the same workday.
- The height of sandbag/stone diversions for a continuous pump-around must be a minimum height of 2 feet.
- In very small channels where the depth of the channel does not exceed 2 feet, extend the in-sandbag/stone diversions to the channel top of bank.
- Pumping equipment can be electric, diesel or gasoline venturi, vacuum, or centrifugal primed pump or equivalent and have appropriately sized intake and discharge pipe/hose with positive restrained joints. Include the necessary pipe connectors and properly store the fuel.
- Dewater using the Section 8.19 Dewatering Basin specification or Section 7.4 Pumped Water Filter Bag specification and manufacturer's specifications.
- Follow the specifications in Section 5.1 Rock Outlet Protection or Section 5.2 Plunge Pool/Stilling Basin for non-erosive velocity discharge dissipation.
- Size the riprap or sandbags to resist the 1-year flow if the duration of the project is less than 2 weeks. Otherwise, design them to resist the 2-year flow.
- Riprap must be washed and have a minimum diameter of 6 inches.
- The in-stream diversion must be either riprap and stone of mixed sizes to minimize void space or sandbags. Sandbags may be filled on site or prefilled and made of burlap or polypropylene materials that are resistant to ultraviolet radiation, tearing, and puncture and must be woven tightly enough to prevent leakage of the fill material (i.e., sand, fine gravel, etc.).
- Impermeable geomembrane must consist of polyethylene or other material that is impervious and resistant to puncture and tearing.
- Adhere to the design criteria for Section 8.13 Sandbag/Stone Channel Diversion for in-stream diversions.

#### **8.12.5 Construction Specifications**

Construction of fabric-based channel diversions involves channel excavation, placement of geotextile fabric, and installation of flow sandbag/stone diversions for both the main channel and all tributaries contributing flow to the work area.

##### Channel Excavation

1. Stockpile all excavated materials outside of the 100-year flood plain if possible and temporarily stabilize to prevent reentry into the stream channel.

2. Excavate and stabilize with fabric as a continuous and uninterrupted operation. Have all materials on-site prior to channel construction.
3. Construct the downstream and upstream connection to the natural channel under low flow conditions.
4. Construct the temporary diversion channel from downstream to upstream.
5. Install the upstream sandbag/stone diversion followed by the downstream diversion.
6. Contain the stream with sandbags along the opposing bank during the process of cutting the diversion channel into the natural stream channel. Excavate and stabilize as a continuous and uninterrupted operation.
7. Remove all debris such as rocks, sticks, etc. and smooth the channel surfaces so that the fabric will rest flush with the channel at all sides and bottom.

#### Stabilization with Geotextile Fabric

1. The fabric should have a minimum width such that it is keyed in and anchored at the top of stream bank.
2. Place fabric so that it rests flush with the channel at all points of contact.
3. Place fabric such that one piece will line the entire channel. If this is not possible, place fabric so that transverse overlapping occurs in accordance with the detail. Longitudinal overlaps are not allowed. Upstream sections must overlap downstream sections. The overlap width must be a minimum of 2 feet.
4. Key the fabric into 2-foot by 2-foot trenches located at the upstream edge and at 50-foot intervals with the overlap placed nearest to each 50-foot increment. The key-in must be from top of channel to top of channel.
5. Secure the fabric sections with anchor pins and washers. Pin the overlaps along transverse and longitudinal axes with spacing equal to 3 feet maximum.
6. Do not allow sediment from surrounding areas of disturbance to enter the diversion channel.

#### Alternate Methods of Placing the Fabric

1. The above design may be modified to allow sewing of the geotextile fabric. Sewing of the geotextile fabric, rather than overlapping, eliminates the requirement for transverse placement of the fabric. Either transverse or longitudinal placement work equally well.
2. The spacing of the pins could be either larger or smaller depending on the anticipated velocities and thickness and type of geotextile fabric.
3. The entire bottom of the channel could be riprapped if high velocities are anticipated. When the area is riprapped, it is not required that the geotextile fabric underneath the riprap be pinned.

### 8.12.6 Maintenance

During construction, inspect the in-stream barrier for leakage and repair as necessary. Periodically inspect fabric to ensure the pins are holding and repair as necessary. Inspect dewatering device and ensure discharge is not sediment laden and that the discharge point is not eroding.

To remove the temporary channel diversion:

1. Inspect site to determine practice is no longer needed.
2. Inspect to ensure channel bank stabilization measures have been installed including seed and mulch or seed and matting as specified on the plans.
3. Remove upstream sandbag/stone diversion.
4. Remove sediment buildup (if applicable).
5. Remove downstream sandbag/stone diversion.
6. After redirecting the flow through the natural channel, remove all fabric from the temporary diversion. Backfill and stabilize the diversion. Protect the points of tie-in to the natural channel with riprap according to the riprap guidelines.
7. Revegetate area disturbed by practice removal (if applicable).

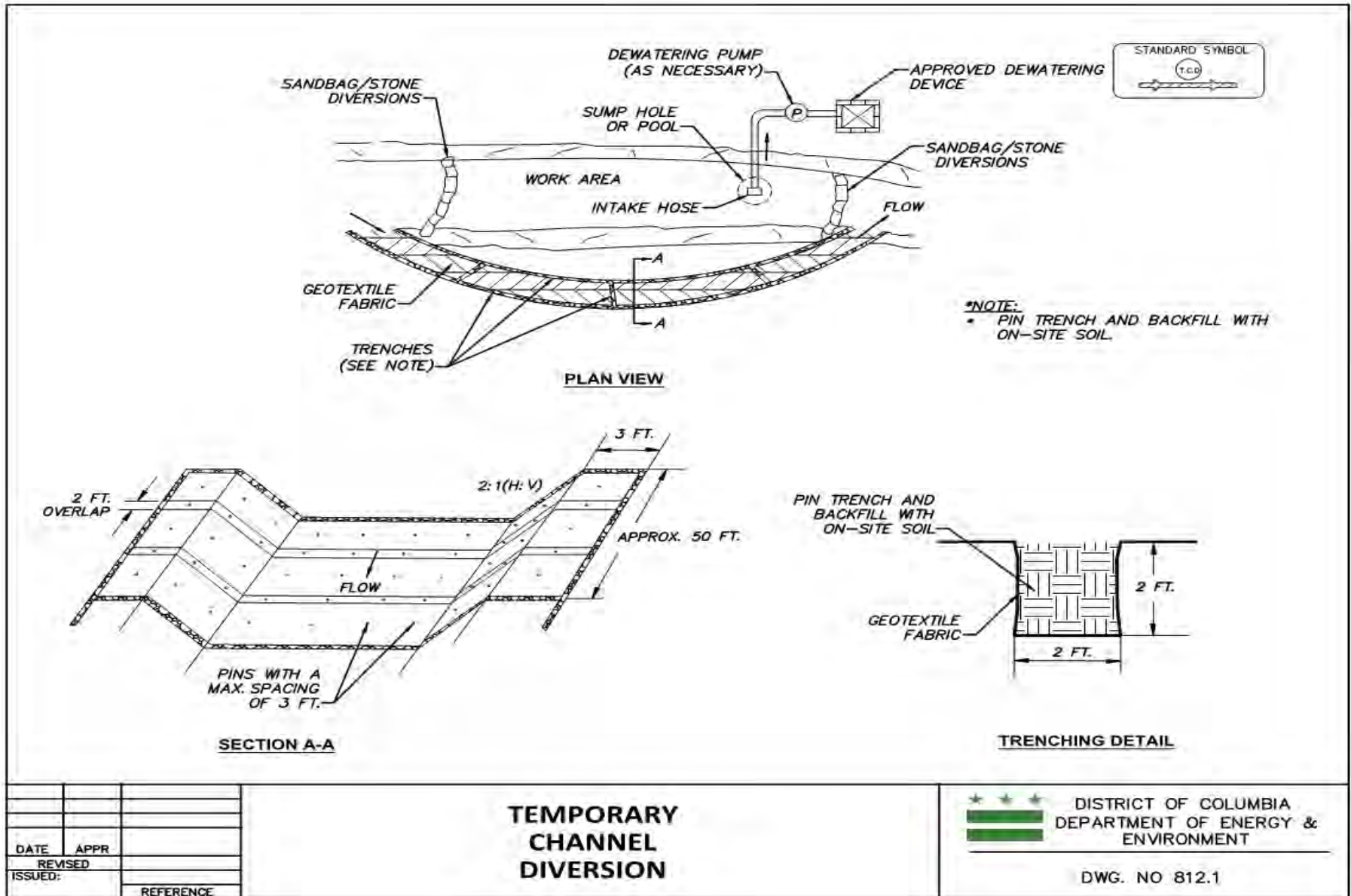

Detail 63 – 812.1 Temporary Channel Diversion

## **8.13 Sandbag/Stone Channel Diversion**

### **8.13.1 Definition**

Dewatering practice for temporarily diverting stream flow around a portion of a stream's width during in-channel construction.

### **8.13.2 Purpose**

To divert flow around an area of the stream and provide dry conditions during construction by installing an impervious diversion in a portion of the stream channel.

### **8.13.3 Conditions Where Practice Applies**

Sandbag/stone diversion is appropriate for the following conditions:

- When installing stream practices that require diverting flow around an area of the streambank and a portion of the stream bed to maintain workable conditions.
- To enhance construction conditions to repair small, localized areas of bank failure or implement bank stabilization/protection measures.
- For use in ditches, streams, channels, swales, and excavations. Diversion may not be appropriate for larger streams.

Consider the following limitations before choosing sandbag/stone channel diversion:

- Results in smaller area of stream access compared to other temporary in-stream construction methods.
- May fail and erode during storm events.
- For large channels, Section 8.15 Portable Dams/Barriers may be more suitable.

### **8.13.4 Design Criteria**

The following design criteria apply:

- Height of in-stream diversions must be the normal base flow/design depth plus a minimum 1 foot of freeboard for sandbag/stone diversions that will be installed and removed in the same workday.
- Height of sandbag/stone diversions for a continuous pump-around must be a minimum height of 2 feet.
- In very small channels where the depth of the channel does not exceed 2 feet, extend the in-stream sandbag/stone diversions to the channel top of bank.
- Pumping equipment can be electric, diesel or gasoline venturi, vacuum, or centrifugal primed pump or equivalent and have appropriately sized intake and discharge pipe/hose with positive restrained joints. Include the necessary pipe connectors and properly store the fuel.



- Dewater using the Section 8.19 Dewatering Basin specification or Section 7.4 Pumped Water Filter Bag specification and manufacturer's specifications.
- Follow the specifications in Section 5.1 Rock Outlet Protection or Section 5.2 Plunge Pool/Stilling Basin for non-erosive velocity discharge dissipation.
- Size the riprap or sandbags to resist the 1-year flow if the duration of the project is less than 2 weeks. Otherwise, design them to resist the 2-year flow.
- Riprap must be washed and have a minimum diameter of 6 inches.
- The in-stream diversion must be either riprap and stone of mixed sizes to minimize void space or sandbags. Sandbags may be filled on site or prefilled and made of burlap or polypropylene materials that are resistant to ultraviolet radiation, tearing, and puncture and must be woven tightly enough to prevent leakage of the fill material (i.e., sand, fine gravel, etc.).
- Impermeable geomembrane must consist of polyethylene or other material that is impervious and resistant to puncture and tearing.

### **8.13.5 Construction Specifications**

Use the following sequencing for implementation of the sandbag/stone diversion:

1. Implement all erosion and sediment control devices including mandatory dewatering devices prior to sandbag/stone diversion construction. Install during low flow conditions.
2. Situate sandbag dikes or other approved diversion at the upstream and downstream ends of the work area as shown on the plans, and divert stream flow around the work area.
3. Do not allow sandbag/stone diversions to obstruct more than 45% of a stream's width if being utilized to isolate one side of a stream bank in a large channel. Additionally, place bank stabilization measures in the constricted section if accelerated erosion and bank scour are observed during the construction time or if project time is expected to last more than 2 weeks.
4. Install the impermeable geomembrane by placing the bottom course of sandbags or riprap on top of at least 1 foot of the geomembrane. Extend the geomembrane along the upstream face of the diversion and cover the downstream portion with at least an 18-inch overlap.
5. Deposit all excavated material from the work area and stabilize in an approved area outside the 100-year floodplain unless otherwise authorized.
6. Pump sediment-laden water from the construction area to a dewatering basin.

### **8.13.6 Maintenance**

During construction, inspect in-stream diversion daily during the work week for leakage and repair as necessary.

To remove the sandbag/stone channel diversion:

1. Inspect site to determine practice is no longer needed.
2. Inspect to ensure channel bank stabilization measures have been installed including seed and mulch or seed and matting as specified on the plans.
3. Remove sediment buildup (if applicable).
4. Remove sandbag or stone diversion.
5. Restore stream channel to its original or design cross-section and revegetate area disturbed by practice removal as per the planting plan.

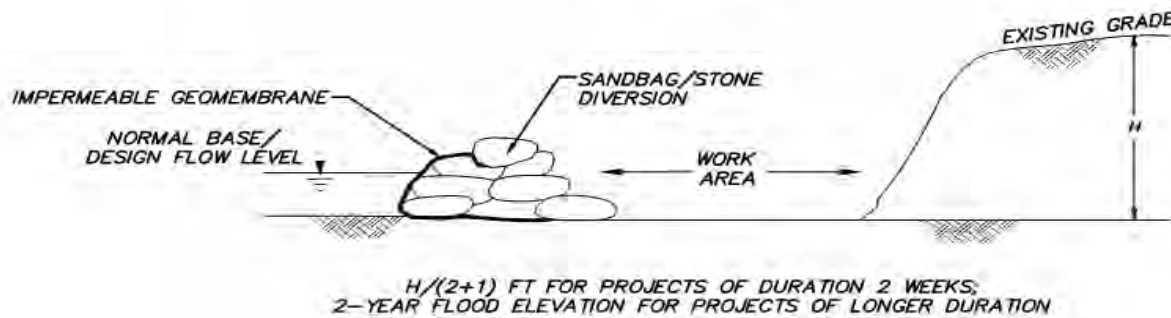
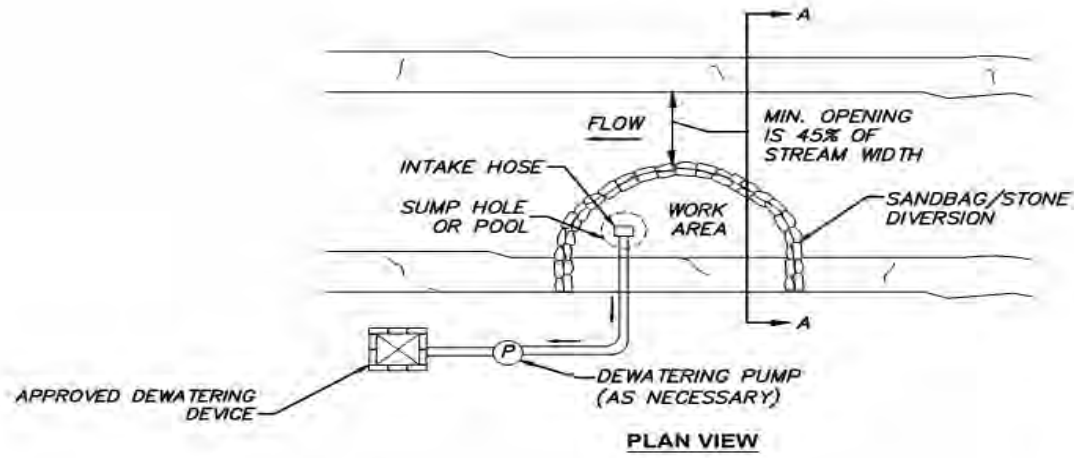

DATE	APPR	
REVISED		
ISSUED:		
	REFERENCE	

## SANDBAG/STONE CHANNEL DIVERSION

\*\*\* DISTRICT OF COLUMBIA  
DEPARTMENT OF ENERGY &  
ENVIRONMENT

DWG. NO 813.1

(SOURCE: 2011 MARYLAND STANDARDS & SPECIFICATIONS)

## 8.14 Turbidity Curtain

### 8.14.1 Definition

A floating geotextile material which minimizes sediment transport from a disturbed area adjacent to or within a body of water.

### 8.14.2 Purpose

To provide sedimentation protection for a watercourse from up-slope land disturbance or from dredging or filling within the watercourse.

### 8.14.3 Conditions Where Practice Applies

Turbidity curtain is applicable at non-tidal and tidal watercourses where intrusion into the watercourse by construction activities and subsequent sediment movement is unavoidable. A turbidity curtain is designed to deflect and contain sediment within a limited area and provide enough residence time so that soil particles will fall out of suspension and not travel to other areas. Turbidity curtains must be used when using anchored barges or boats, or any anchored equipment, and when conducting pile installation, pile removal, or soil boring work in the watercourse.

Consider the following limitations when using turbidity curtains:

- Turbidity curtain types must be selected based on the flow conditions within the waterbody—whether it be a flowing channel, lake, pond, or a tidal watercourse. The specifications contained within this practice pertain to minimal and moderate flow conditions where the velocity of flow may reach 5 feet per second (or a current of approximately 3 knots). For situations where there are greater flow velocities or currents, consult a qualified engineer and product manufacturer.
- Consideration must also be given to the direction of water movement in channel flow situations. Turbidity curtains are not designed to act as water impoundment dams and cannot be expected to stop the flow of a significant volume of water. They are designed and installed to trap sediment, not to halt the movement of the water itself. In most situations, turbidity curtains should not be installed across channel flows.

### 8.14.4 Design Criteria

The following design criteria apply:

- Use Type I configuration (see Detail 814.1) in protected areas where there is no current and the area is sheltered from wind and waves.
- Use Type II configuration (see Detail 814.1) in areas where there may be small to moderate current running (up to 2 knots or 3.5 feet per second) and/or wind and wave action can affect the curtain.

- Use Type III configuration (see Detail 814.2) in areas where considerable current (up to 3 knots or 5 feet per second) may be present, where tidal action may be present, and/or where the curtain is potentially subject to wind and wave action.
- When sizing the length of the floating curtain, allow an additional 10% to 20% variance in the straight-line measurements. This will allow for measuring errors, make installing easier, and reduce stress from potential wave action during high winds.
- Barriers should be a bright color (yellow or orange are recommended) that will attract the attention of nearby boaters.
- The curtain fabric must meet the minimum requirements noted in Table 8.1 below.
- Seams in the fabric must be either vulcanized welded or sewn, and must develop the full strength of the fabric.
- Floatation devices must be flexible, buoyant units contained in an individual floatation sleeve or collar attached to the curtain. Buoyancy provided by the floatation units must be sufficient to support the weight of the curtain and maintain a freeboard of at least 3 inches above the water surface level.
- Load lines must be fabricated into the bottom of all floating turbidity curtains. The top load line must consist of woven webbing or vinyl-sheathed steel cable and have a break strength in excess of 10,000 pounds. The supplemental (bottom) load line must consist of a chain incorporated into the bottom hem of the curtain of sufficient weight to serve as ballast to hold the curtain in a vertical position. Additional anchorage is provided as necessary. The load lines must have suitable connecting devices which develop the full breaking strength for connecting to load lines in adjacent sections (see Details 814.1 and 814.2, which portray this orientation).
- Turbidity curtains must be in place after the equipment is brought into the work area but before it is anchored.

**Table 8.1 Physical Properties of Turbidity Curtain Fabric**

Physical Property	Requirement
Thickness (millimeters)	45
Weight (ounces per square yard)	
Type I	18
Type II	18 or 22
Type III	22
Grab Tensile Strength, lb	300
UV Inhibitor	Must be included

### 8.14.5 Construction Specifications

Use the following sequencing for implementation of a turbidity curtain:

1. Extend turbidity curtains the entire depth of the watercourse whenever the watercourse in question is not subject to tidal action and/or significant wind and wave forces.
2. In tidal and/or wind and wave action situations, the curtain should never be so long as to touch the bottom. A minimum 1 foot "gap" should exist between the weighted lower end of the skirt and the bottom at "mean" low water. Movement of the lower skirt over the bottom due to tidal reverses or wind and wave action on the flotation system may fan and stir sediments already settled out.
3. In tidal and/or wind and wave action situations, it is seldom practical to extend a turbidity curtain depth lower than 10 to 12 feet below the surface, even in deep water. Curtains which are installed deeper than this will be subject to very large loads with consequent strain on curtain materials and the mooring system. In addition, a curtain installed in such a manner can "billow up" towards the surface under the pressure of the moving water, which will result in an effective depth which is significantly less than the skirt depth.
4. Locate turbidity curtains parallel to the direction of flow of a moving body of water. Do not place turbidity curtains across the main flow of a significant body of moving water.
5. Attempt to avoid an excessive number of joints in the curtain; a minimum continuous span of 50 feet between joints is a good "rule of thumb."
6. For stability reasons, a maximum span of 100 feet between joints (anchor or stake locations) is also a good rule to follow.
7. Extend the ends of the curtain, both floating upper and weighted lower, well up into the shoreline, especially if high water conditions are expected. Secure the ends firmly to the shoreline (preferably to rigid bodies such as trees or piles) to fully enclose the area where sediment may enter the water.
8. When there is a specific need to extend the curtain to the bottom of the watercourse in tidal or moving water conditions, a heavy woven pervious geotextile may be substituted for the normally recommended impermeable geomembrane. This creates a "flow-through" medium that significantly reduces the pressure on the curtain and will help to keep it in the same relative location and shape during the rise and fall of tidal waters.
9. Typical alignments of turbidity curtains are shown in Detail 814.3. The number and spacing of external anchors may vary depending on current velocities and potential wind and wave action; follow manufacturer's recommendations.

### 8.14.6 Maintenance

Allow soil particles to settle for a minimum of 6–12 hours prior to their removal by equipment or prior to removal of a turbidity curtain. During construction, periodically inspect to ensure that fabric is providing continuous protection of the watercourse. Repair as necessary following manufacturer's instructions.

To remove the turbidity curtain:

1. Inspect site to determine practice is no longer needed.
2. When the curtain has served its purpose, remove all components once remaining sediment has sufficiently settled.
3. Remove sediment buildup to the original depth (or plan elevation) (if applicable).
4. Remove practice.
5. Revegetate area disturbed by practice removal (if applicable).

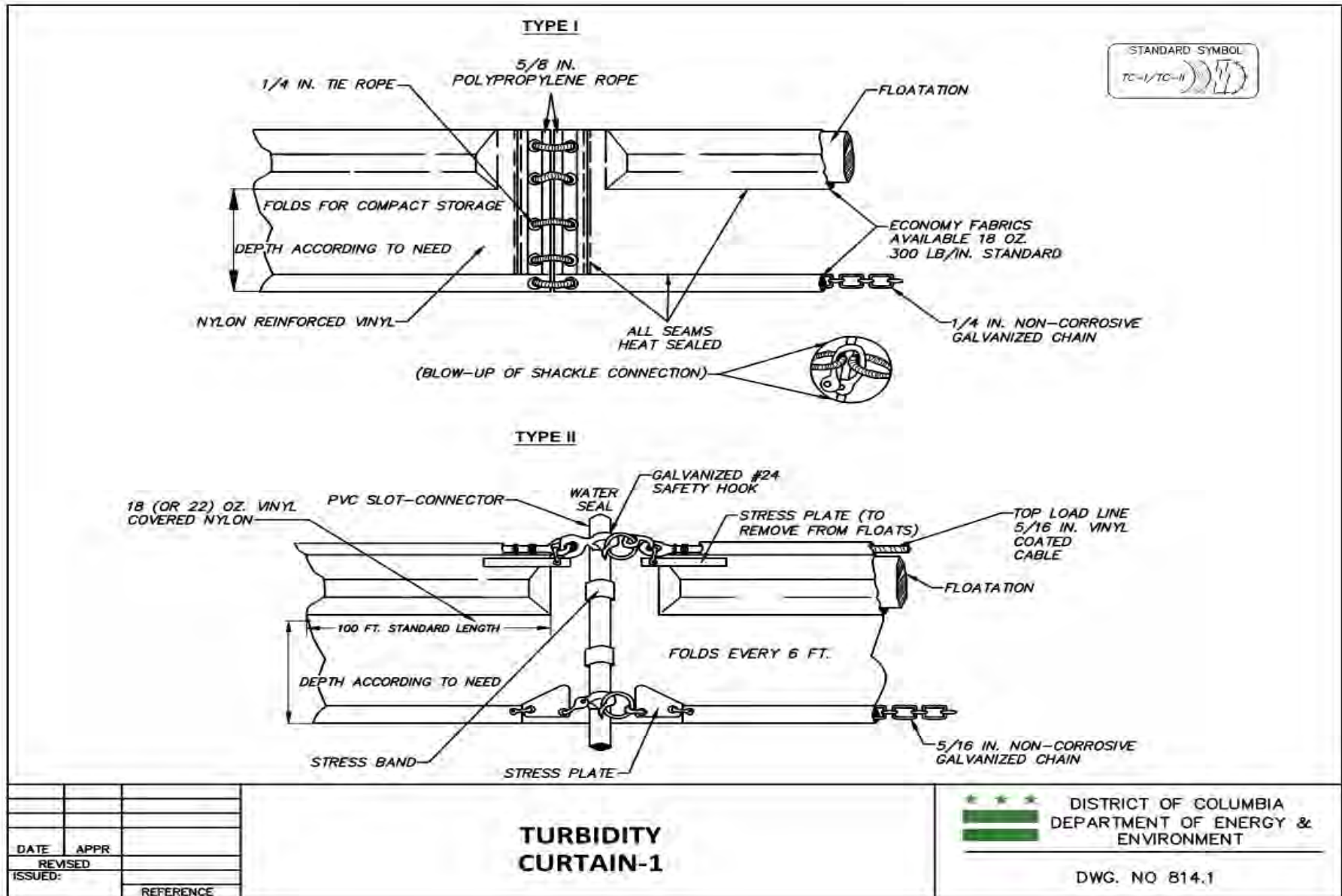

Detail 65 – 814.1 Turbidity Curtain - 1

SOURCE: 2003 DISTRICT OF COLUMBIA SOURCEBOOK



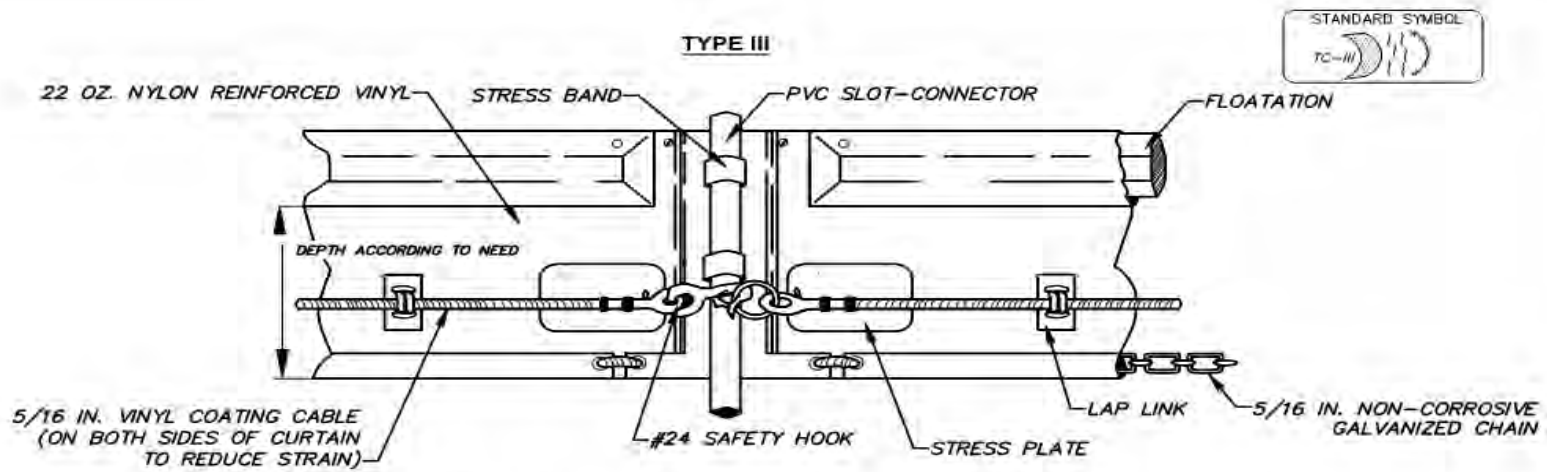

**ORIENTATION WHEN INSTALLED (TIDAL  
SITUATION-TYPE III)**

**NOTE:**

\* ANCHORING WITH BUOYS, AS SHOWN, REMOVES ALL VERTICAL FORCES FROM THE CURTAIN. HENCE, THE CURTAIN WILL NOT SINK FROM WIND OR CURRENT LOADS.

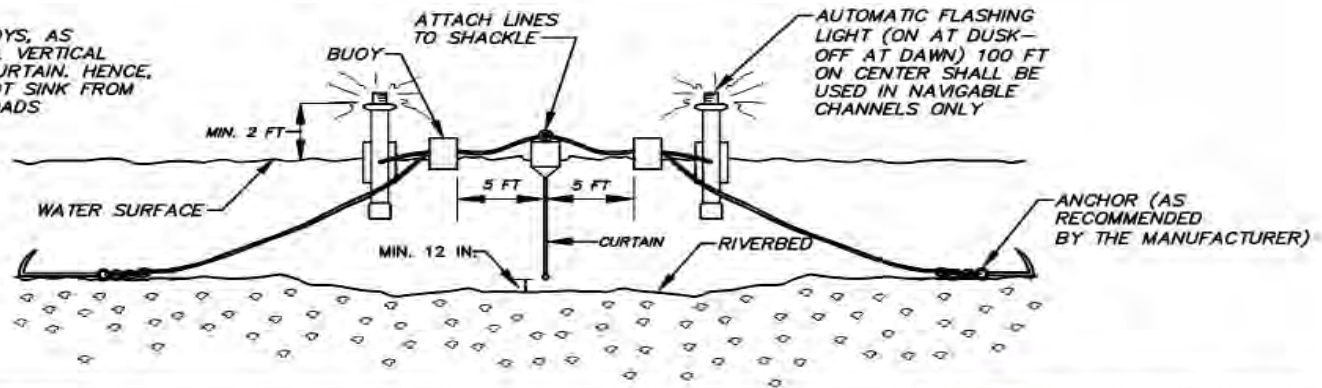

DATE	APPR	
REVISED		
ISSUED:		
	REFERENCE	

**TURBIDITY  
CURTAIN-2**

★ ★ ★ DISTRICT OF COLUMBIA  
DEPARTMENT OF ENERGY &  
ENVIRONMENT

DWG. NO 814.2

SOURCE: 2007 DISTRICT OF COLUMBIA GUIDEBOOK

**TYPICAL LAYOUTS:  
STREAMS, PONDS & LAKES (PROTECTED & NON-TIDAL)**

STANDARD SYMBOL  
N/A

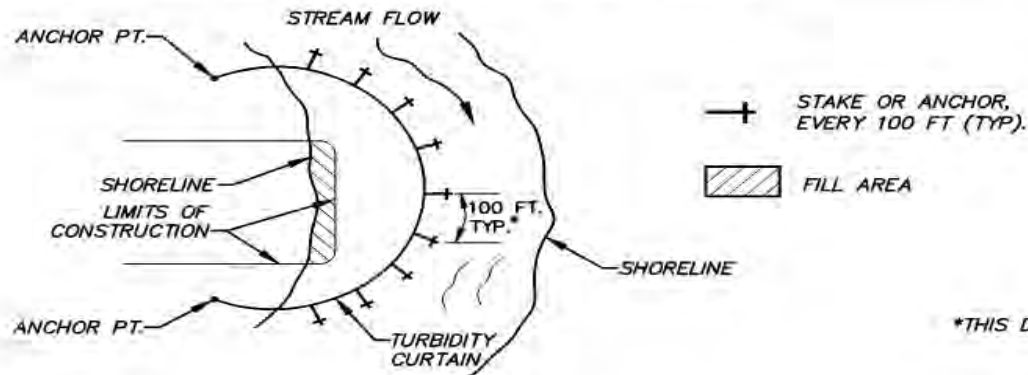

\*THIS DISTANCE IS VARIABLE

**TIDAL WATERS AND/OR HEAVY WIND & WAVE ACTION)**

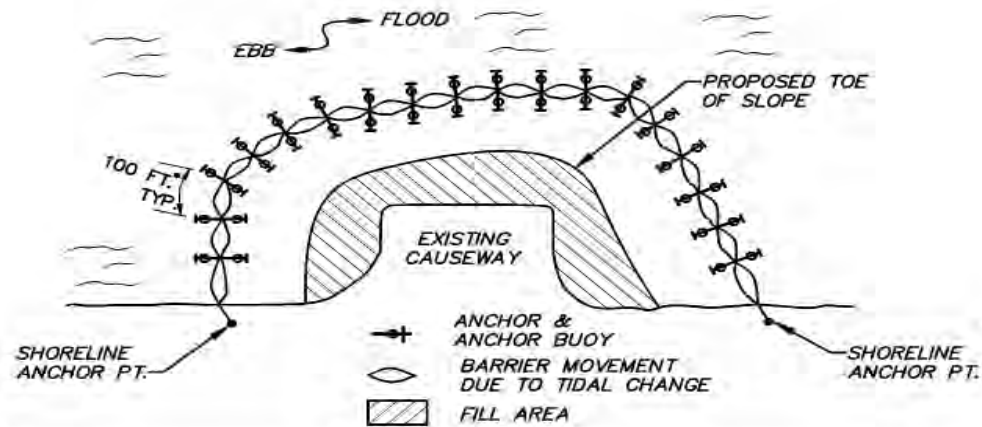

\*THIS DISTANCE IS VARIABLE

DATE	APPR	
ISSUED:		
		REFERENCE

**TURBIDITY  
CURTAIN-3**

★ ★ ★ DISTRICT OF COLUMBIA  
DEPARTMENT OF ENERGY &  
ENVIRONMENT

DWG. NO 814.3

SOURCE: 2003 DISTRICT OF COLUMBIA GUIDEBOOK

Detail 67 – 814.3 Turbidity Curtain - 3

## **8.15 Portable Dams/Barriers**

### **8.15.1 Definition**

Temporary in-stream barriers to divert stream flow around segments of in-channel stream construction.

### **8.15.2 Purpose**

To allow for de-watering of a work area within a stream channel or lake by installing portable stream flow barriers.

### **8.15.3 Conditions Where Practice Applies**

For use in larger rivers, lakes, or along shorelines. Can be used for water depths of 7 plus feet. They can also be used as an alternative to stone and sandbag diversions, based on material availability. Barriers can be difficult to adjust or move when properly installed.

### **8.15.4 Design Criteria**

The following design criteria apply:

- The height of in-stream barriers must be the normal base flow/design depth plus 1 foot of freeboard for diversions that will be installed and removed in the same workday.
- The height of in-stream barriers for a continuous pump around must be the 2-year storm elevation plus 1 foot of freeboard. The minimum in-stream barrier height is 2 feet.
- Modular dams must consist of self-contained impermeable containers per manufacturer's specifications filled with sand.
- The Jersey wall barrier must consist of concrete per manufacturer's specifications covered with polyethylene geomembrane.
- Inflatable dams must consist of self-contained impermeable dams per manufacturer's specifications filled with water.
- Impermeable geomembrane must consist of polyethylene or other material that is impervious and resistant to puncture and tearing.
- Pumping equipment can be electric, diesel or gasoline venturi, vacuum, or centrifugal primed pump or equivalent and have appropriately sized intake and discharge pipe/hose with positive restrained joints. Include the necessary pipe connectors and properly store the fuel.
- Dewater using the Section 8.19 Dewatering Basin specification or Section 7.4 Pumped Water Filter Bag specification and manufacturer's specifications.

### **8.15.5 Construction Specifications**

Use the following sequencing for implementation of portable dams/barriers:

1. Install dams/barriers before any work is done in the stream channel.

2. Extend dam locations beyond (upstream and downstream) area to be disturbed so its placement does not interfere with in-stream construction.
3. Install the impermeable geomembrane by placing the barrier on top of at least 1 foot of the geomembrane. Extend the geomembrane along the upstream face of the barrier and cover the downstream portion with at least an 18-inch overlap.
4. Remove all large debris located within the foundation of the barrier to ensure proper sealing and reduce leakage through the barrier.
5. A de-watering pump is required to handle seepage.
6. Pump water from the work area to a sediment filtering measure such as a dewatering basin, filter bag, or other approved practice. Locate the measure such that water drains back into the channel below the downstream barrier.

#### **8.15.6 Maintenance**

During construction, monitor dams/barriers daily for leakage and repaired as necessary.

To remove the portable dams/barriers:

1. Inspect site to determine practice is no longer needed.
2. Remove sediment buildup to the original depth (or plan elevation) (if applicable).
3. Remove practice.
4. Re-vegetate area disturbed by practice removal (if applicable).





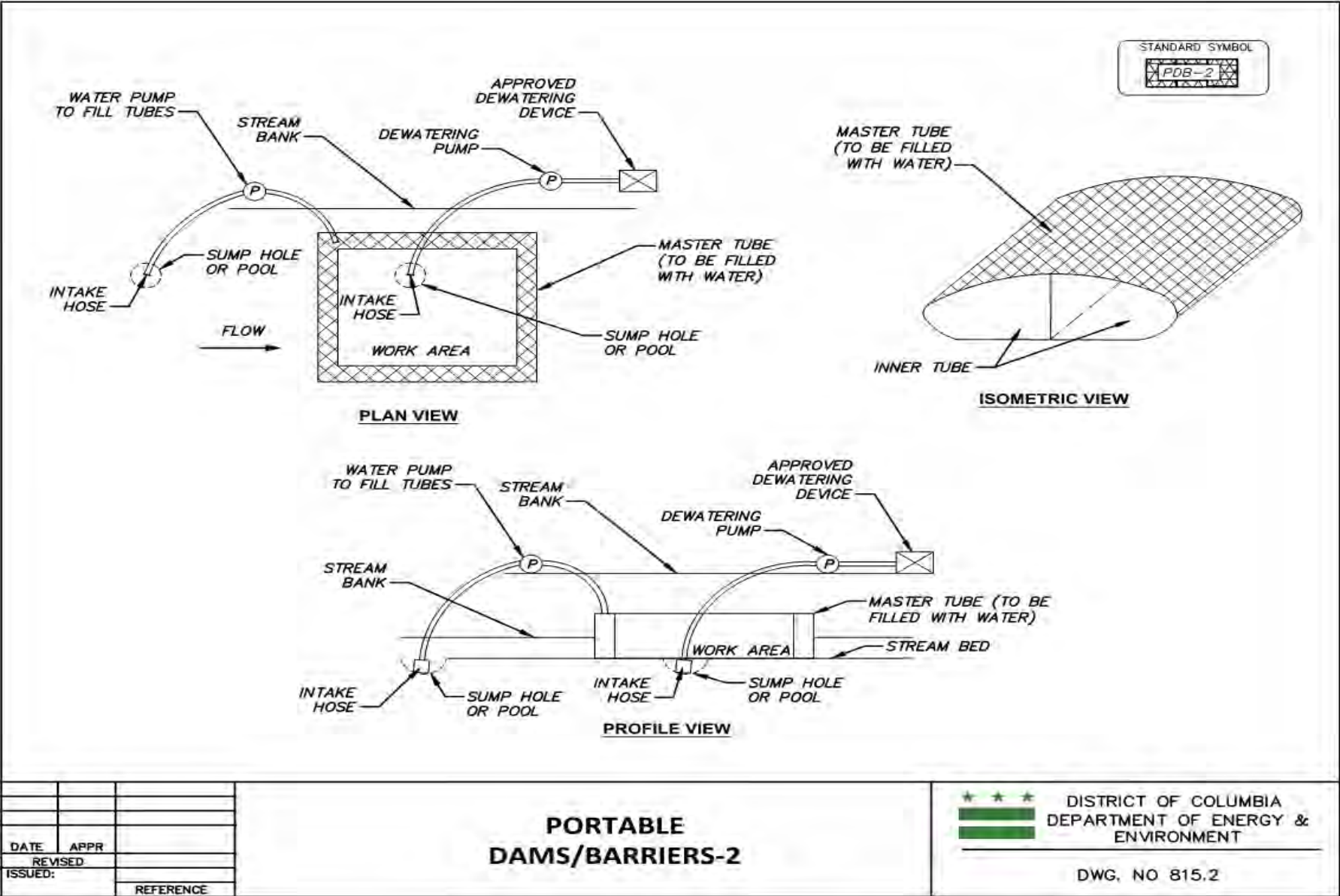

Detail 69 – 815.2 Portable Dams/Barriers - 2

SOURCE: VIRGINIA DEPARTMENT OF CONSERVATION RECREATION

## **8.16 Construction Platform**

### **8.16.1 Definition**

Temporary platform for heavy-equipment mobility during construction along or near the streambank.

### **8.16.2 Purpose**

To allow heavy equipment to work from a temporary platform during construction along or near the streambank in conjunction with turbidity curtains or portable dams.

### **8.16.3 Conditions Where Practice Applies**

Use of a construction platform is appropriate if:

- Construction consists of modifications to the channel bank only.
- Site limitations dictate that work is best conducted from a temporary platform rather than from the channel or from the stream bank. A temporary platform can be an alternative to channel diversions and dewatering.
- Other diversion and dewatering practices are not practical or feasible.
- Construction platforms will typically occur on large rivers and streams with bank heights over 20 feet.

Consider the following limitations before installation:

- Near-bank construction platforms may result in remediation of near-bank environments.
- Installation and removal of construction platforms can be expensive.

### **8.16.4 Design Criteria**

The following design criteria apply:

- Riprap must be washed and have a minimum diameter of 6 inches.
- Portable dam design must conform with specifications in Section 8.15 Portable Dams/Barrier.
- Turbidity curtain design must conform with specifications Section 8.14 Turbidity Curtain.

### **8.16.5 Construction Specifications**

The following are general guidelines:

1. Install portable dams or turbidity curtain to divert flow around proposed work area.
2. Extend the diversion no further than 33% of the channel width.

3. Place Class 1 riprap within the work area in conjunction with temporary pilings as needed. Place a gravel surface that will accommodate the proposed equipment that will be used for the bank construction.

### 8.16.6 Maintenance

Maintain the diversion practice per applicable standard and specification. Inspect the construction platform for settling and geotechnical failure. Repair as needed.

To remove the construction platform:

1. Inspect site to determine practice is no longer needed.
2. Inspect to ensure channel bank stabilization measures have been installed including seed and mulch or seed and matting as specified on the plans. Maintain access road to work area.
3. Remove platform structures and rock.
4. Remove portable dam or turbidity curtain as applicable.
5. Remove access road and restore stream channel to its original or design cross-section and revegetate area disturbed by practice removal as per the planting plan.



**Figure 8.1 Construction platform for major streambank restoration.**  
Source: Inter-Fluve, Inc.



## **8.17 Utility Crossing**

### **8.17.1 Definition**

Temporary measure for installing a utility across a stream.

### **8.17.2 Purpose**

To install erosion control devices in and adjacent to the construction of utility crossings.

### **8.17.3 Conditions Where Practice Applies**

Utility crossing is appropriate if all construction will take place during low stream flow conditions and the duration of construction can be limited to a maximum of 5 consecutive days for each crossing.

Do not install utility lines in actively incising streams without sufficient geomorphic analysis and adequate specification of natural stream channel stabilization practices or other approved methods. Design engineer must provide adequate evidence of the stability or instability of the stream's boundary conditions.

### **8.17.4 Design Criteria**

The following design criteria apply:

- Design criteria must be in conformance with Section 8.9 Culvert Pipe with Access Road or other approved standard and specification.
- Determine the utility crossing location through a geomorphic analysis of the stream pattern, profile, cross-section. Generally, locate utility line crossings within a stable riffle feature and cross the channel perpendicular to stream flow.
- Employ natural channel design (NCD) principles in conjunction with hydraulic and sediment transport analyses to ensure bank and bed treatment is adequate to protect utility line and will not impair stream functioning.
- Where the channel bed is unstable, install sufficient grade-control practices at the upstream and downstream end of the utility line crossing to prevent scour and head-cuts from developing. The design engineer must provide evidence that the grade-control structures are sized appropriately and will not impair stream functioning.
- Where channel cross-section is altered from its original geometry, size the channel according to an approved geomorphic and sediment transport analysis.
- The height of in-stream diversions must be the normal base flow/design depth plus a minimum 1 foot of freeboard for sandbag/stone diversions that will be installed and removed in the same workday.
- The height of sandbag/stone diversions for a continuous pump-around must be a minimum height of 2 feet.

- In very small channels where the depth of the channel does not exceed 2 feet, extend the in-sandbag/stone diversions to the channel top of bank.
- Pumping equipment can be electric, diesel or gasoline venturi, vacuum, or centrifugal primed pump or equivalent and have appropriately sized intake and discharge pipe/hose with positive restrained joints. Include the necessary pipe connectors and properly store the fuel.
- Dewater using the Section 8.19 Dewatering Basin specification or Section 7.4 Pumped Water Filter Bag specification and manufacturer's specifications.
- Follow the specifications in Section 5.1 Rock Outlet Protection or Section 5.2 Plunge Pool/Stilling Basin for non-erosive velocity discharge dissipation.
- Size the riprap or sandbags to resist the 1-year flow if the duration of the project is less than 2 weeks. Otherwise, design them to resist the 2-year flow.
- Riprap must be washed and have a minimum diameter of 6 inches.
- The in-stream diversion must be either riprap and stone of mixed sizes to minimize void space or sandbags. Sandbags may be filled on site or prefilled and made of burlap or polypropylene materials that are resistant to ultraviolet radiation, tearing, and puncture and must be woven tightly enough to prevent leakage of the fill material (i.e., sand, fine gravel, etc.).
- Impermeable geomembrane must consist of polyethylene or other material that is impervious and resistant to puncture and tearing.
- Adhere to the design criteria for Section 8.13 Sandbag/Stone Channel Diversion for in-stream diversions.

### **8.17.5 Construction Specifications**

Use the following sequencing for implementation of the utility crossing:

1. Implement all erosion and sediment control devices, including dewatering basins, prior to utility installation.
2. The contractor must ensure that a continuous perimeter control barrier is in place to minimize the amount of pollutants entering the stream flow.
3. Divert the stream by an approved temporary stream diversion, dewater the construction area, and stabilize any disturbed banks according to the approved geomorphic analysis. The contractor may elect to construct the utility crossing in two stages. In this case, Section 8.13 Sandbag/Stone Channel Diversion or other approved flow diversion may be constructed to keep the construction area dry.
4. Keep excavated topsoil and subsoil separate, placed on the upland side of the excavation, and replaced in their natural order.
5. Place all utility crossings a minimum of 3 feet beneath the stream bed unless an alternative section is specifically approved. For instances where a 3-foot cover is not viable, two alternate stabilization options are given in Detail 817.2. Construct a low flow channel sized according to upstream or downstream functioning reaches of stream or according to an

approved sediment transport and geomorphic analysis through all bed lining across the stream bed. Install upstream and downstream grade-control as designed.

#### **8.17.6 Maintenance**

During construction, inspect in-stream diversion for leakage and repair as necessary. Inspect pump-around practice to ensure flow is adequately diverted through the pump. Inspect for leakage and repair as necessary. Inspect dewatering basin and ensure discharge is not sediment laden. Inspect discharge point for erosion. Repair as necessary. Periodically check the outlet of the culvert to ensure flow is not sediment laden.

To remove the utility crossing:

1. Inspect site to determine practice is no longer needed.
2. Inspect to ensure channel bank stabilization measures have been installed including seed and mulch or seed and matting as specified on the plans.
3. Remove flow diversion.
4. Remove sediment buildup (if applicable).
5. Remove culvert crossing.
6. Restore the stream channel to its original cross-section, and smooth and appropriately stabilize all disturbed areas.
7. Re-vegetate area disturbed by practice removal (if applicable).

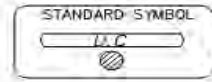
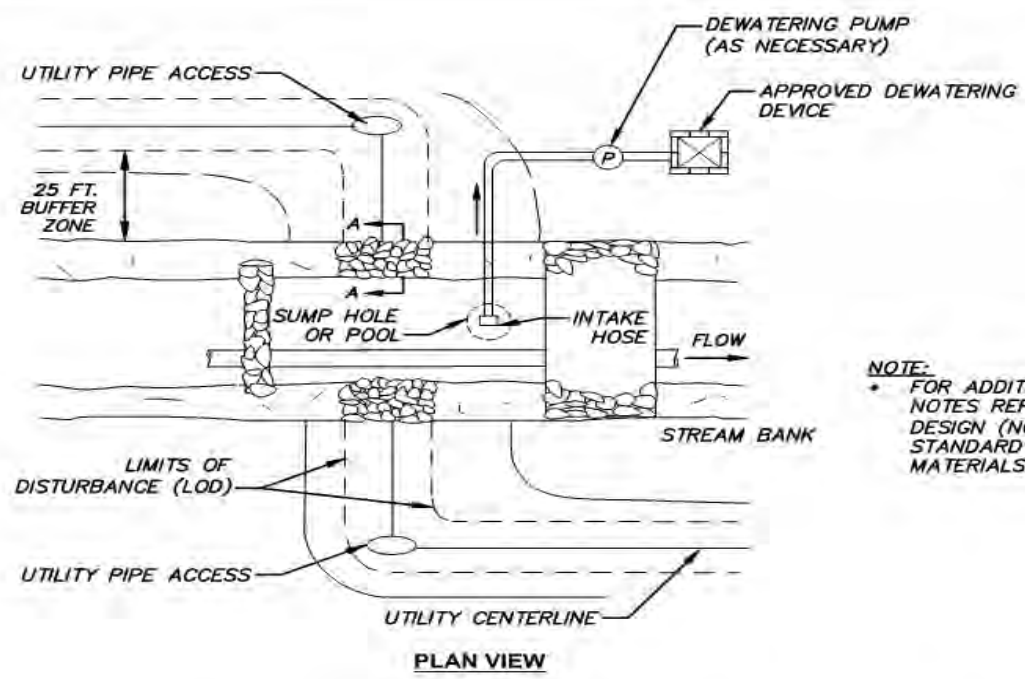

**NOTE:**

- FOR ADDITIONAL BANK PROTECTION NOTES REFER TO NATURAL CHANNEL DESIGN (NCD) FOR GUIDELINES ON STANDARD SIZING AND SPECIFYING MATERIALS.

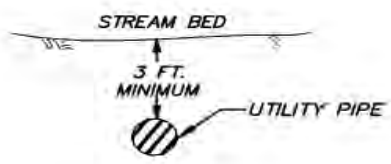
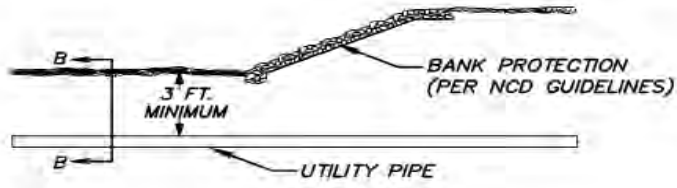

DATE	APPR	
REVISED		
ISSUED:		
	REFERENCE	

### UTILITY CROSSING -1

★ ★ ★ DISTRICT OF COLUMBIA  
 DEPARTMENT OF ENERGY &  
 ENVIRONMENT

DWG. NO 817.1

(SOURCE: 2011 MARYLAND STANDARDS & SPECIFICATIONS)

Detail 70 – 817.1 Utility Crossing - 1



## **8.18 Culvert Installation**

### **8.18.1 Definition**

Permanent installation sequence for culverts.

### **8.18.2 Purpose**

To construct a permanent culvert.

### **8.18.3 Conditions Where Practice Applies**

Use of a culvert is appropriate if a permanent road crossing must be created and a bridge is either not feasible or not appropriate for the specific application.

Consider the following limitations before installation:

- This method illustrates a general sequence of construction and is not suitable for all projects. Therefore, review the construction sequence and modify as necessary to meet specific project needs. Consider selecting a bridge or bottomless arch prior to choosing a culvert.
- Do not install culverts without an approved hydraulic analysis that incorporates sediment transport and fish passage as necessary.

### **8.18.4 Design Criteria**

The following section details a typical installation sequence for culverts and lists the minimum requirements to be incorporated into the project including the applicable erosion and sediment control measures. This standard and specification does not include criteria for the hydraulic design of culverts. Culverts must be designed by a qualified professional and must adhere to all local and federal laws and regulations.

### **8.18.5 Construction Specifications**

Use the following sequencing for implementing culverts:

1. Install a diversion pipe or other measure as specified in Section 8.10 Diversion Pipe and construct a sandbag/stone diversion as specified in Section 8.13 Sandbag/Stone Channel Diversion to divert the streamflow into the diversion practice. Limit in-stream excavation to the amount necessary to allow installation and removal of the standard methods (as in the sections for individual practices) and do not perform excavation within the restricted time periods.
2. Place a sandbag/stone diversion downstream to prevent the flow from backwashing into the construction area.
3. Match the culvert slope to the streambed slope while not exceeding 3%. Depress the culverts when possible to encourage siltation and unobstructed passage of aquatic and semi-aquatic species, including benthic macroinvertebrates.

4. For non-depressed culverts, do not exceed an outfall height of 5 inches and avoid concrete aprons whenever possible.
5. Maintain the stable width/depth ratio of the bank full stage stream channel with the culvert design. Use of elliptical pipe may help attain the proper channel dimension.
6. Construct a low flow channel through the riprap placements across the streambed.
7. Stabilize the disturbed sections of the channel, including the slopes and streambed, with approved methods.
8. Dewater the construction area and remove the temporary stream diversion starting at the downstream section and moving upstream.
9. Finally, restore the dewatering basin(s) to the original grade, remove the silt fence, and seed and mulch all disturbed areas.

#### **8.18.6 Maintenance**

During culvert installation, silt fences may require periodic maintenance. Diversions also require periodic inspection and possible maintenance during construction. See Section 8.13 Sandbag/Stone Channel Diversion for further maintenance specifications.

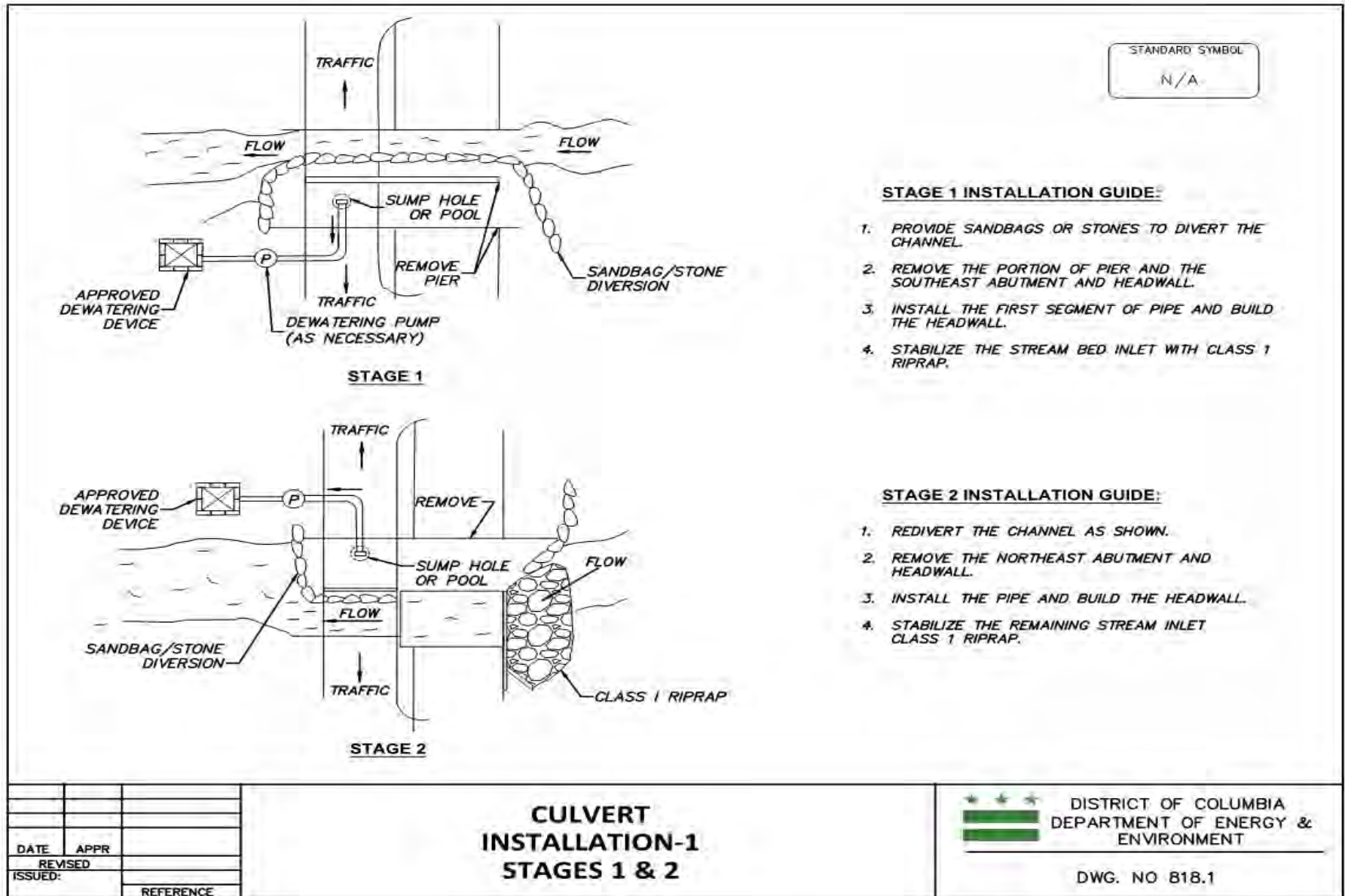

Detail 72 – 818.1 Culvert Installation Stages 1 & 2



STANDARD SYMBOL  
N/A

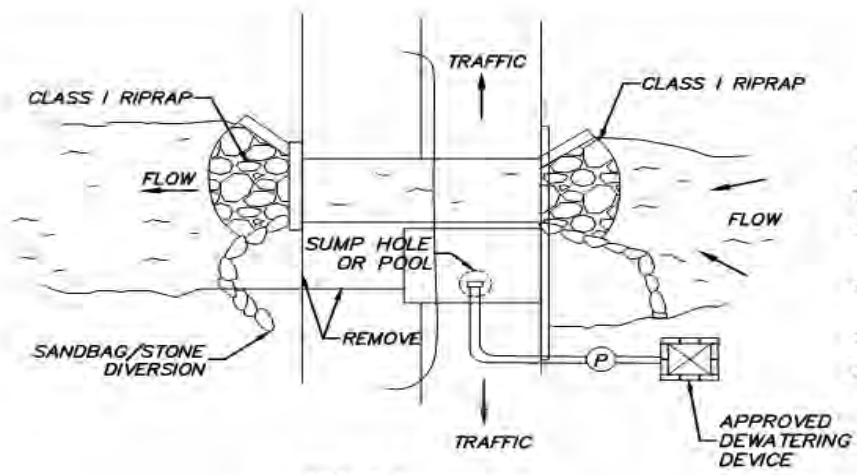

**STAGE 3**

- STAGE 3 INSTALLATION GUIDE:**
1. REDIRECT THE CHANNEL AS SHOWN.
  2. REMOVE THE REMAINING ABUTMENT AND WINGWALL.
  3. BUILD THE LAST PORTION OF PIPE AND HEADWALL.
  4. STABILIZE THE OUTLET WITH RIPRAP.
  5. RESTORE THE ROAD SURFACE.

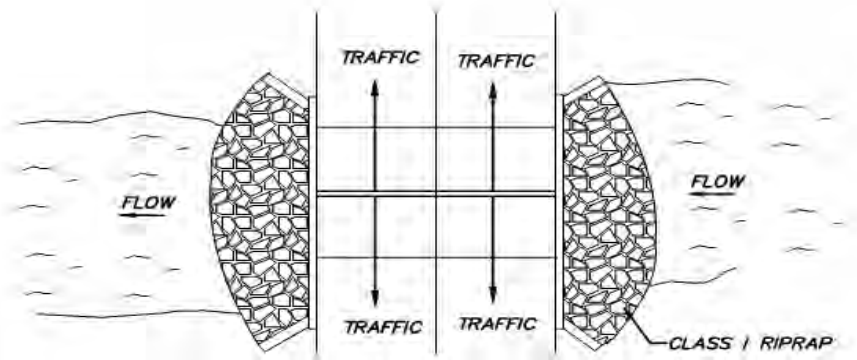

**STAGE 4**

- STAGE 4 INSTALLATION GUIDE:**
1. REMOVE TRAFFIC BARRIERS.
  2. STABILIZE ALL DISTURBED AREAS WITH SEED AND MULCH.
  3. REMOVE SEDIMENT CONTROL DEVICES.

DATE	APPR	
REVISED		
ISSUED:		
	REFERENCE	

**CULVERT  
INSTALLATION-2  
STAGES 3 & 4**

\*\*\* DISTRICT OF COLUMBIA  
DEPARTMENT OF ENERGY &  
ENVIRONMENT

DWG. NO 818.2

SOURCE: 2011 MARYLAND STANDARDS & SPECIFICATIONS

Detail 73 – 818.2 Culvert Installation Stages 3 & 4

## **8.19 Dewatering Basins**

### **8.19.1 Definition**

A temporary measure for filtering sediment-laden water.

### **8.19.2 Purpose**

To filter sediment-laden water from in-stream construction sites or stormwater management facilities before the water reenters the downstream reach.

### **8.19.3 Conditions Where Practice Applies**

Use of a dewatering basin is appropriate for all projects required to filter sediment-laden water from in-stream construction sites before the water reenters the downstream reach.

Undersized dewatering basins will not adequately filter sediment-laden water from the construction site.

### **8.19.4 Design Criteria**

The following design criteria apply:

- Riprap must be washed and have a diameter ranging from 4 to 6 inches.
- Filter cloth must be a woven or non-woven fabric consisting only of continuous chain polymeric filaments or yarns of polyester. The fabric must be inert to commonly encountered chemicals, hydro-carbons, ultraviolet light, and mildew and must be rot resistant.
- Straw bales/silt fence must meet the criteria as specified in the Chapter 3.
- Due to the danger that events greater than the design flow may cause overtopping, dewatering basins require a vegetative buffer strip to filter sediment-laden overflow. A 50-foot minimum grass-covered buffer width is required for slopes less than 20 degrees (1:2.7) when the right-of-way is not limited. For slopes greater than 20 degrees, basins should have a 100-foot minimum buffer width when practical.

### **8.19.5 Construction Specifications**

Installation must meet the following guidelines:

1. Store excavated subsoil and topsoil separately and replace in their natural order.
2. Prevent the excavated sediments from entering the stream by using sediment perimeter controls or other measures.
3. The dewatering basin must have a minimum depth of 3 feet where basin depth is measured from the top of the straw bales to the bottom of the excavation.
4. Once the dewatering basin becomes filled to one-half of the excavated depth, remove the accumulated sediment and dispose in an approved area outside the 100-year floodplain.

### **8.19.6 Maintenance**

During construction, periodically maintain perimeter controls to ensure proper functioning; always check after a rain event. Inspect for erosion at outlet of basin and repair as needed. Place additional outlet protection if this issue persists.

To remove the dewatering basin:

1. Inspect site to determine practice is no longer needed.
2. Remove sediment buildup (if applicable).
3. Remove practice.
4. Revegetate area disturbed by practice removal (if applicable).

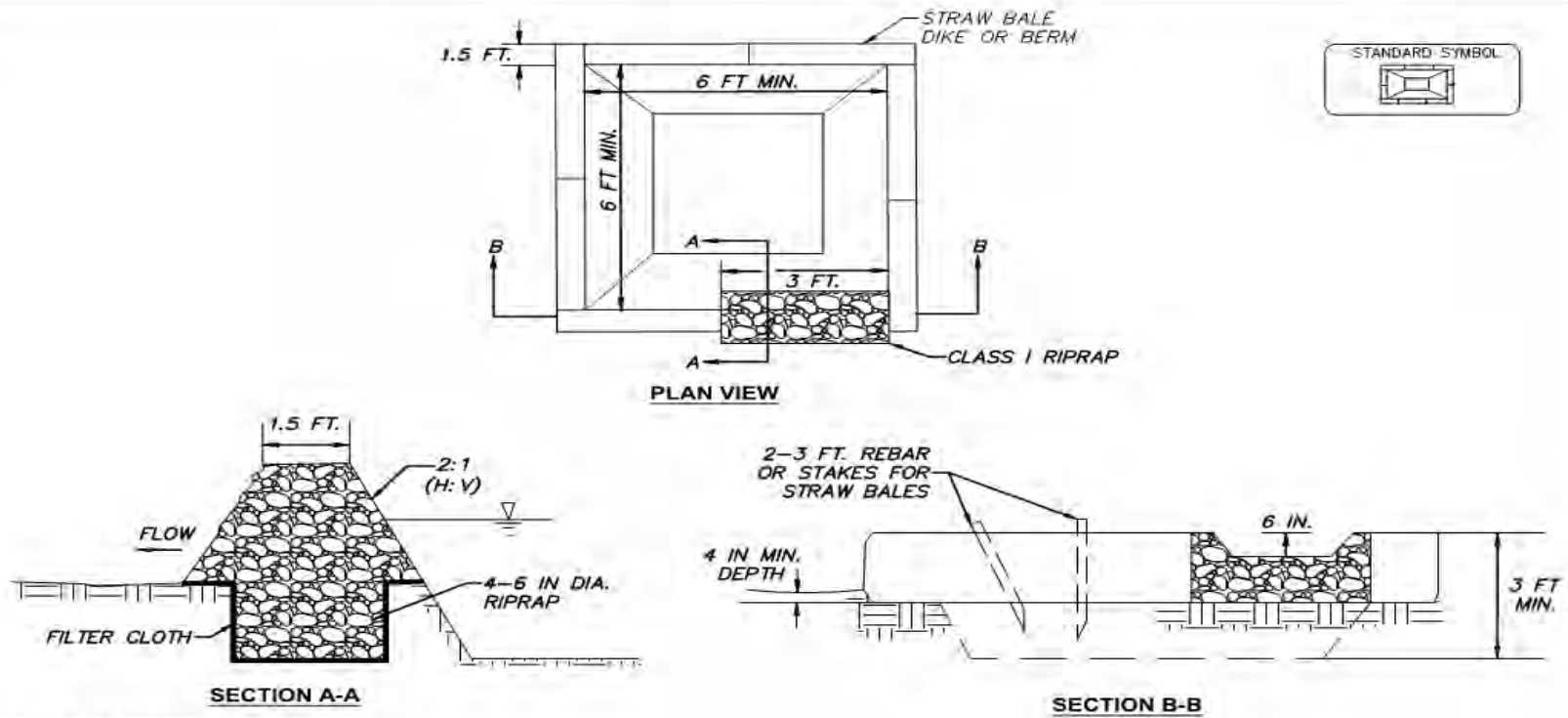

**CONSTRUCTION SPECIFICATIONS**

INSTALLATION MUST MEET THE FOLLOWING GUIDE:

1. STORE EXCAVATED SUBSOIL AND TOPSOIL SEPARATELY AND REPLACE IN THEIR NATURAL ORDER.
2. PREVENT THE EXCAVATED SEDIMENTS FROM ENTERING THE WATERWAY BY USING SEDIMENT PERIMETER CONTROLS OR OTHER MEASURES.
3. THE DEWATERING BASIN MUST HAVE A MINIMUM DEPTH OF 3 FEET WHERE BASIN DEPTH IS MEASURED FROM THE TOP OF THE STRAW BALES TO THE BOTTOM OF THE EXCAVATION.
4. ONCE THE DEWATERING BASIN BECOMES FILLED TO ONE-HALF OF THE EXCAVATED DEPTH, REMOVE THE ACCUMULATED SEDIMENT AND DISPOSE IN AN APPROVED AREA OUTSIDE THE 100-YEAR FLOODPLAIN.

DATE	APPR	
	REVISED	
ISSUED:		
	REFERENCE	

**DEWATERING BASINS**

★ ★ ★ DISTRICT OF COLUMBIA  
 DEPARTMENT OF ENERGY &  
 ENVIRONMENT

DWG. NO 819.1

SOURCE: 2011 MARYLAND STANDARDS & SPECIFICATIONS

Detail 74 – 819.1 Dewatering Basins

## Chapter 9 Other Practices

### 9.1 Dust Control

#### 9.1.1 Definition

To control blowing dust and movement on construction sites and roads.

#### 9.1.2 Purpose

To prevent or reduce the blowing and movement of dust from disturbed soil surfaces that may create off-site damage, health hazards, and traffic safety problems.

#### 9.1.3 Conditions Where Practice Applies

This practice is applicable to areas subject to dust blowing and movement where on and off-site nuisance dust damage is likely without treatment.

#### 9.1.4 Design Criteria

When designing a dust control plan for a site, the amount of soil exposed will dictate the quantity of dust generation and transport. Therefore, construction sequencing and disturbing only small areas at a time can greatly reduce problematic dust from a site. If land should be disturbed, consider additional temporary stabilization measures prior to disturbance.

#### Temporary Methods

1. Mulches – See Section 2.7 Mulching. Chemical or wood cellulose fiber binders must be used instead of asphalt to bind mulch material.
2. Vegetative Cover – See Section 2.10 Vegetative Stabilization.
3. Spray-on Adhesives – Use on mineral soils (not effective on muck soils). These are generally synthetic materials that are applied to the soil surface to act as binding agents. Asphalt-based and coal tar-based materials are not accepted. Keep traffic off these areas once they have been treated. The following table may be used for general guidance.

**Table 9.1 Spray-on Adhesives Guidance**

<b>Adhesive</b>	<b>Water Dilution (Adhesive: Water)</b>	<b>Type of Nozzle</b>	<b>Application Rate (gallons/acre)</b>
Latex emulsion	12.5:1	Fine spray	235
Resin-in-water emulsion	4:1	Fine spray	300
Acrylic emulsion (non-traffic)	7:1	Coarse spray	450
Acrylic emulsion (traffic)	3.5:1	Coarse spray	350

4. Tillage – This is an emergency temporary practice that will scarify the soil surface and prevent or reduce the amount of blowing dust until a more appropriate solution can be implemented. Begin the tillage operation on the windward side of site. Use a chisel-type plows to produce the best results.
5. Sprinkling – This is the most commonly used dust control practice. The site is sprinkled with water until the surface is moist and repeated as needed. This practice can be particularly effective for road construction and other traffic routes. The site must not be sprinkled to the point that runoff occurs.
6. Barriers – Solid board fences, snow fences, burlap fences, straw bales, crate walls, or similar materials can be used to control air currents and soil blowing.
7. Calcium Chloride – Can be applied as flakes or granular material with a mechanical spreader at a rate that will keep the soil surface moist but not so high as to cause water pollution or plant damage. Can be reapplied as necessary.

#### Permanent Methods

1. Permanent Vegetation – See Section 2.10 Vegetative Stabilization. Existing trees or large shrubs may afford valuable protection if left in place.
2. Topsoiling – Covering with less erosive soil materials. See Section 2.6 Topsoiling.
3. Stone – Cover surface with crushed stone or coarse gravel. See Section 2.3 Construction Road Stabilization and Section 2.4 Construction Debris Ground Cover.

#### **9.1.5 Construction Specifications**

1. The contractor must conduct operations and maintain the project site so as to minimize the creation and dispersion of dust. Use dust control throughout the work at the site.
2. The contractor must provide clean water, free from salt, oil, and other deleterious material to be used for on-site dust control.
3. The contractor shall supply water-spraying equipment capable of accessing all work areas.
4. The contractor shall implement strict dust control measures during active construction periods on-site. These control measures shall generally consist of water applications that

shall be applied a minimum of once per day during dry weather or more often as required to prevent dust emissions.

5. For water application to undisturbed soil surfaces, the contractor shall:
  - (a) Apply water with equipment consisting of tank, spray bar, and pump with discharge pressure gauge.
  - (b) Arrange spray bar height, nozzle spacing and spray pattern to provide complete coverage of ground with water.
  - (c) Disperse water through nozzles on spray bar at 20 psi (137.8 kPa) minimum. Keep areas damp without creating nuisance conditions such as ponding.
6. For water application to soil surfaces during demolition and/or excavation, the contractor shall:
  - a) Apply water with equipment consisting of a tank, pump with discharge gauge, hoses and mist nozzles.
  - b) Locate tank and spraying equipment so that the entire excavation area can be misted without interfering with demolition and/or excavation equipment or operations. Keep areas damp without creating nuisance conditions such as ponding.
  - c) Apply water spray in a manner to prevent movement of spray beyond the site boundaries.

#### **9.1.6 Maintenance**

Because dust controls are dependent on specific site and weather conditions, inspection and maintenance are unique for each site. Generally, dust control measures involving application of either water or chemicals require more monitoring than structural or vegetative controls to remain effective. If structural controls are used, inspect them for deterioration on a regular basis to ensure that they are still achieving their intended purpose.

## **9.2 On-site Concrete Washout Structure**

### **9.2.1 Definition**

A prefabricated or fabricated container used for containing wash water from rinsing out concrete trucks, drums, pumps, chutes, other equipment, and concrete truck exteriors after delivery on-site.

### **9.2.2 Purpose**

To promote proper disposal of waste concrete and wash water by containing it on-site, thereby preventing contamination of waterways, groundwater, and storm drains.

### **9.2.3 Conditions Where Practice Applies**

Concrete washout structures are used when concrete equipment is cleaned on-site.

### **9.2.4 Design Criteria**

#### Location

Concrete washout structures must be located a minimum of 50 feet away from open channels, storm drain inlets, sensitive areas, wetlands, buffers, and waterways. The location of the washout structure must be away from construction traffic, yet convenient for the concrete trucks to access and utilize the station. Excavated washout structures must be located so that they do not intercept surface runoff. If runoff drains toward an excavated structure, a diversion must be provided around the structure. The washout structure must have a paved or gravel access drive leading to it with a minimum width of 10 feet and sloped downwards towards the washout at a 2% slope. The access drive must connect to a paved or gravel surface. Prefabricated containers are an acceptable alternative to fabricated washout structures provided the volume is adequate to contain all wash water and solids while maintaining at least 4 inches of freeboard. Place signs designating the BMP throughout the construction site to direct traffic to its location.

#### Type

For an excavated concrete washout, size the BMP to be at least 6 feet by 6 feet at the bottom and 3 feet deep. Excavate the area to the required depth with 2:1 side slopes. The concrete washout can also be constructed at-grade using straw bales or a filter sock. The BMP may be larger and sized per the expected loadings (i.e., if a pump truck is needed to install the concrete, then account for the increase in washout volume with a larger BMP). Prepare the soil base to be free of rocks or other debris that may cause tears or holes in the liner. Line the washout area with minimum 10 mil thick, UV resistant, polyethylene fabric free of holes, tears, or other defects that would compromise the impermeability of the material. For an excavated washout area, anchor the liner in place by backfilling underneath a 1 foot high, 1 foot wide berm, located around the perimeter except for the access road. If it is anticipated to empty out and reuse the washout, the liner may be draped over the berm and anchored on the downslope side with sandbags. For an at-grade concrete washout, anchor the liner with staples at the stake location. In high groundwater situations and permeable soils, the liner will prevent the concrete wastewater from leaching prior to it solidifying.



Prefabricated concrete washouts can also be used and are useful for sites that cannot excavate below ground, or need the versatility of being able to move the station to different locations. Place a manufactured unit with minimum 4-foot by 4-foot area and 12 inches depth on top of a wooden pallet. Line the unit with a minimum 4 mil polyethylene liner (must meet manufacturer's recommendations) that can be tied off during rain events. After the washout unit is utilized it should remain exposed (except during rain events) so that the wastewater can evaporate, leaving only solid concrete residue. The pallet can then be picked up with a forklift and disposed of in a dump truck. A typical 4-foot by 4-foot unit can accommodate 10 washouts before needing to be replaced. Adjust the unit size or disposal frequency depending on the expected frequency of use.

### **9.2.5 Construction Specifications**

1. Locate the washout structure a minimum of 50 feet away from open channels, storm drain inlets, sensitive areas, wetlands, buffers, and water courses and away from construction traffic.
2. Size the washout structure for the volume necessary to contain wash water and solids and maintain at least 4 inches of freeboard.
3. Prepare the soil base to be free of rocks or other debris that may cause tears or holes in the liner. For the liner use UV resistant, impermeable sheeting, free of holes and tears or other defects that compromise impermeability of the material.
4. Provide a sign for the washout near the BMP.
5. Apply a new liner before reusing the station for additional washouts after maintenance has occurred.

### **9.2.6 Maintenance**

It is critical that the concrete washout structure be watertight. The impermeable liner must be replaced if damaged (e.g., ripped or punctured). A washout structure that is 75% full must be emptied or replaced, and the hardened concrete must be disposed of properly. The liner may not be reused. Prefabricated containers require less maintenance. Stored liquids that have not evaporated can be wet vacuumed and disposed of in an approved manner. Prior to forecasted rainstorms, remove liquids or cover the structure to prevent overflows. Hardened solids can be removed whole or broken up for disposal or recycling. Maintain runoff diversion around excavated washout structure until structure is removed.

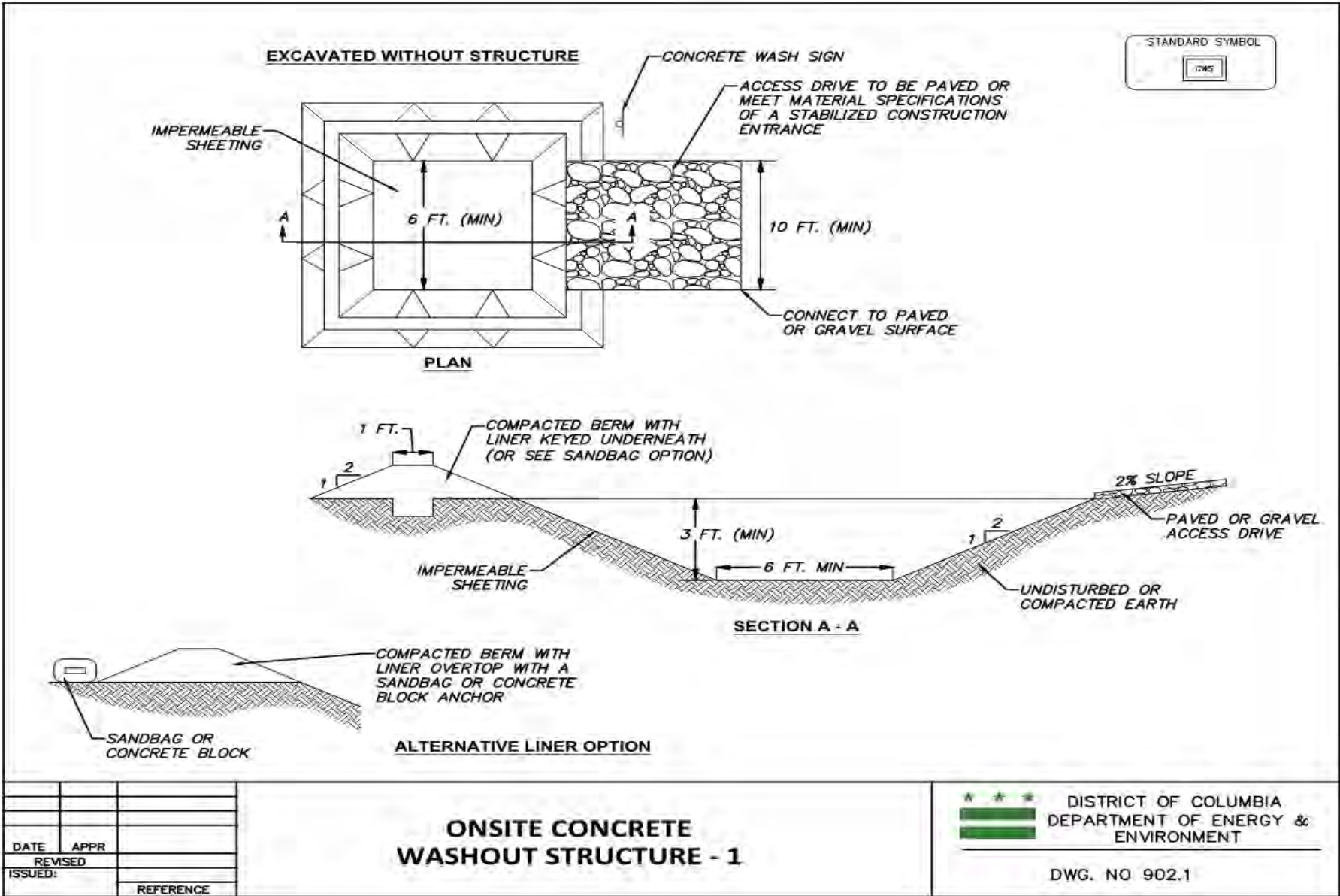

Detail 75 – 902.1 Onsite Concrete Washout Structure - 1

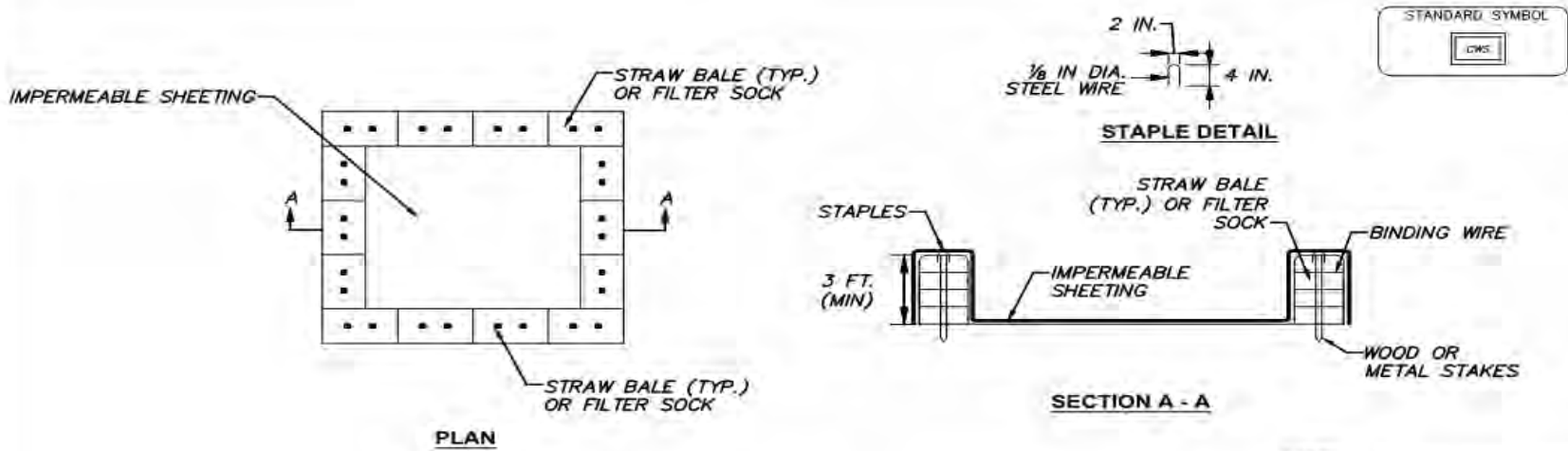

**WASHOUT STRUCTURE WITH STRAW BALES OR FILTER SOCK**

**NOTE:**  
 • CAN BE STACKED BALES OR FILTER SOCKS OR PARTIALLY EXCAVATED TO REACH 3 FOOT DEPTH.

**CONSTRUCTION SPECIFICATIONS**

1. LOCATE WASHOUT STRUCTURE A MINIMUM OF 50 FEET AWAY FROM OPEN CHANNELS, STORM DRAIN INLETS, SENSITIVE AREAS, WETLANDS, BUFFERS AND WATER COURSES AND AWAY FROM CONSTRUCTION TRAFFIC.
2. SIZE WASHOUT STRUCTURE FOR VOLUME NECESSARY TO CONTAIN WASH WATER AND SOLIDS AND MAINTAIN AT LEAST 4 INCHES OF FREEBOARD.
3. PREPARE SOIL BASE FREE OF ROCKS OR OTHER DEBRIS THAT MAY CAUSE TEARS OR HOLES IN THE LINER. FOR LINER, USE UV RESISTANT, IMPERMEABLE SHEETING, FREE OF HOLES AND TEARS OR OTHER DEFECTS THAT COMPROMISE IMPERMEABILITY OF THE MATERIAL.
4. PROVIDE A SIGN FOR THE WASHOUT IN CLOSE PROXIMITY TO THE FACILITY.
5. APPLY A NEW LINER BEFORE REUSING THE STATION FOR ADDITIONAL WASHOUTS AFTER MAINTENANCE HAS OCCURRED.

DATE	APPR	
REVISED		
ISSUED:		
	REFERENCE	

**ONSITE CONCRETE WASHOUT STRUCTURE - 2**

 DISTRICT OF COLUMBIA  
 DEPARTMENT OF ENERGY &  
 ENVIRONMENT

DWG. NO 902.2

SOURCE: 2011 MARYLAND STANDARDS AND SPECIFICATIONS

Detail 76 – 902.2 Onsite Concrete Washout Structure - 2

## **9.3 Tree Protection and Preservation**

### **9.3.1 Definition**

Protection and preservation of desirable trees from mechanical and other injury while the land is being developed.

### **9.3.2 Purpose**

To provide the necessary protective measures to ensure the survival of desirable trees for shade, beautification, and vegetative cover, as well as denote areas to be avoided with construction equipment.

### **9.3.3 Conditions Where Practice Applies**

DOEE regulated areas outside of the public right-of-way (PROW) that are occupied by single specimen trees or groups of trees. Follow DDOT UFA specifications for trees in the PROW.

### **9.3.4 Design Criteria**

No formal design is required. The areas to be protected must be indicated on the construction plans with protection fencing, and the construction around these areas must be minimized.

#### Selecting Trees to Preserve and Protect

Consult an arborist for recommendations on which trees to preserve. In general, note the following considerations:

1. Life expectancy – Give preference to trees with a long life span. If the cost of preservation is greater than the cost of replacement with a specimen of the same age and size, replacement may be preferred.
2. Health and disease susceptibility – Check for insect or disease damage. Also, look for rotted or broken trunks/limbs. Pest and pollution-resistant trees are preferred.
3. Structure – Check for these structural defects that may indicate weakness or reduce the aesthetic value of a tree: trees growing from old stumps, misshapen trunks or crowns, and small crowns at the top of tall trunks.
4. Aesthetic values – Trees that provide interest during several seasons of the year enhance the value of the site.
5. Energy efficiency – Trees help relieve the heat of summer and buffer strong winds throughout the year. Summer temperatures may be 10 degrees cooler under hardwoods than under conifers. Deciduous trees drop their leaves in winter, allowing the sun to warm buildings and soil. Evergreens are more effective wind buffers.
6. Wildlife – Give preference to trees that provide food, cover, and nesting sites for birds and wildlife.
7. Adaptability to the proposed development – Consider the mature height and spread of trees; they may interfere with proposed structures and overhead utilities. Roots may interfere with

walls, walks, driveways, patios, and other paved surfaces; or water lines and underground drainage.

Trees must be appropriate to the proposed use of the development. Select tree species that are pollution-tolerant for high-traffic and industrial areas and salt tolerant species for areas exposed to deicing salts or ocean spray. Select buffer tree species for noise or screening species for objectionable views.

Determine the effect of proposed grading on the water table. Do not grade within the drip line of any tree to be saved.

8. Survival needs of the tree – Chosen trees must have enough room to develop naturally. Trees remaining after site clearing will be subject to injury from increased exposure to sunlight, heat radiated from buildings and pavement, and wind. It is best to retain groups of trees rather than individuals. As trees mature, they can be thinned gradually.

#### Site Planning for Tree Preservation and Protection

1. If lot size allows, select trees to be saved before siting buildings or other structures. Do not destroy or alter any tree until the design of buildings and utility systems is final.
2. Leave steep slopes in their natural condition.
3. Clearly note the size and location of tree protection zones (see Figure 9.2) in site design drawings (including the demolition, utility, grading, and site layout sheets) and erosion plans. Include in the site survey all trees outside of the area of disturbance that have their critical root zone within the area of disturbance.
4. Note construction material storage areas and worker parking on the site plan, and locate away from tree preservation areas.
5. Keep excavations for basements and utilities away from the drip line of trees. Minimize trenching by locating several utilities in the same trench.
6. When retaining existing trees in parking areas, leave enough ground ungraded beyond the drip line of the tree to allow for its survival.
7. Locate erosion and sediment control measures at the limits of clearing and not in wooded areas, to prevent deposition of sediment within the drip line of trees being preserved. Construct sediment basins in the natural terrain, if possible, rather than in locations where extensive grading and tree removal will be required.

#### Design Specifications

The Critical Root Zone (CRZ) is equal to 1.5 feet of tree protection (radius of circle) for every 1-inch in tree diameter (see Figure 9.1). The following are not permitted in the CRZ:

1. Alteration or disturbance to the existing grade.
2. Storage of construction materials, equipment, soil, or debris.
3. Disposal of any liquids (e.g., concrete, gas, oil, paint, chemicals, etc.).
4. Installation of silt fence/super silt fence or trenching.

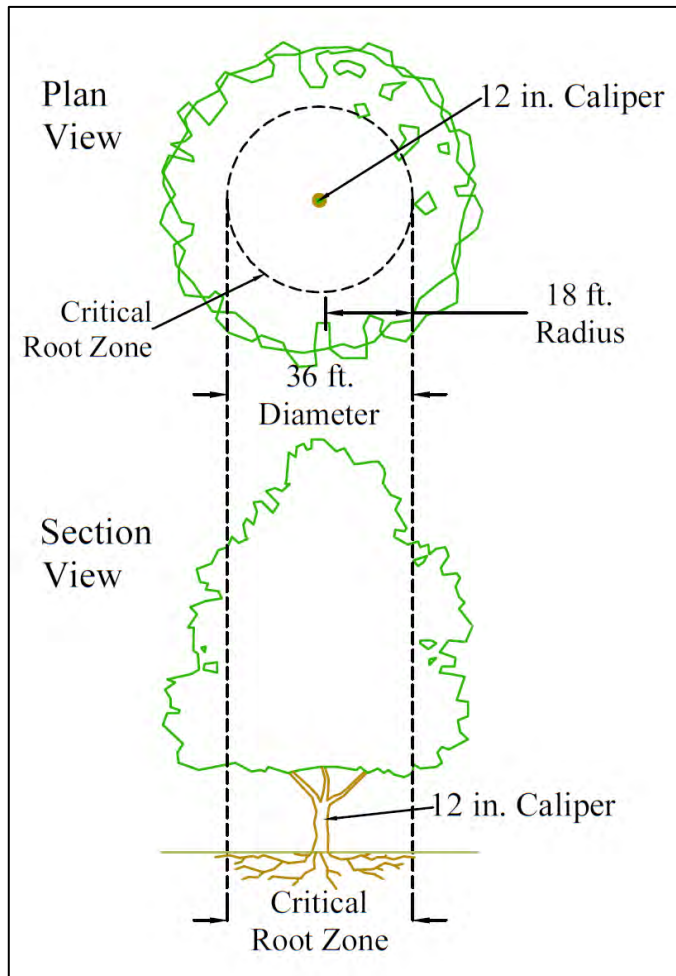
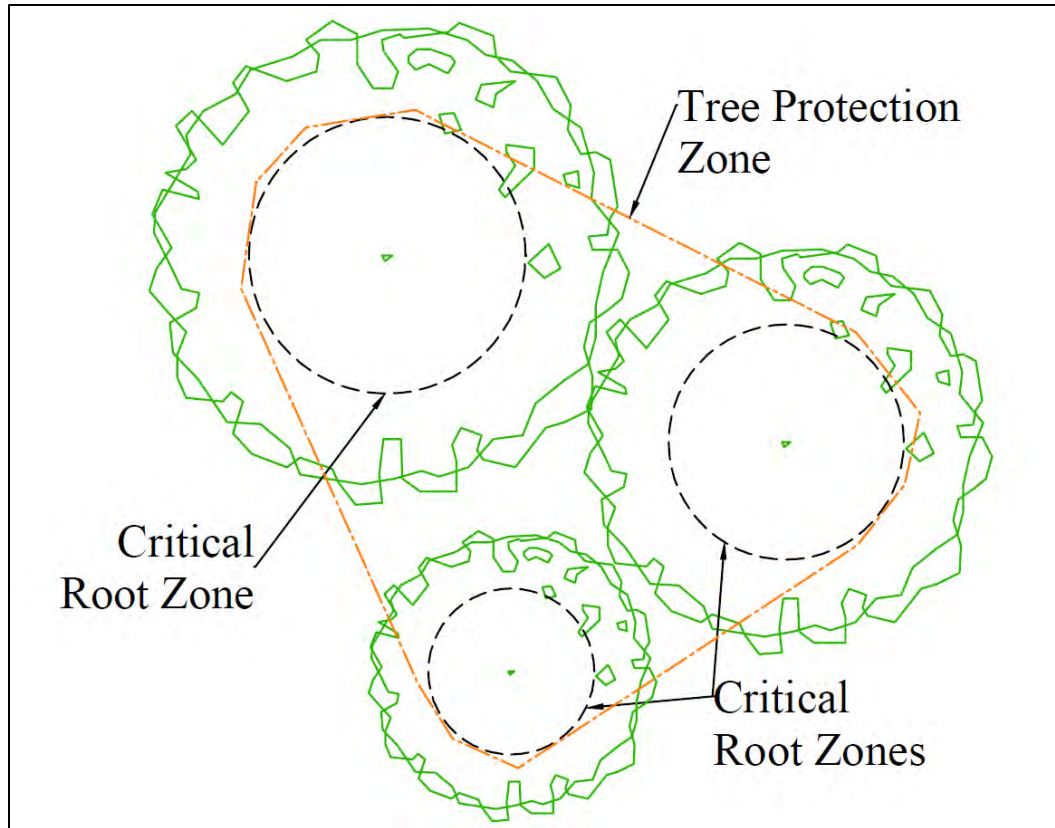

**Figure 9.1 Critical root zone.**

The tree protection zone consists of fencing and root zone protection measures that enclose the entire CRZ (see Figure 9.2). For single trees, the tree protection zone and the CRZ may be the same. Tree protection measures must meet the following specifications:

1. The fencing must be 6-foot tall chain link or 4-foot high wooden snow fencing constructed on all sides of the tree protection zone. Install fencing prior to and maintain through construction, removing only at the end of the project.
2. Fencing must protect an area no smaller than the CRZ, centered on the tree.
3. Fencing must have vertical and horizontal support railings to decrease flexibility and prevent sagging.
4. Anchor fence posts in the ground to prevent movement and provide a secure barrier.





**Figure 9.2** Tree protection zone.

### 9.3.5 Construction Specifications

1. Groups of trees and individual trees selected for retention must be accurately located on the plan and designated as “tree(s) to be saved.” Individual specimens that are not part of a tree group must also have their species and diameter noted on the plan.
2. Prior to construction and before the preconstruction meeting, mark individual trees and stands of trees to be retained within the limits of clearing at a height visible to equipment operators.
3. During any preconstruction meeting, review tree preservation and protection measures with the contractor as they apply to that specific project.
4. Define the critical root zone.
5. Construct the tree protection zone.
6. Tree branches that interfere with the construction may be tied back or pruned only to the point necessary to complete the work. Tying back or trimming of all branches must be in accordance with accepted arboricultural practices (ANSI A300, part 8) and be performed under supervision of an arborist.
7. Mechanical boring is required to tunnel under the CRZ. The boring must be at a minimum depth of 30 inches. Excavations must proceed with care by use of hand tools.

8. Do not cut roots larger than 2 inches in diameter without DOEE's permission.
9. Wrap exposed roots 2 inches and larger in diameter in burlap or other approved material and keep moist at all times.
10. Heavy equipment, vehicular traffic, or stockpiles of any construction materials (including topsoil) are not permitted within the CRZ of any tree to be retained unless the specifications shown in Detail 903.2 are followed per arborist's direction. Silt fencing must not be trenched.
11. Trees to be removed must be removed in a controlled manner and not felled, pushed, or pulled into trees being retained. Do not damage tree trunks and limbs by construction equipment. Do not nail boards to trees during building operations.

### **9.3.6 Maintenance**

Place tree protection fencing and root protection measures before any excavation or grading is begun, keep in good repair for the duration of construction activities, and remove last during the final cleanup after the completion of the project.

Repair any damage to the crown, trunk, or root system of the tree immediately as prescribed by a forester or ISA certified arborist. Broad leaf trees may need an application of complete fertilizer to aid their recovery from possible damage caused by construction operations. Fertilize during winter and/or early spring following completion of construction. Follow the arborist's recommendations as to fertilizer type, amount, and frequency of application.

Water trees that are protected every 10 days from April through September.



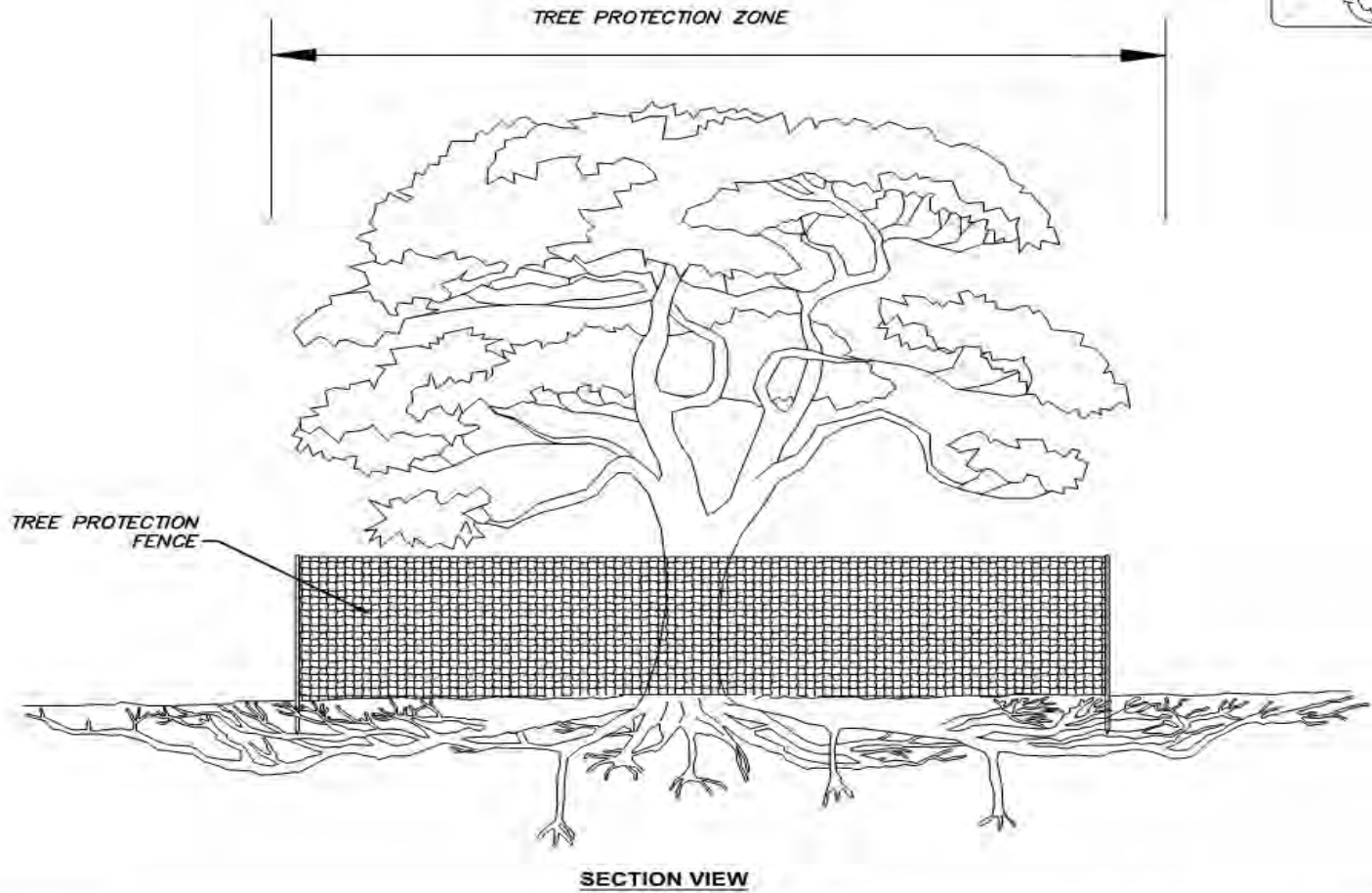

DATE	APPR	
REVISED		
ISSUED:		
	REFERENCE	

**TREE PROTECTION**

★ ★ ★ DISTRICT OF COLUMBIA  
 DEPARTMENT OF ENERGY &  
 ENVIRONMENT

DWG. NO 903.1

SOURCE: URBAN TREE FOUNDATION 2014

Detail 77 – 903.1 Tree Protection



## **9.4 Flocculants**

### **9.4.1 Definition**

The process by which small particles of fine soils and sediments are induced to aggregate into larger lumps, or “flocs,” through the application of a chemical agent. These flocs more readily settle out compared to the individual particles.

### **9.4.2 Purpose**

To protect streams from the impact of turbid stormwater discharges, especially when construction continues in wet weather conditions. Traditional soil erosion and sediment control practices may not be adequate to control fine particles suspended in runoff, such as clay and fine silt. Suspended sediment reduces the biological productivity of the affected waters, decreases recreational value, and increases water treatment costs for industrial or drinking water plants. The purpose of flocculants is to treat the water so that suspended clays and fine silts will settle out of the water quickly before leaving the construction site.

### **9.4.3 Conditions Where Practice Applies**

Only employ flocculation when traditional “first line of defense” practices, such as vegetative stabilization, sediment traps, etc. are ineffective and/or additional treatment of stormwater runoff from a disturbed area is warranted. Flocculation may also be required to meet conditions of the DC Water’s Temporary Discharge Authorization Permit.

### **9.4.4 Design Criteria**

Turbidity is difficult to control once fine particles are suspended in stormwater runoff from construction sites. Flocculation of runoff after settling larger particulate matter in a sediment pond or other practice is an effective turbidity control if the treatment system is properly designed and implemented. The use of flocculants is very soil-type dependent and requires a screening process to determine the best chemical for each specific location. Care must be taken to ensure that chemically treated stormwater discharged from construction sites is nontoxic to aquatic organisms and does not violate applicable District or federal regulations.

Extensive monitoring may be necessary to ensure not only that turbidity reduction goals are being met, but that toxicity of the treated discharge is not an issue. The space necessary for pumps, treatment cells, and chemical feed systems can be a problem on smaller sites.

### **9.4.5 Construction Specifications**

The design and operation of a flocculation system should take into consideration the factors that determine optimum, cost-effective performance, while ensuring non-toxic discharges.

#### **1. Product Evaluation**

- (a) Treatment chemicals must be approved by EPA for potable water use.
- (b) Petroleum-based polymers are prohibited.

- (c) DOEE must approve the use of any flocculant prior to its use on a construction site.
- (d) The approval of a treatment chemical is conditional, subject to monitoring of treated stormwater at the subject construction site.
- (e) Authorization to use a chemical in the field does not relieve the applicant from responsibility for meeting all discharge and receiving water criteria applicable to a site.

## 2. Planning Considerations

- (a) Design flocculation systems as a part of the overall Stormwater Management Plan whenever problem soils are anticipated.
- (b) Several different flocculant materials are available, and the specific configuration depends on the soil texture, as well as other site conditions. Plans must identify soil or water sample needs necessary to select the appropriate dosage and application method.
- (c) Flocculants are most effective when applied to the soil surface in anticipation of a runoff event. They may also be installed in the form of “floc blocks” in conveyance systems upstream from a sediment trapping practice, such as a storm drain junction box where a pipe is dropping water, inside a slope drain, or other areas of falling or fast moving water upslope from a sediment trap or basin. If applied directly to a pool of sediment-laden runoff, the coagulant must be mixed rapidly into the water to insure proper dispersion.
- (d) A flocculation step is important to increase the rate of settling, produce the lowest turbidity, and keep the dosage rate as low as possible.
- (e) Consult manufacturers’ guidance for specific standards regarding the flocculation phase. Too little energy input into the water during the flocculation phase results in flocs that are too small and/or insufficiently dense. Too much energy can rapidly destroy floc as it is formed.
- (f) Since the volume of the basin is a determinant in the amount of energy per unit volume, the size of the energy input system could be too small relative to the size of the basin.
- (g) Care must be taken in the design of the withdrawal system to minimize outflow velocities and to prevent floc discharge. Direct the discharge through a physical filter such as a vegetated swale that would catch any unintended floc discharge.

## 3. Flocculation Materials

- (a) A variety of flocculant materials are available. Since trace amounts of flocculant will undoubtedly be discharged, use a product that is non-toxic and safe for both human and aquatic life and does not create biochemical oxygen demand (BOD) problems in the downstream discharge waters.
- (b) One flocculant that has been commonly used for stormwater applications is polyacrylamide (PAM). Two versions of PAM are available, cationic and anionic. Only use anionic PAM, as cationic PAM is considered highly toxic. Anionic PAM has been used for many years in the water and wastewater industry and is considered safe for humans and aquatic life when used at the recommended rates. See Section 2.11 Polyacrylamides.

- (c) Chitosan is another flocculant that is derived from the exoskeletons of crustaceans. It is generally considered safe for use in stormwater and waterbodies.
- (d) Selection of an appropriate flocculant is highly dependent on the soil particle type and concentration. Analysis of a sample of the contaminated water is usually required to select the proper product and application rate. Manufacturers of these products will normally assist in this process.

#### 4. Flocculation System Design

- (a) Design flocculation procedures in accordance with the manufacturer's recommendations. Ponds or portable tanks are typically used for treatment. Flow-through systems with no means to trap or filter the flocculant are not permitted.
- (b) A typical flocculation system may contain various components, including but not limited to a stormwater conveyance system, a storage pond, filter, pumps, a chemical feed system, treatment cells, and interconnecting piping.
- (c) It is recommended that storage ponds or other holding areas have a capacity of 1.5 times the volume to be treated. Provide a bypass around the system to accommodate extreme storm events.
- (d) Encourage primary settling in the storage pond. A forebay is helpful.
- (e) Treatment cell sizing must consider the discharge flow rate and the desired drawdown time.
- (f) Discharge rates off site must meet all applicable requirements.
- (g) Do not apply flocculants directly to surface waters of the District.

#### 5. Monitoring

- (a) Operational monitoring should include pH, conductivity (as a surrogate for alkalinity), turbidity, and temperature of untreated stormwater. Other important quantities include total volume treated, amount of polymer used for treatment, and settling time.
- (b) Discharge monitoring should include pH, turbidity and toxicity of treated stormwater, as well as discharge rates.
- (c) Conduct any other monitoring necessary to meet federal and District water quality standards.
- (d) Submit monitoring reports to DOEE periodically, as identified in the monitoring plan.

#### 6. Education

- (a) Extensively train each contractor who intends to use chemical treatment by experienced personnel.
- (b) If a different contractor is used for chemical stormwater treatment than the general construction site contractor, hold regular coordination meetings between all responsible parties.

#### **9.4.6 Maintenance**

Clean out pretreatment and treatment ponds and cells periodically, and properly dispose of sediment or floc. Pumps and feed systems must be maintained in good working order. Inspect and maintain conveyance systems in order to function as designed. Check discharge points to ensure that no erosion is occurring from the release of treated runoff.

## 9.5 New Products and Procedures

The BMPs set forth in this manual must be appropriately incorporated into all erosion and sedimentation control plans unless the designer shows that alteration of these BMPs or inclusion of other BMPs effectively minimizes accelerated erosion and sedimentation as well as, or better than, the BMPs in this manual. Since the burden of proof concerning the effectiveness of a proposed new product or procedure lies with the designer, all necessary information required to approve the use of the new product or procedure must be submitted as part of the application. At a minimum, include the following:

1. The name of the product (and type of control if a brand name is used).
2. The proposed use (e.g., storm sewer inlet protection) for the product. If this product or procedure has the potential to minimize accelerated erosion and sedimentation more effectively or efficiently than current methods, this should be stated and the reason given (e.g., same protection for less cost, less maintenance required, etc.). Demonstrate that the proposed use meets with any manufacturer's recommendations (e.g., copy of manufacturer's brochure showing such use, test data, limitations, etc.).
3. Where the proposed use is in a protected watershed or within a buffer (e.g., adjacent to a stream channel or wetland), specify an alternative conventional BMP for immediate installation should the innovative product or procedure fail. The definition of a product failure must be clearly stated.
4. Provide sufficient installation information to ensure its proper use. Include a clear, concise sequence as well as a typical detail showing all critical dimensions and/or elevations. Provide proof that the alternate BMP was previously installed and worked under conditions comparable to the environmental conditions of the proposed site.
5. Show on the plan maps all locations where the proposed new product or procedure will be used. Identify all receiving waters. Note any downstream public water supplies, fish hatcheries, or other environmentally sensitive facilities.
6. Provide a suitable maintenance program. Include specific instructions, which identify potential problems and recommended remedies.

New products and procedures which meet the above criteria will be reviewed on a case-by-case basis until their effectiveness has been sufficiently demonstrated by successful use in the field.





---

## Chapter 10 References

- Anne Arundel Soil Conservation District. Land Application of Polyacrylamide General Guidance. <http://www.aascd.org/test-forms/PolyacrylamideGuidance.pdf?attredirects=0>
- Arcement, Jr., G.J. and V.R. Schneider. 1989. Guide for Selecting Manning's Roughness Coefficients for Natural Channels and Flood Plains. United States Geological Survey, Water-Supply Paper 2339. <http://pubs.usgs.gov/wsp/2339/report.pdf>
- Bennett, Sean J., A. Simon, J.M. Castro, J.F. Atkinson, C.E. Bronner, S.S. Blersch, A.J. Rabideau. 2011. Stream Restoration in Dynamic Fluvial Systems: Scientific Approaches, Analyses, and Tools. "The Evolving Science of Stream Restoration." Geophysical Monograph Series 194. American Geophysical Union. 10.1029/2011GM001099.
- Bernhardt, E.S., Palmer, M.A., Allan, J.D., Alexander, G., Barnas, K., Brooks, S. 2005. Synthesizing U.S. River Restoration Efforts. Science. AAAS, Washington, DC. Volume 308, Number 5722. Pages 636-637.
- Center for Watershed Protection (CWP). 2000. "Muddy Water In, Muddy Water Out?" The Practice of Watershed Protection. T. Schueler and H. Holland. Ellicott City, MD. pp. 305-315.
- Clinton, D. R., G.D. Jennings, R.A. McLaughlin and D.A. Bidelspach, 2004. Sediment and Erosion Control Techniques on Stream Restoration Projects.
- Comey, J., C. Narducci, and P.A. Tatian. 2010. State of Washington, D.C.'s Neighborhoods 2010. Prepared by the Urban Institute for the Office of Planning, Government of the District of Columbia, accessed at <http://www.urban.org/research/publication/state-washington-dcs-neighborhoods>
- Copeland, R.R., D.N. McComas, C.R. Thorne, P.J. Soar, M.M. Jonas, and J.B. Fripp, 2001. Hydraulic Design of Stream Restoration Projects. ERDC/CHL TR-01-28, U.S. Army Engineer Research and Development Center, Coastal and Hydraulics laboratory, Vicksburg, MS.
- Cramer, Michelle L. (managing editor). 2012. Stream Habitat Restoration Guidelines. Co-published by the Washington Departments of Fish and Wildlife, Natural Resources, Transportation and Ecology, Washington State Recreation and Conservation Office, Puget Sound Partnership, and the U.S. Fish and Wildlife Services. Olympia, Washington. <http://wdfw.wa.gov/publications/01374/wdfw01374.pdf>
- Delaware Department of Natural Resources and Environmental Control (DNREC). 2013. Delaware Erosion and Sediment Control Handbook. <http://www.dnrec.delaware.gov/swc/Drainage/Documents/Sediment%20and%20Stormwater>

[%20Program/Technical%20Document/Tech%20Doc%20March%202013/3.06.1%20Delaware%20ESC%20Handbook%20Rev.%202013-03.pdf](#)

District of Columbia Department of Health. 2003. 2003 District of Columbia Standards and Specifications for Soil Erosion and Sediment Control. <https://doee.dc.gov/esc>

District Department of Transportation (DDOT). 2015. Standard Drawings. <http://ddot.dc.gov/page/standard-drawings-2015>

District Department of Transportation – Urban Forestry Administration (DDOT-UFA). Construction Guidelines for Tree Protection. [http://ddot.dc.gov/sites/default/files/dc/sites/ddot/publication/attachments/guidelines\\_tree\\_protection\\_during\\_construction.pdf](http://ddot.dc.gov/sites/default/files/dc/sites/ddot/publication/attachments/guidelines_tree_protection_during_construction.pdf)

Doll, B.A., G.L. Grabow, K.R. Hall, J. Halley, W.A. Harman, G.D. Jennings and D.E. Wise, 2003. Stream Restoration: A Natural Channel Design Handbook. NC Stream Restoration Institute, NC State University. 128 pp.

Federal Highway Administration (FHWA). 2005. Design of Roadside Channels with Flexible Linings. Hydraulic Engineering Circular No. 15, Third Edition. <http://www.fhwa.dot.gov/engineering/hydraulics/pubs/05114/05114.pdf>

FISRWG (10/1998). Stream Corridor Restoration: Principles, Processes, and Practices. By the Federal Interagency Stream Restoration Working Group (FISRWG) (15 Federal agencies of the US gov't). GPO Item No. 0120-A; SuDocs No. A 57.6/2:EN 3/PT.653. ISBN-0-934213-59-3.

Georgia Soil and Water Conservation Commission (GSWCC). 2000. Guidelines for Streambank Restoration. Revised March. 59 pp.

Georgia Soil and Water Conservation Commission (GSWCC). 2014. Manual for Erosion and Sediment Control in Georgia. Sixth Edition.

Harman, W., R. Starr, M. Carter, K. Tweedy, M. Clemmons, K. Suggs, C. Miller. 2012. A Function-Based Framework for Stream Assessment and Restoration Projects. US Environmental Protection Agency, Office of Wetlands, Oceans, and Watersheds, Washington, DC EPA 843-K-12-006.

Illinois Environmental Protection Agency. Construction and Demolition Debris. <http://www.epa.illinois.gov/topics/small-business/publications/construction-debris/index>

Iowa Natural Resources Conservation Services (NRCS). 2011. Mulching, Iowa Job Sheet. Iowa Conservation Practice 484. [http://www.nrcs.usda.gov/Internet/FSE\\_DOCUMENTS/nrcs142p2\\_006305.pdf](http://www.nrcs.usda.gov/Internet/FSE_DOCUMENTS/nrcs142p2_006305.pdf)

- Jarrett, A. R. 2008. Controlling the Dewatering of Sedimentation Basins. F-253. Penn State Agricultural and Biological Engineering. [http://extension.psu.edu/natural-resources/water/watershed-education/stormwater/controlling-the-dewatering-of-sedimentation-basins/extension\\_publication\\_file](http://extension.psu.edu/natural-resources/water/watershed-education/stormwater/controlling-the-dewatering-of-sedimentation-basins/extension_publication_file)
- Jenkinson, R. G., Barnas, K. A., Braatne, J. H., Bernhardt, E. S., Palmer, M. A., Allan, J. D. and The National River Restoration Science Synthesis (2006), Stream Restoration Databases and Case Studies: A Guide to Information Resources and Their Utility in Advancing the Science and Practice of Restoration. *Restoration Ecology*, 14: 177–186. doi: 10.1111/j.1526-100X.2006.00119.x.
- Johnstone, M., J. Sanders, S. VanDelfzijl, and D. Mikula. 2010. Certified Storm Water Operator and Soil Erosion and Sedimentation Control Inspector/Comprehensive Training Manual. Michigan Department of Natural Resources and Environment (MDNRE). [http://www.michigan.gov/deq/0,4561,7-135-3311\\_4113-81197--,00.html](http://www.michigan.gov/deq/0,4561,7-135-3311_4113-81197--,00.html)
- Maryland Department of the Environment (MDE). 2000. Maryland's Waterway Construction Guidelines. <http://www.mde.state.md.us/programs/Water/WetlandsandWaterways/DocumentsandInformation/Documents/www.mde.state.md.us/assets/document/WetlandsWaterways/mgwc.pdf>
- Maryland Department of the Environment (MDE). 2011. 2011 Maryland Standards and Specifications for Soil Erosion and Sediment Control. <http://www.mde.state.md.us/programs/water/StormwaterManagementProgram/Documents/2011%20MD%20Standard%20and%20Specifications%20for%20Soil%20Erosion%20and%20Sediment%20Control.pdf>
- Maryland Department of the Environment (MDE) and District of Columbia Department of the Environment (DDOE) - Natural Resources Administration. 2007. Total Maximum Daily Loads of Sediment/Total Suspended Solids for the Anacostia River Basin, Montgomery and Prince George's Counties, Maryland and The District of Columbia.
- Miller, D., P., Skidmore, and D., White, 2001. White Paper: Channel Design. Submitted to Washington Department of Fish and Wildlife, Washington Department of Ecology, and Washing Department of Transportation. Olympia, Washington.
- Natural Resources Conservation Service (NRCS). 2007. Part 654 National Engineering Handbook. Stream Restoration Design. <https://www.nrcs.usda.gov/wps/portal/nrcs/detail/national/water/manage/restoration/?cid=stelprdb1044707>
- Natural Resources Conservation Service (NRCS). Module 112 - Open Channel Hydraulics. <http://www.nrcs.usda.gov/wps/portal/nrcs/detail/national/nedc/?cid=stelprdb1047191>
- Natural Resources Conservation Service (NRCS). 2010. Lined Waterway or Outlet. [http://www.nrcs.usda.gov/Internet/FSE\\_DOCUMENTS/nrcs143\\_026310.pdf](http://www.nrcs.usda.gov/Internet/FSE_DOCUMENTS/nrcs143_026310.pdf)

- Natural Resources Conservation Service (NRCS). Design Guide MD #6: Riprap Design Methods. [http://www.nrcs.usda.gov/Internet/FSE\\_DOCUMENTS/nrcs144p2\\_025594.pdf](http://www.nrcs.usda.gov/Internet/FSE_DOCUMENTS/nrcs144p2_025594.pdf)
- North Carolina Department of Environmental Quality. Revised 2013. Erosion and Sediment Control Planning and Design Manual. <http://deq.nc.gov/about/divisions/energy-mineral-land-resources/energy-mineral-land-permit-guidance/erosion-sediment-control-planning-design-manual>
- North Dakota Department of Health – Division of Waste Management. 2009. Guideline 38 – Beneficial Use of Inert Waste. <https://www.ndhealth.gov/wm/Publications/Guideline38BeneficialUseOfInertWaste.pdf>
- Nowak, D. and E. Greenfeld. 2012. “Tree and Impervious Cover Change in U.S. Cities.” *Urban Forestry and Urban Greening*, 11(1): 21-30.
- Ossi, D., D. Rauch, L. Rohr, S. Spencer, and J. L. Murrow. 2015. District of Columbia Wildlife Action Plan. Department of Energy and Environment (DOEE), Government of the District of Columbia.
- Palmer, M., Hondula, K., Koch, B. 2014. Ecological Restoration of Streams and Rivers: Shifting Strategies and Shifting Goals: Annual Review of Ecology, Evolution, and Systematics. University of Maryland, College Park, MD. Volume 45, Pages 247-269.
- Pennsylvania Department of Environmental Protection. 2012. Erosion and Sediment Pollution Control Program Manual. <http://www.elibrary.dep.state.pa.us/dsweb/Get/Document-88925/363-2134-008.pdf>
- Philips, J.V., and S. Tadayon (USGS). 2006. Selection of Manning’s Roughness Coefficient for Natural and Constructed Vegetated and Non-Vegetated Channels, and Vegetation Maintenance Plan Guidelines for Vegetated Channels in Central Arizona: U.S. Geological Survey Scientific Investigations Report 20. <http://pubs.usgs.gov/sir/2006/5108/>
- Rosgen, David L. 1996. Applied River Morphology. Pagosa Springs, Colo: Wildland Hydrology.
- Saldi-Caromile, K., K. Bates, P. Skidmore, J. Barenti, D. Pine. 2004. Stream Habitat Restoration Guidelines: Final Draft. Co-published by the Washington Departments of Fish and Wildlife and Ecology and the U.S. Fish and Wildlife Service. Olympia, Washington.
- Schiff, R., J.G. MacBroom, and J. Armstrong Bonin, 2007, Guidelines for Naturalized River Channel Design and Bank Stabilization. NHDES-R-WD-06-37. Prepared by Milone & MacBroom, Inc. for the New Hampshire Department of Environmental Services and the New Hampshire Department of Transportation, Concord, N.H.
- Schueler, Tom, Bill Stack, et al. 2014. Recommendations of the Expert Panel to Define Removal Rates for Individual Stream Restoration Projects – Final Report.

- 
- Skidmore, P.B., C.R. Thorne, B.L. Cluer, G.R. Pess, J.M. Castro, T.J. Beechie, and C.C. Shea. 2011. Science base and tools for evaluating stream engineering, management, and restoration proposals. U.S. Dept. Commer., NOAA Tech. Memo. NMFS-NWFSC-112, 255 p.
- Soar, P.J., and Thorne, C.R. 2001. Channel Restoration Design for Meandering Rivers. ERDC/CHL CR-01-1, U.S. Army Engineer Research and Development Center, Flood Damage Reduction Research Program, Vicksburg, MS.
- Stream Restoration Design. By the Natural Resources Conservation Service (NRCS) 2007.
- Tennessee Department of Environment and Conservation. 2012. Erosion and Sediment Control Handbook. <http://tnepsc.org/handbook.asp>
- United States Census Bureau. 2016. "New Residential Construction: Building Permits Survey. Table 2au: New Privately Owned Housing Units Authorized Unadjusted Units for Regions, Divisions, and States. Data for 2014." <http://www.census.gov/construction/bps/txt/tb2u2014.txt>
- United States Department of Agriculture (USDA). 1968. Wind Erosion Forces in the United States and Their Use in Predicting Soil Loss. Agriculture Handbook 346. <http://naldc.nal.usda.gov/download/CAT10309179/PDF>
- United States Department of Agriculture - Agricultural Research Service (USDA-ARS). 1964. Protecting Trees Against Damage from Construction Work. Agriculture Information Bulletin 285.
- United States Department of Agriculture - Agricultural Research Service (USDA-ARS). 2008. Draft User's Reference Guide: Universal Soil Loss Equation Version 2 (RUSLE2). Washington, D.C.
- United States Department of Agriculture - Soil Conservation Service (USDA-SCS). 1970. Guidelines for the Control of Erosion and Sediment in Urban Areas of the Northeast. Upper Darby, Pa.
- United States Environmental Protection Agency (EPA). 2016. "District of Columbia Water Quality Assessment Report". Data from 2014. [https://iaspub.epa.gov/waters10/attains\\_index.control?p\\_area=DC](https://iaspub.epa.gov/waters10/attains_index.control?p_area=DC)
- Urban Tree Foundation. <http://www.urbantree.org/index.shtml>
- Virginia Department of Conservation and Recreation (DCR). 2004. The Virginia Stream Restoration and Stabilization Best Management Practices Guide. <http://www.deq.virginia.gov/Portals/0/DEQ/Water/Publications/BMPGuide.pdf>
- Virginia Department of Environmental Quality. 1992. Virginia Erosion and Sediment Control Handbook, Third Edition. <http://www.deq.virginia.gov/Programs/Water/StormwaterManagement/Publications/ESCHandbook.aspx>
-

Virginia Department of Environmental Quality. 2002. ESC Technical Bulletin #2 – Application of Anionic Polyacrylamide for Soil Stabilization and Stormwater Management. <http://www.deq.virginia.gov/Portals/0/DEQ/Water/Publications/ESCTechBulletin2.pdf>

Washington State Aquatic Habitat Guidelines Program. 2002. Integrated Streambank Protection Guidelines (ISPG). Olympia, Washington.

Wischmeier W. and D. Smith. 1978. Predicting Rainfall Erosion Losses: A Guide to Conservation Planning. United States Department of Agriculture, Washington, D.C.

Wohl, E., S. N. Lane, and A. C. Wilcox. 2015. The science and practice of river restoration, *Water Resour. Res.*, 51, 5974–5997, doi:10.1002/2014WR016874.

Woodruff, N. P., L. Lyles, F. H. Siddoway, and D. W. Fryrear. 1972. How to Control Wind Erosion. P. 22. USDA-ARS, Agriculture Information Bulletin 354.

# Appendix A      Material Specifications

## A.1 Geotextile Fabrics

The fabric must be inert to commonly encountered chemicals and hydrocarbons and must be rot and mildew resistant. It must be manufactured from fibers consisting of long chain synthetic polymers, and composed of a minimum of 85% by weight of polyolephins, polyesters, or polyamides. The geotextile fabric must resist deterioration from ultraviolet exposure.

In addition, Classes A through E must have a 0.01 cm/sec minimum permeability when tested in accordance with ASTM D-4491, and an apparent minimum elongation of 20% when tested in accordance with the grab tensile strength requirements listed in Table A.1.

The properties must be determined in accordance with the following procedures:

- Apparent opening size – ASTM D-4751.
- Grab tensile strength – ASTM D 4632: 4-inch by 8-inch specimen, 1-inch by 2-inch clamps, and a 12-inch per minute strain rate in both principal directions of geotextile fabric.
- Puncture Strength – ASTM D 4833.

**Table A.1 Geotextile Fabrics**

Application Class		Type of Geotextile	Grab Strength (lb) D 4632	Puncture Strength (lb) D 4633	Permittivity (sec <sup>-1</sup> ) D 4491	Apparent Opening Size (max, mm) D4751	Trapezoid Tear Strength (lb) D 4533
SD	Type I	Nonwoven	160	56	0.50	0.43	55
		Woven, Monofilament	250	90	0.50	0.43	90
	Type II	Nonwoven	160	56	0.20	0.25	55
		Woven, Monofilament	250	90	0.20	0.25	90
PE	Type I	Nonwoven	200	80	0.70	0.43	80
		Woven, Monofilament	250	90	0.70	0.43	90
	Type II	Nonwoven	200	80	0.20	0.25	80
		Woven, Monofilament	250	90	0.20	0.25	90
	Type III	Nonwoven	200	80	0.10	0.22	80
		Woven, Monofilament	250	90	0.10	0.22	90
SE		Nonwoven	200	80	0.20	0.30	80
		Woven	250	90	0.20	0.30	90
ST		Woven	300*	110	0.05	0.15**	110
F		Woven	100	-	0.05	0.60	-
E		Nonwoven	90	30	0.50	0.30	30

Note 1: All property values are based on minimum average roll values in the weakest principal direction, except for apparent opening size.

Note 2: The ultraviolet stability must be 50% after 500 hours of exposure for all classes, except Class F, which must be 70% (D 4355).

\* Minimum 15% elongation.

\*\*This is a MINIMUM apparent opening size, not a maximum.

## A.2 Silt Fence

Class F geotextile fabrics for silt fence must have a 50 lb/in minimum tensile strength and a 20 lb/in minimum tensile modulus when tested in accordance with ASTM D-4595. The material must also have a 0.3 gal/ft<sup>2</sup>/min flow rate and 75% minimum filtering efficiency when tested in accordance with ASTM D-5141.

Geotextile fabrics used in the construction of silt fence must resist deterioration from ultraviolet exposure. The fabric must contain sufficient amounts of ultraviolet ray inhibitors and stabilizers to provide a minimum of 12 months of expected usable construction life at a temperature range of 0 to 120 degrees F.



### A.3 Stone

Stone sizes must conform to the following tables.

**Table A.2 Stone Size**

Stone Classification	Size Range (inches)	d <sub>50</sub> (inches)	d <sub>100</sub> (inches)	AASHTO	Weight
Number 57*	3/8–1½	½	1½	M-43	N/A
Number 2	2–3	2-½	3	M-43	N/A
Number 1	2-4	3	4	M-43	N/A
<b>Riprap</b>					
Class 0**	4–7	5½	7	N/A	N/A
Class I	N/A	9½	15	N/A	150 lb max
Class II	N/A	16	24	N/A	700 lb max
Class III	N/A	23	34	N/A	2,000 lb max

\* This classification is to be used on the inside face of stone outlets and check dams.

\*\* This classification is to be used whenever small riprap is required.

**Table A.3 Stone for Gabion Baskets**

Basket Thickness		Size of Individual Stones	
inches	millimeters	inches	millimeters
6	150	3–5	75–125
9	225	4–7	100–175
12	300	4–7	100–175
18	460	4–7	100–175
36	910	4–12	100–300

NOTE: Recycled concrete equivalent may be substituted for all stone classifications. Recycled concrete equivalent must be concrete broken into the sizes meeting the appropriate classification, contain no steel reinforcement, and have a density of 150 pounds per cubic foot.

## A.4 Soil Texture

The soil textural triangle (Figure A.1) helps to determine the soil texture classification based on the fractions of clay, sand, and silt present in a soil sample.

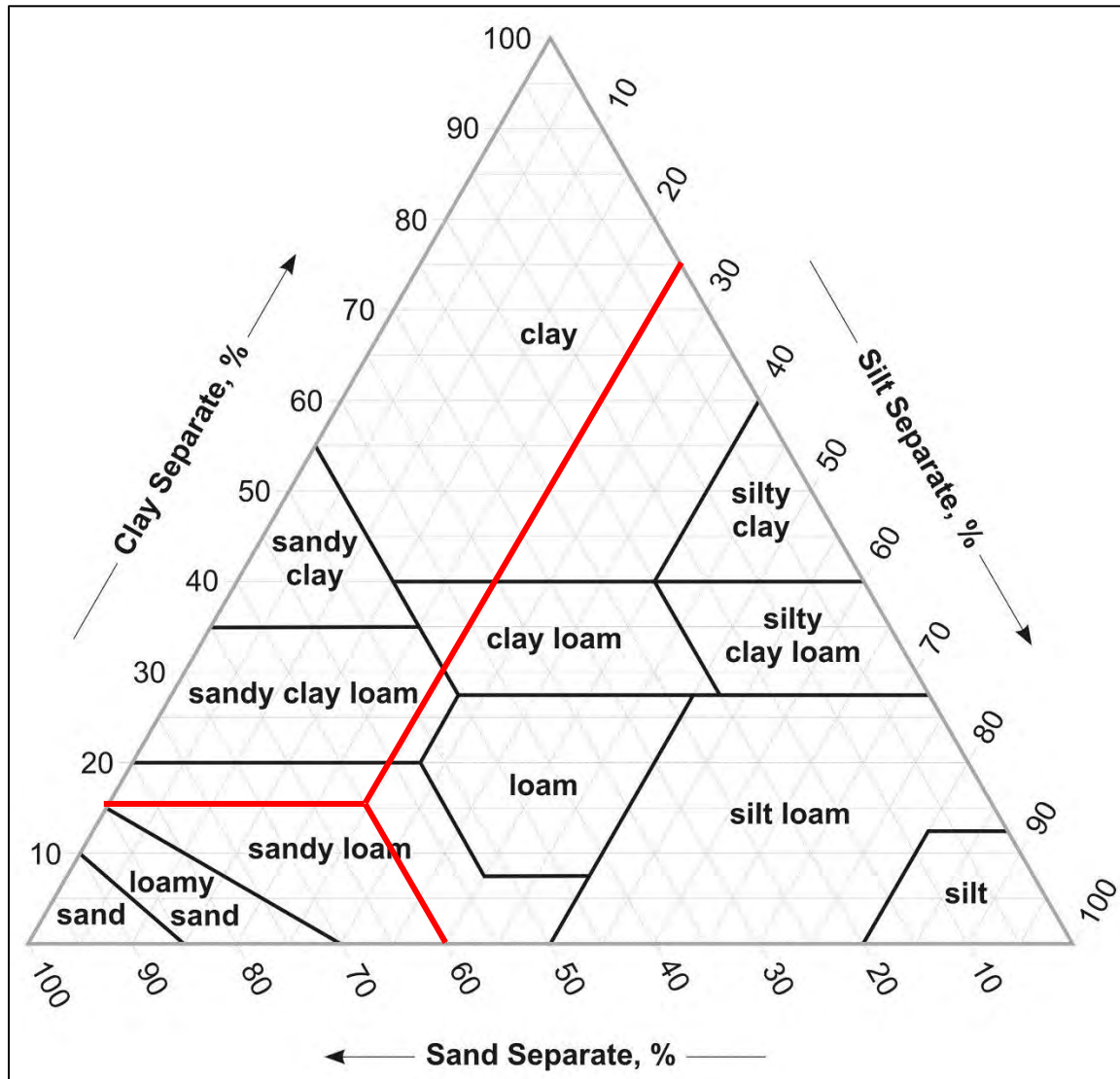

Figure A.1 Soil textural triangle.

For example, if the soil sample is 60% sand, 15% clay, and 25% silt, the soil type would be sandy loam.

# Appendix B Open Channel Hydraulics

## B.1 Introduction

There are several different methods for determining open channel flow characteristics and the factors needed to calculate open channel parameters. The most commonly known and widely used method is the Chezy-Manning equation and parameters. For the purpose of this manual, much of this method is simplified to allow practical application for projects of the scale seen in the District of Columbia.

## B.2 Manning's Equations for Open Channel Flow

### Velocity of flow in channel

US customary units:

$$V = \frac{1.49 \times R^{\frac{2}{3}} \times \sqrt{S}}{n}$$

SI units:

$$V = \frac{1.00 \times R^{\frac{2}{3}} \times \sqrt{S}}{n}$$

(eq. B.1)

Where:

- V = cross-sectional mean velocity (ft/s, m/s)
- n = Manning coefficient of roughness
- R = hydraulic radius (ft, m)
- S = slope of pipe (ft/ft, m/m)

### Capacity (volumetric flow rate) in channel

US customary units:

$$Q = \frac{1.49 \times A \times R^{\frac{2}{3}} \times \sqrt{S}}{n}$$

SI units:

$$Q = \frac{1.00 \times A \times R^{\frac{2}{3}} \times \sqrt{S}}{n}$$

(eq. B.2)

Where:

- Q = volume flow (ft<sup>3</sup>/s, m<sup>3</sup>/s)
- A = cross-sectional area of flow (ft<sup>2</sup>, m<sup>2</sup>)

Design capacity for any permanent channel must be at least a 15-year, 24-hour storm, with a 25% safety factor. Sensitive areas may require a higher standard.

### B.3 Variable Parameters

#### Slope

The longitudinal slope of the channel.

#### Area (A) and Hydraulic Radius (R)

Area and hydraulic radius depend on the depth of flow in a channel. For the recommended and most common cross-sectional shapes, the area (A), wetted perimeter (P), hydraulic radius (R), width at the top of design flow (T), and depth of channel (D) are as follows in Figure B.1.

- Area (A) is defined as the cross-sectional area of the flow.
- Wetted perimeter (P) is the linear distance water is in contact with the channel.
- Hydraulic radius (R) is the area (A) divided by the wetted perimeter (P).

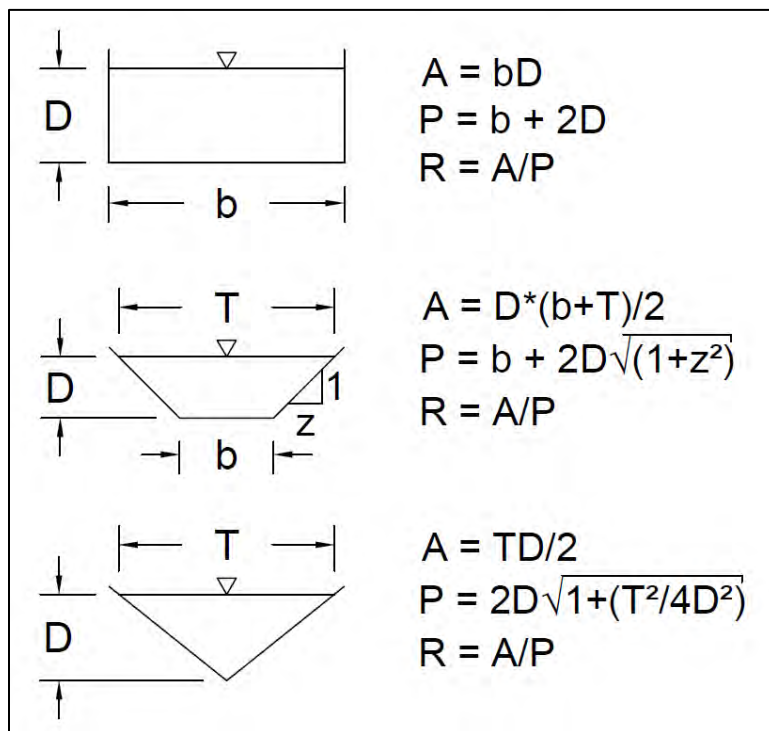

Figure B.1 Hydraulic parameters of basic channel sections.

Manning's Roughness Coefficient (n)

Manning's n-values are typically given as a range in tabular form. The n-value for a given lining material may depend on several factors, but the most significant is the flow depth relative to the roughness of the material. It is acceptable and advisable to use the median value in a given range; it is not necessarily more conservative to use one of the extreme values. If the flow depth is very shallow, the n-value will be higher, and vice versa.

**Table B.1 Manning's Roughness Coefficients (n)**

Material	n-value		
	Low	Median/Default	High
Bare earth	0.018	0.022	0.025
Short grass	0.025	0.03	0.035
Tall grass	0.03	0.035	0.05
Concrete			
Finished	0.011	0.015	0.016
Unfinished	0.014	0.017	0.02
Shotcrete	0.016	0.02	0.025
Gravel			
Riprap	0.034	Use equation B.3	0.055
Gabions	Use <i>n</i> for riprap or stone used to fill baskets/mattresses		

Adapted from (Chow, 1959; NRCS, NHCP, 2010; USGS, 2007)

Roughness coefficient for riprap-lined channel based on depth of flow and stone size

$$n = \frac{D^{\frac{1}{6}}}{21.6 \times \log_{10} \left( \frac{D}{d_{50}} \right) + 14.0} \quad (\text{eq. B.3})$$

Where:

- D = flow depth (ft)  
d<sub>50</sub> = median stone diameter (ft)

See Figure B.2 for a graph enabling visual determination of Manning's n for riprap based on flow depth and stone size.

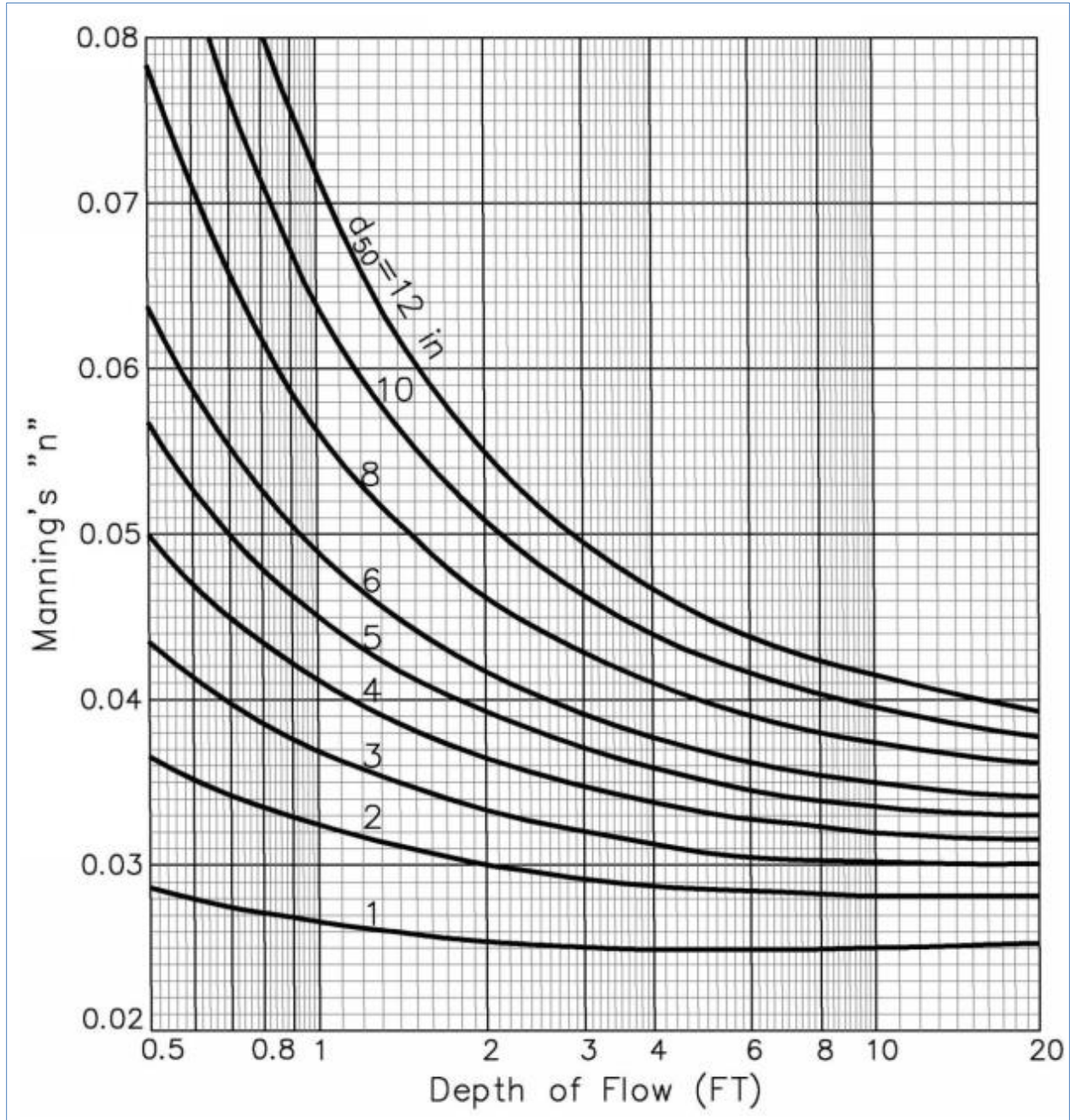

Figure B.2 Manning's roughness coefficient (n) based on flow depth and stone size.

Table B.2 gives the maximum permissible side slopes for common channel lining materials.

Table B.3 gives the maximum permissible velocities for various channel lining materials.

**Table B.2 Steepest Permissible Side Slopes and Minimum Lining Thickness**

Channel Type	Side Slopes	Minimum Lining Thickness
Turfgrass or seed with temporary stabilization matting	3:1	Per manufacturer specifications
Permanent soil stabilization matting	2:1	Per manufacturer specifications
Non-reinforced concrete Hand-placed, formed concrete Heights of lining, 1.5 feet or less	Vertical*	4 inches
Non-reinforced concrete Hand-placed, screened concrete or mortared-in-place flagstone Height of lining, less than 2 feet Height of lining, more than 2 feet	1:1 2:1	4 inches
Slip Form Concrete Height of lining, less than 2 feet	1:1	4 inches
Riprap	2:1	1-½ times maximum stone size plus thickness of filter or bedding
Gabion	Per manufacturer specifications or 2:1* if not specified.	Per manufacturer specifications

\*Monolithic concrete or gabion channels may be rectangular in cross section. For gabions, the vertical face on the side of a gabion basket would function as the vertical side slope.

**Table B.3 Maximum Permissible Velocities for Channel Lining Materials**

<b>Channel Lining Material</b>	<b>Allowable Flow Channel Velocity (feet/second)</b>
Bare soil (sandy loam, silty loam)	$\leq 1.5$
Bare soil (stable, cohesive)	$\leq 2.0$
Seed and mulch	$\leq 2.0$
Sod	$\leq 4.0$
Soil stabilization matting over seed and mulch	$\leq 6.0$
Grass with permanent soil stabilization matting	$\leq 8.0$
Gabions or Reno mattresses	Use $v$ for stone filling
Class 0 riprap	
Flow depth $\leq 1$ foot	$\leq 10.0$
Flow depth $\geq 1$ foot	$\leq 12.0$
Class 1 riprap	$\leq 14.0$
Class 2 riprap	$\leq 16.0$
Class 3 riprap	$\leq 20.0$
Concrete	See Figure B.3 (maximum 30 ft/s)
Flow depth ( $D$ ) $\leq 1$ foot	$-21.43D + 36.43$
Flow depth ( $D$ ) between 1 foot and 2 feet	$-5D+20$
Flow depth $> 2$ feet	$< 10$



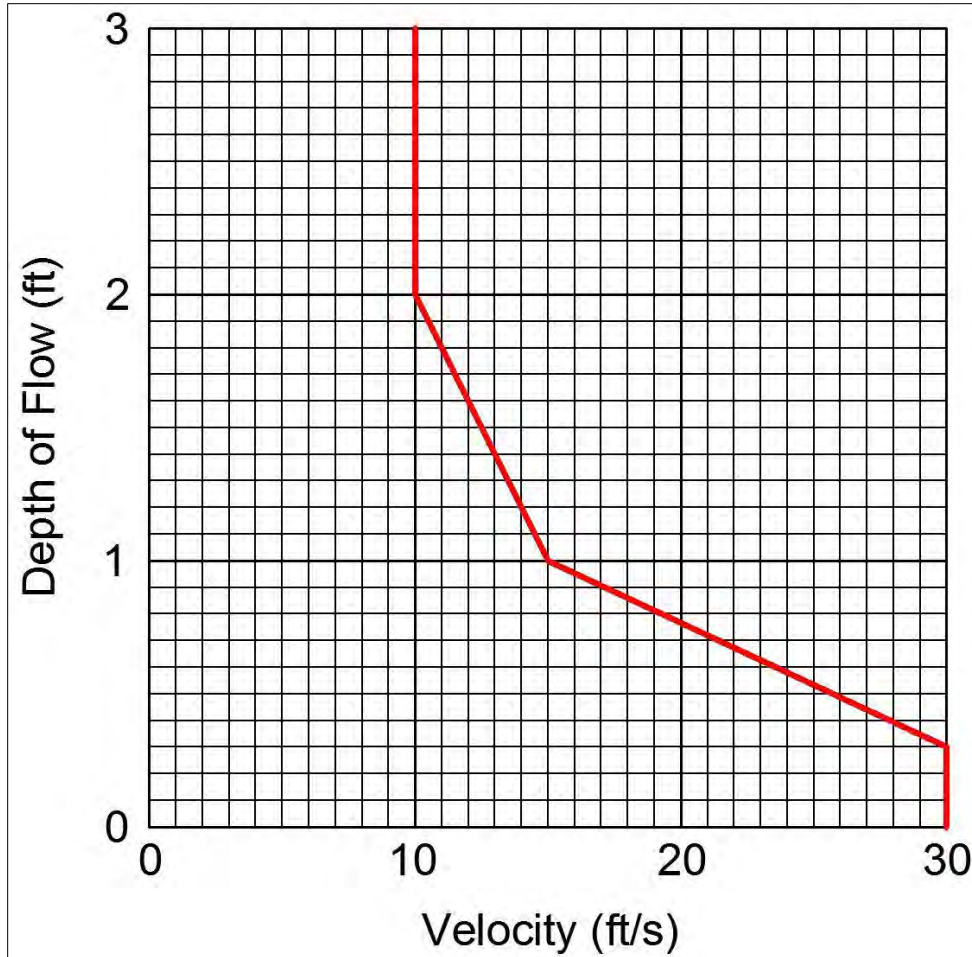

Figure B.3 Maximum flow velocity versus depth of flow for concrete-lined channels (image adapted from NRCS, NHCP 2010).

## B.4 Example Design Exercises

### Riprap/Gabion Channel Design Example

Given:

- Drainage area to channel is 4.1 acres, entirely impervious
- 15-year peak rainfall intensity for DC is 7.56 inches per hour
- Slope of the channel is 8.3% (0.083)

Solution:

1. Determine required capacity (Q)

There are multiple methods for approximating runoff from a site. Perhaps the two most common and well-known are TR-20/TR-55, and the Rational Method. While the TR-55 method is designated for small watersheds, typically in the District of Columbia sites will be

so small that even TR-55 is not particularly good for approximating runoff flow rates. For this reason, the Rational Method is recommended.

$$Q = c \times i \times A \times 1.25 \times 1.008$$

Where:

- Q = flow rate, in cubic feet per second (cfs)
- c = unitless runoff coefficient  
=  $(0.9 \times \text{impervious cover}) + (0.22 \times \text{pervious cover}) + 0.05$
- i = peak rainfall intensity in inches per hour (in/hr)
- A = contributing drainage area in acres (ac)

The 1.25 is the 25% safety factor. 1.008 is to convert acre-inches per hour to cfs.

- c =  $(0.9 \times 1) + 0.05 = 0.95$
- i = 7.56 inches per hour (15-year peak rainfall intensity for the District)
- A = 4.1 acres
- Q =  $(0.95 \times 7.56 \times 4.1) \times (1.25) \times (1.008) = 37.1$  cfs

## 2. Determine maximum velocity

Intended channel lining material is Class 0 riprap, which has a  $d_{50}$  of 5.5 inches. From Table B.3, the maximum flow velocity for depths up to 1 foot is 10 feet per second.

## 3. Chezy-Manning Equation

Start with the proposed geometry for the riprap/gabion channel in Section 4.5 Long-Term or Permanent Flumes/Chutes, flowing full depth at 1 foot. Check velocity against maximum permissible.

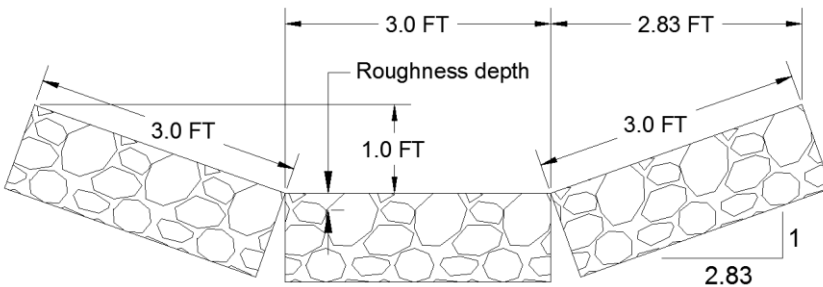

- b = 3 feet
- D = 1 foot
- z = 2.83 feet/foot (side slope of 2.83:1)
- T = 8.66 feet
- $d_{50}$  = 5.5 inches = 0.458 feet

$$A = D \times \frac{(b + T)}{2} = 5.83 \text{ ft}^2$$

$$P = b + 2D\sqrt{z^2 + 1} \text{ OR } 3 + 3 + 3 = 9 \text{ feet}$$

$$R = \frac{A}{P} = \frac{5.83 \text{ ft}}{9 \text{ ft}} = 0.648$$

$$n = \frac{D^{1/6}}{21.6 \times \log_{10} \left( \frac{D}{d_{50}} \right) + 14.0} = 0.047$$

(eq. B.3)

$$V = \frac{1.49 \times R^{2/3} \times \sqrt{S}}{n} = 6.84 \frac{\text{ft}}{\text{s}}$$

(eq. B.1)

$$Q = A \times V = 5.83 \text{ ft}^2 \times 6.84 \frac{\text{ft}}{\text{s}} = 39.9 \text{ cfs}$$

(eq. B.2)

This is greater than the 37.1 cfs required to meet 125% of the 15-year storm flow. It is important to note that this is the real capacity of the channel. For design purposes, due to the safety factor, this would be listed in Table 4.7 with the following site constraints:

**Table 4.7 Stone Flume Carrying Capacity (25% safety factor) (Excerpt)**

Slope	Maximum Flow (cfs)	Maximum Drainage Area (acres)
8.3% (12:1)	31.9	4.5

Comments:

Maximum velocity may constrain flow depth, which in turn may increase Manning's n-value, reducing the velocity further. This may lead to an iterative process to solve for uniform flow. An alternative to making a channel larger is often to put a more stable lining material in; larger stone can handle more runoff due to higher n values and greater maximum velocities.

Concrete Channel Design Example

Given:

- Drainage area to rectangular channel is 4.1 acres, entirely impervious
- 15-year peak rainfall intensity for Washington, DC is 7.56 inches per hour
- Slope of the channel is 8.3% (0.083)

Solution:

1. Determine required capacity (Q)

From prior example,  $Q = 37.1$  cfs

2. Determine maximum velocity

Intended channel lining material is slip-formed concrete. From Table B.3, the maximum flow velocity for depths less than 1 foot is given by the equation:

$$v = -21.43D + 36.43 \text{ (with a maximum velocity of 30 fps) or the graph in Figure B.3.}$$

3. Chezy-Manning Equation

Given Table 4.7 in Section 4.5 Long-Term or Permanent Flumes/Chutes the channel dimensions shown in the detail will not carry enough water.

**Table 4.7 Stone Flume Carrying Capacity (25% safety factor) (Excerpt)**

Slope	Maximum Flow (cfs)	Maximum Drainage Area (acres)
5% (20:1)	24.7	3.4
10% (10:1)	35.0	4.9

One option is to install two such channels to achieve the necessary capacity. This example shows how to design one channel with the complete carrying capacity required.

Start with an assumed cross section:

- b = 4 feet (starting assumption)
- D = 1 foot (design maximum)
- A = Db
- = 4 ft<sup>2</sup> (starting assumption - max)
- P = b + 2D
- = 6 feet
- R = A/P
- = 4 feet / 6 feet = 0.67
- n = 0.015 (from Table B.1)

$$\begin{aligned}v &= (k/n) R^{(2/3)} S^{(1/2)} \\ &= 21.8 \text{ ft/s} \quad (\text{eq. B.1})\end{aligned}$$

Maximum velocity for 1 foot flow depth is 15 ft/s. Choose another depth to try.

$$\begin{aligned}d &= 0.7 \text{ feet} \\ A &= 2.8 \text{ ft}^2 \\ P &= 5.4 \text{ feet} \\ R &= 0.52 \\ v &= 18.5 \text{ ft/s}\end{aligned}$$

This is an acceptable velocity for concrete at this flow depth.

$$Q = 47.8 \text{ cfs} \quad (\text{eq. B.2})$$

This is greater than the 37.1 cfs required.

Comments:

This outlines the sometimes iterative process necessary to coordinate  $n$ ,  $v$ ,  $D$ , and the material constraints. A simple spreadsheet set up to calculate these parameters allows quick iteration. The same process/method works for any of the channel shapes listed in Figure B.1, but the various parameters ( $b$ ,  $D$ ,  $z$ ,  $A$ ,  $P$ ,  $R$ ) used in the calculations differ.

### Grass-Lined Channel Design Example

Given:

- Drainage area to channel is 4.1 acres, entirely impervious
- 15-year peak rainfall intensity for Washington, DC is 7.56 inches per hour
- Slope of the channel is 8.3% (0.083)

Solution:

Referring to Table 4.6 in Section 4.4 Temporary Swales, swale type A-3 is the minimum standard that will meet the slope and drainage area constraints. Swale type A-3 is a stone-lined channel.

**Table 4.6 Temporary Swale Selection Criteria**

Slope %	Drainage Area (acres)									
	1	2	3	4	5	6	7	8	9	10
1	[1] Seed and mulch					4		B-2		
2	A-1		4	4	4					
3		4							6	6
4			[2] Seed and soil stabilization matting					6		
5	4*						6		B-3	
6			A-2			6				
7					6					
8				6			[3] 4- to 7-inch stone pressed into ground (7 inches min.)			
9					A-3					
10			6*							



\*Velocity of flow in feet/second

Therefore, the cross-sectional geometry must be greater than those specified.

1. Determine required capacity (Q)

$$Q = 37.1 \text{ cfs (from prior examples)}$$

2. Determine maximum velocity

Intended material lining is seed and mulch with temporary soil stabilization matting.

$$v_{\max} = 6 \text{ feet/second}$$

3. Chezy-Manning equation

$$n = 0.03 \text{ (from Table B.1)}$$

By iterating to find the appropriate flow depth and channel width, and checking for maximum velocity, one finds that the minimum base width is 21 feet. This is likely not practical, and suggests that a lining material is required.

Comments:

Grass-lined channels are best limited to those specified in Section 4.4 Temporary Swales. There are limited applications for grass-lined channels for larger drainage areas and slopes.





## Appendix C      Definitions

AASHTO - American Association of State Highway & Transportation Officials

Anti-seep collar - An impermeable diaphragm usually of sheet metal or concrete constructed at intervals within the zone of saturation along the conduit of a principal spillway to increase the seepage length along the conduit and thereby prevent piping or seepage along the conduit.

Anti-vortex device - A device designed and placed on the top of a riser or at the entrance of a pipe to prevent the formation of a vortex in the water at the entrance.

Apron - A floor or lining to protect a surface from erosion, for example, the pavement below chutes, spillways, or at the toes of dams.

Base flow - The stream discharge from ground water accretion.

Best management practice (BMP) - Structural or non-structural practice that minimizes the impact of stormwater runoff on receiving waterbodies and other environmental resources, especially by reducing runoff volume and the pollutant loads carried in that runoff.

Building permit - Authorization for construction activity issued by the District of Columbia Department of Consumer and Regulatory Affairs.

Clearing - The removal of trees and brush from the land excluding the ordinary mowing of grass, pruning of trees, or other forms of long-term landscape maintenance.

Common plan of development - Multiple, separate, and distinct land-disturbing, substantial improvement, or other construction activities taking place under, or to further, a single, larger plan, although they may be taking place at different times on different schedules.

Construction - Activity conducted for the:

- (a) Building, renovating, modifying, or razing of a structure; or
- (b) Movement or shaping of earth, sediment, or a natural or built feature

Construction general permit (CGP) - An NPDES general permit that regulates stormwater discharges from construction activities that disturb one or more acres, or smaller sites that are part of larger common plan of development or sale that disturb one or more acres.

Cut - An act by which soil or rock is dug into, quarried, uncovered, removed, displaced, or relocated and the conditions resulting from those actions.

Demolition - The removal of part or all of a building, structure, or built land cover.

Department - The District of Columbia Department of Energy and Environment or its agent.

Dewatering - Removing water from an area or the environment using an approved technology or method, such as pumping.

DCMR - The District of Columbia Municipal Regulations.

DDOT - The District Department of Transportation.

Director - The Director of the Department of Energy and Environment.

District - The District of Columbia.

Disturbed area - An area in which the natural vegetative soil cover has been removed or altered and is susceptible to erosion.

DOEE - The Department of Energy and Environment.

EPA - The United States Environmental Protection Agency.

Erosion - The process by which the ground surface, including soil and deposited material, is worn away by the action of wind, water, ice, or gravity.

Erosion and sediment control (ESC) - Devices and conservation measures used to reduce or eliminate soil particles from leaving a land area.

Excavation - An act by which soil or rock is cut into, dug, quarried, uncovered, removed, displaced, or relocated and the conditions resulting from those actions.

Exposed area - Land that has been disturbed or land over which unstabilized soil or other erodible material is placed.

Grading - Causing disturbance of the earth, including excavating, filling, stockpiling of earth materials, grubbing, root mat or topsoil disturbance, or any combination of them.

Limits of disturbance (LOD) - The boundary within which all land grading, construction, landscaping, and related activities occurs.

National Pollutant Discharge Elimination System (NPDES) - The NPDES permit program addresses water pollution by regulating point sources that discharge pollutants to the waters of the United States.

Notice of intent (NOI) - A form required for authorization of coverage under the Construction General Permit.

Peak discharge - The maximum rate of flow of water at a given point and time resulting from a storm event.

**Public right-of-way (PROW)** - The surface, the air space above the surface (including air space immediately adjacent to a private structure located on public space or in a public right-of-way), and the area below the surface of any public street, bridge, tunnel, highway, lane, path, alley, sidewalk, or boulevard.

**Raze** - The complete removal of a building or other structure down to the ground.

**Responsible person** - Construction personnel knowledgeable in the principles and practices of soil erosion and sediment control and certified by a Department-approved soil erosion and sedimentation control training program to assess conditions at the construction site that would impact the effectiveness of a soil-erosion or sediment-control measure on the site.

**Runoff** - That portion of precipitation (including snow-melt) which travels over the land surface, and also from rooftops, either as sheetflow or as channel flow, in small trickles and streams, into the main water courses.

**Safety and Data Sheet (SDS)** - A document providing guidance on handling a hazardous substance, along with its composition and physical and chemical properties.

**Sediment** - Soil, including soil transported or deposited by human activity or the action of wind, water, ice, or gravity.

**Sedimentation** - The deposition or transportation of soil or other surface materials from one place to another as a result of an erosion process.

**Soil** - All earth material of whatever origin that overlies bedrock and may include the decomposed zone of bedrock which can be readily excavated by mechanical equipment.

**Soil erosion and sediment control plan** - A set of drawings, calculations, specifications, details, and supporting documents related to minimizing or eliminating erosion and off-site sedimentation caused by stormwater on a construction site. It includes information on construction, installation, operation, and maintenance.

**Soils report** - A geotechnical report addressing all soil erosion and sediment control-related soil attributes, including but not limited to site soil drainage and stability.

**Stormwater management plan** - A set of drawings, calculations, specifications, details, and supporting documents related to the management of stormwater for a site, which includes information on construction, installation, operation, and maintenance.

**Stormwater pollution prevention plan (SWPPP)** - A document that identifies potential sources of stormwater pollution at a construction site, describes practices to reduce pollutants in stormwater discharge from the site, and may identify procedures to achieve compliance.